

# TFC COMMANDER

UNIVERSAL IRRIGATION REMOTE CONTROL

## Operation and Installation Manual



# TFC Irrigation Remotes



## FCC REGULATIONS

The user of this remote control device does **not** need an FCC license.

The Receiver has been tested and found to comply with the limits for a Class A digital device, pursuant to Part 15 of the FCC Rules. The Transmitter has been tested and found to comply with Part 95 Subpart E. These limits are designed to provide reasonable protection against harmful interference when the equipment is operated in a commercial environment.

Canadian Certification #32151021261

# INTRODUCTION

Congratulations! You have just purchased the most advanced irrigation remote control available - the **TRC Commander**.

We welcome you to the growing family of thousands of satisfied TRC Irrigation Remotes product users who appreciate the importance of high standards, product quality and timely service.

The TRC Commander is TRC Irrigation Remotes' 6th generation of remote control products introduced since 1982. All of our remote control products do not require site surveys, base stations or FCC licensing.

# WARRANTY

All TRC Irrigation Remotes' products carry a "THREE YEAR WARRANTY".

For three years from the date of purchase. TRC Irrigation Remotes will repair or replace any of its products or parts to be found defective as to workmanship or materials. This warranty does not extend to damage to a TRC Irrigation Remotes product resulting from misuse, neglect or abuse, improper installation or accident.

This warranty extends only to an original user of TRC Irrigation Remotes product(s). In no event shall TRC Irrigation Remotes be liable for incidental or consequential damages. All implied warranties are limited in duration to three years following date of purchase. These exclusions or limitations apply only in those states where permitted by law.

# Models and Description

## Transmitter

**TRC Commander Transmitter** is the hand-held part of your remote system. Any 24VAC solenoid valve sprinkler system equipped with a TRC Universal Receiver or TRC Permanent Receiver Card can be operated with this Transmitter. The Transmitter operates on one 9-volt alkaline replaceable battery.

**Note: The battery must be alkaline or the transmitter will not operate.**

## Receivers

**Universal 32 Station DCI Receiver** is compatible with all 24VAC solenoid valve sprinkler systems and is capable of operating 32 stations per controller. This portable Receiver connects easily with a permanent connector hard wired to the terminal strip and a custom housing mounted on the controller for quick plug in.

**Permanent Receiver Cards** install easily and permanently into the controller. Installing Permanent Receiver Cards allows all zones of the controller to be operated. Each Card comes with internal and external antennas w/mounting hardware. Maximum range is achieved by installing the external antenna to the controller cabinet.

# Special Features

- **Connects to any 24VAC sprinkler system**
- **Silent Running**
  - Turn off all of the zones from 1 - 7 days
- **Adjustable Time Duration**
  - 2 Minutes to 2 Hours (default 20 minutes)
- **Multiple Receiver operation from a single Transmitter**
  - Field programmable dipswitches offer  
199 unique Receiver numbers
- **Programmable security codes**
  - 9999 different security group codes
- **Audible low power indicator**
  - Field replaceable 9 volt battery
- **Master Valve disable key**
  - Pump Start/Master Valve

**Permanent Receiver Cards are available for the following controllers:**

Rain Bird ESP MC® (NOT Compatible with SAT Controllers)

Rain Bird ESP LX®

Irritrol Dial & MC®

Superior Sterling®

HIT Logic 2 & 3®

Griswold IDC®

Weathermatic®

Hunter®

## Getting To Know The Transmitter

The TRC Commander Transmitter sends a proprietary FM signal to the Commander Receiver(s) turning on or off selected valves. With each valve activation or deactivation, the Pump Start/Master Valve station, when used, is automatically turned on or off unless "MV Off" has been pressed.

The Transmitter is designed for minimal power consumption to extend the life of the battery. The Transmitter power is normally off. Once any key has been pressed, power is automatically turned on for about ten seconds to allow your command sequence to be completed before the Transmitter automatically turns the power off and erases the command sequence from memory.

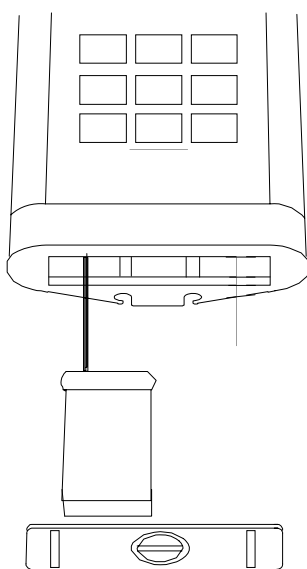

Transmitter uses one replaceable **9V Alkaline**

## The Transmitter Key Pad

The Commander Transmitter keypad has an audible beep to clearly indicate when a key is pressed. The Transmitter will beep once when a Number Key or the Receiver Number Key is pressed. The Transmitter will beep twice, with about two seconds between beeps, after a transmit key is pressed for ("VALVE ON", "VALVE OFF", "AUTO UP", "AUTO BACK", "M-V OFF" or "TIME"). The first beep indicates that the transmission is starting, and the second beep indicates that transmission has been completed.

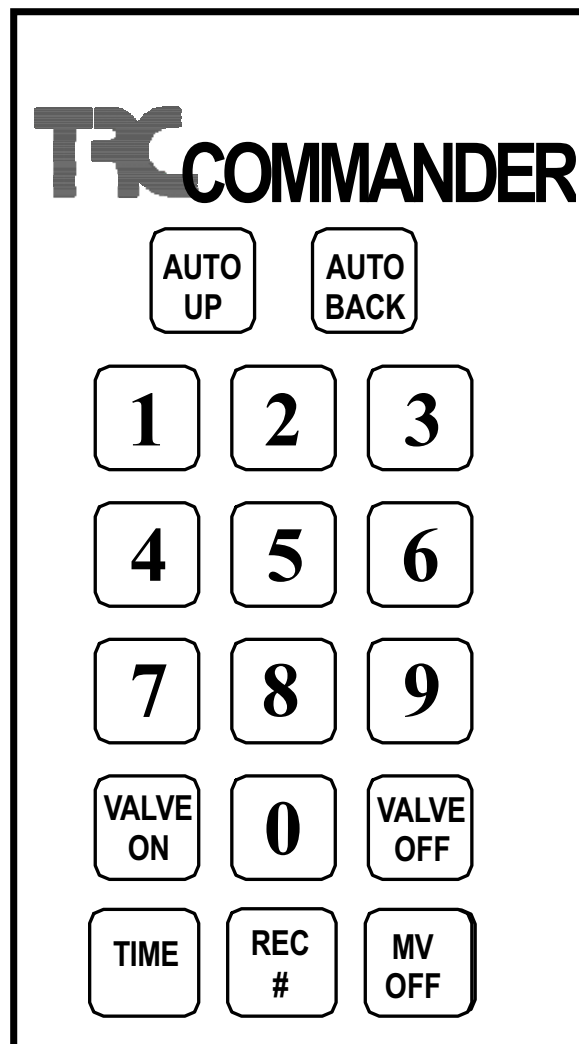

## Transmitter Operating Instructions

### Error Tone

You will hear a “squawk” error tone if an incorrect series of keys has been pressed. When the error tone is heard, wait 10 seconds and simply restart the series of commands.

### Low Battery Tone

A rapid sequence of beeps after the transmission beep indicates low battery power. **Replace with a new alkaline 9V battery.**

### Valve On/Valve Off

To turn a valve on press the desired zone number then press the "Valve On" key. Pressing "Valve Off" will turn off the last zone activated.

When "Valve Off" is pressed by itself the current zone will turn off. To turn that zone back on just press "Valve On". The Transmitter remembers which valve you were testing.

Pressing "0", "Valve Off" will turn off all zones.

### Example:

To turn on valve 3:



To turn off valve 3:



Turns zone 3 back on:





### Auto Up/Auto Back

These functions allow forward and backward advancement through each station. This will turn on the next sequential station number.

To operate press:

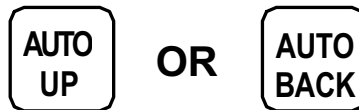

### Multiple Zones

Press the "9" key before a two digit zone number to turn on a multiple zone. Example: "903", "Valve On" will turn zone 3 on. You may have up to six multiple zones on at a time and a single zone plus a master valve. Multiple zones cannot be changed by the "Auto Up" or the "Auto Back" functions, but they can have an independent time duration.

A station registered for multiple mode operation will **not** be turned off automatically when other stations on the same Receiver are turned on. Also, the single mode station will **not** be automatically turned off when multiple mode stations are turned on. If you try to turn on a seventh multiple mode valve, the first multiple mode valve turned on will be automatically turned off.

**WARNING:** Make sure your controller has adequate power to operate the number of multiple stations you intend to have on at one time. Otherwise, you may overload the circuit breaker at your controller.

Adding zone 2:



Adding zone 32:



To turn all zones off:

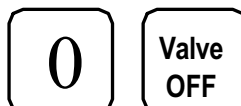









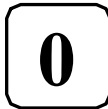

## Time Duration

You can set a time duration anywhere from two minutes to two hours.

Press three digits of time in the following format:

Hour, Tens Minutes, Minutes. The range of allowed entries for time duration is from two minutes "002" to two hours "200". Then press the "Time" key, followed by the desired zone # and then "Valve On."

	Hour	Tens	Minutes	
For 2 minutes:				
For 20 minutes:				
For 2 Hours:				

## Master Valve Off

When a valve station is activated the Pump Start/Master Valve is automatically enabled by the Receiver. To disable the Master Valve press the "MV Off" key. Pressing the "MV Off" key again prior to turning on any stations at a Receiver will turn the Master Valve back on.

Note: Using "99" "Valve On" to manually operate the Pump Start/Master Valve will override the "MV Off" function. It will also run the Master Valve/Pump Start continuously.

To disable the Master Valve:



### Operating the Pump Start/Master Valve

When in the automatic mode, the Pump Start/Master Valve is automatically activated when a valve station is turned on. You can manually turn on the Pump Start/Master Valve by pressing "99" "Valve On". IF YOU MANUALLY TURN ON THE PUMP START/MASTER VALVE STATION, YOU MUST MANUALLY TURN IT OFF AGAIN. There is no default time with this function. The Pump Start/MV will stay on until "0" "Valve Off" or "99" "Valve Off" command is received. Press the two digits "99" "Valve On" to select only the Pump Start/Master Valve station. To turn off the pump start/master valve station press the two digit "99" "Valve Off" key to deactivate.

To turn Master Valve off:



To turn Master Valve on:



### Receiver Number

The TRC Commander Transmitter can operate as many as 199 Permanent Receivers on each group code. To designate Receiver press a desired Receiver number and "Rec #" key.

Setting to Receiver number 3:



## **Silent Running Feature (Rain Off)**

This feature allows user to shut down the controller remotely by disconnecting valve common similar to a rain switch. The controller can be disabled for 1 to 7 days or indefinitely.

The Receiver Card interrupts the signal from the controller to the valves and shuts the system down without having to change programming. Pressing "9" then the desired number of days, then "Valve Off" will program the Silent Running feature.

### **Silent Running (Rain Off) codes:**

<b>90 Valve Off</b>	<b>Infinite</b>
<b>91 Valve Off</b>	<b>1 Day</b>
<b>92 Valve Off</b>	<b>2 Days</b>
<b>93 Valve Off</b>	<b>3 Days</b>
<b>94 Valve Off</b>	<b>4 Days</b>
<b>95 Valve Off</b>	<b>5 Days</b>
<b>96 Valve Off</b>	<b>6 Days</b>
<b>97 Valve Off</b>	<b>7 Days</b>
<b>0 Valve Off</b>	<b>Clear</b>

Pressing "0" then "Valve Off" will clear all and reset the Receiver Card, erasing all Silent Running programs.

## Reprogramming the Transmitter

You must first wait at least 10 seconds after any key has been pressed before reprogramming. The following example reprograms the Transmitter to the factory defaults. **YOU DO NOT NEED TO CHANGE ANYTHING TO MAKE YOUR UNITS OPERATE!**

Step 1: 

8	8	5	2	1	4	1	REC #
---	---	---	---	---	---	---	-------

Step 2: 

0	0	0	1	REC #
---	---	---	---	-------

Step 3: 

1	REC #
---	-------

**Step 1** gives you access to the Transmitter's memory. **Step 2** sets the Group Code to "0001". **Step 3** sets the Receiver Number to "1".

The units come from the factory set to communicate with each other on Group Code #1, and Receiver #1. **YOU DO NOT NEED TO CHANGE ANYTHING TO MAKE YOUR UNITS OPERATE!**

*You only need to reprogram your Transmitter if you change the dipswitch settings on the Receiver. If you choose to do so, you will need to follow the steps above, making sure you change the Group Code and Receiver Number (steps 2 and 3) to match that of the Receivers, as explained on the next page.*

If the battery is removed for more than 2 minutes (or if it has died) you only have to reprogram the Transmitter if you have previously changed your Group Code or Receiver Number settings from the factory defaults. The Transmitter will remember the Group Code and Receiver Number for approximately 2 minutes with battery removed for replacement.

## Setting The Receiver's Dip Switches

***YOU DO NOT NEED TO CHANGE ANYTHING TO MAKE YOUR UNITS OPERATE!*** The units come from the factory set on Group Code # 1, Receiver # 1. If you change the dipswitches, you must reprogram your transmitter to the same settings, as explained on the previous page.

Should you be using multiple receivers in close proximity to each other, or if you are getting interference from someone else's remote, you may need to change your Group Code # or Receiver # dipswitch settings to prevent unwanted interference as follows:

**To Change the Receiver #:** Remove the four phillips head screws and separate the Receiver case to expose the Receiver number dipswitch set. Look on the back of the Receiver board; you will see three boxes of dipswitches as shown in the photo (Example 1). The dipswitches are exposed on the circuit board on Permanent Receiver Cards (Example 2). The Receiver # switch set is the box on the far right. ***The switches are read from right to left***, (see below) and are grouped in sets of four. Adding the numbers of the depressed switches together in each set of four will give you the total for that digit.

**To Change the Group Code #:** The Group Code switch set is the middle and left-hand boxes. ***These switches also read from right to left***, starting with the middle box and working toward the left (see below) and are also grouped in sets of four. Adding the numbers of the depressed switches together in each set of four will give you the total for that digit.

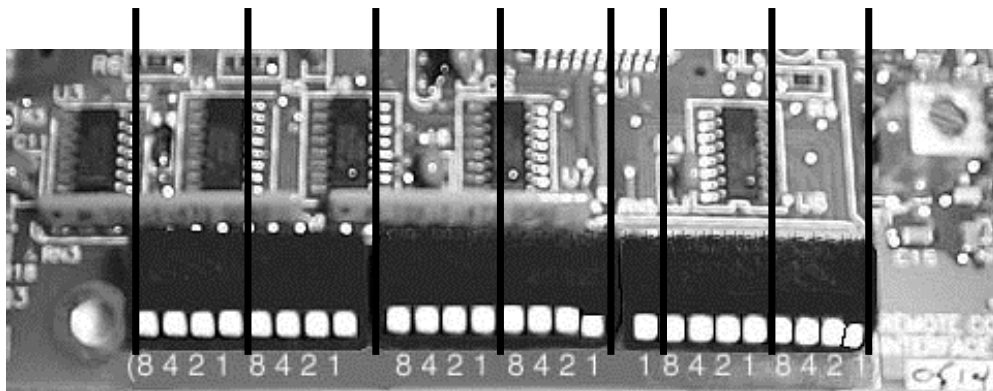

EXAMPLE 1: *Factory Default - Universal Receiver shown*  
Group Code Switch Set is switched to **Group Code #1**,  
Receiver Switch Set is switched to **Receiver #1**

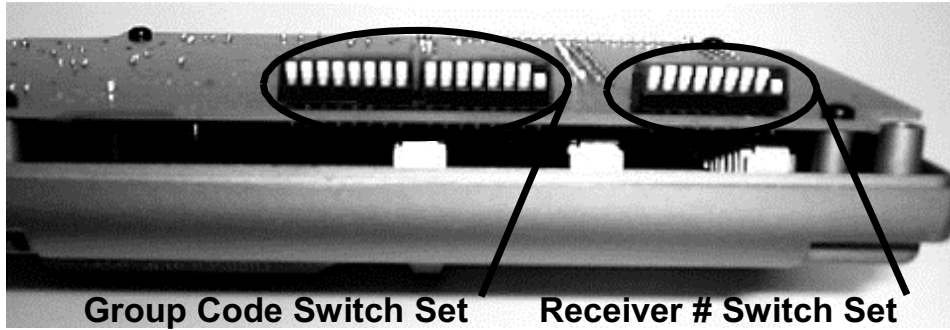

EXAMPLE 2: *Factory Default - Permanent Receiver Card shown*  
Group Code Switch Set is switched to **Group Code #1**,  
Receiver Switch Set is switched to **Receiver #1**

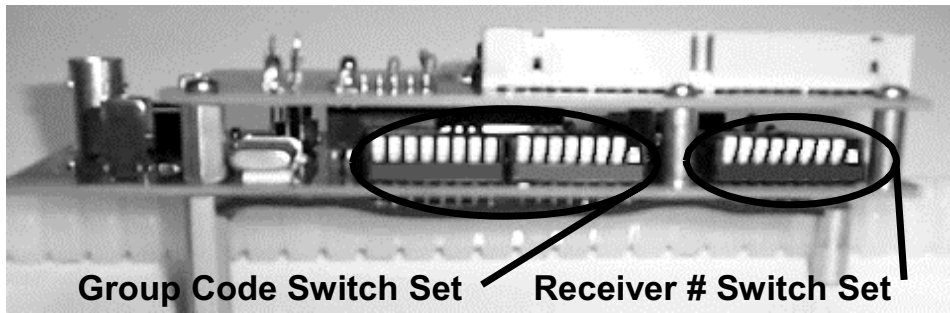

EXAMPLE 3: *Permanent Receiver Card shown*  
Group Code Switch Set is switched to **Group Code #1**,  
Receiver Switch Set is switched to **Receiver #2**

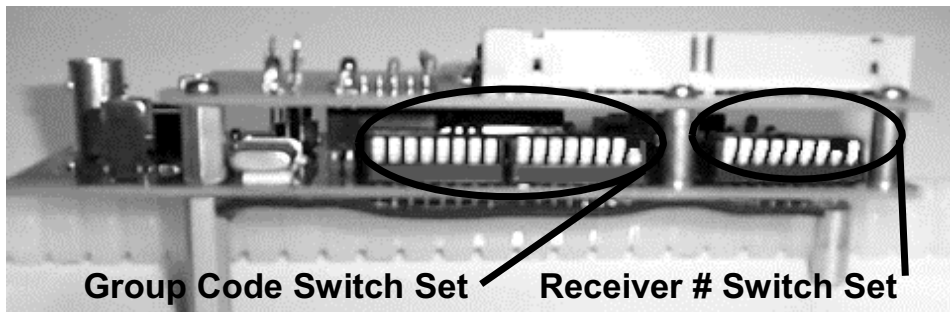

EXAMPLE 4: *Permanent Receiver Card shown*  
Group Code Switch Set is switched to **Group Code #2**,  
Receiver Switch Set is switched to **Receiver #3**

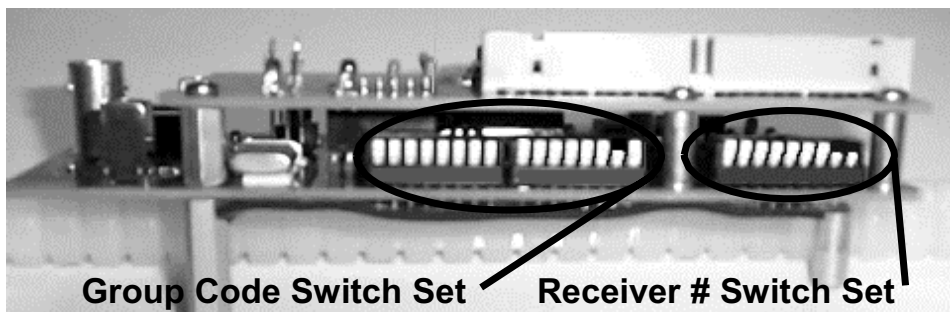

# Receiver Card for the Rain Bird® ESP MC

## Installation Instructions:

- Step 1: **Remove power from controller first!**
- Step 2: Unplug the ribbon cable from the main circuit board.
- Step 3: Connect the Receiver Card into the socket on the main circuit board where the ribbon cable was removed.
- Step 4: Plug the ribbon cable in the gray connector on Receiver Card.
- Step 5: Connect the antenna to the BNC fitting on the Receiver Card or connect the external mount antenna with coax cable for max. range.
- Step 6: Re-apply power to your controller.

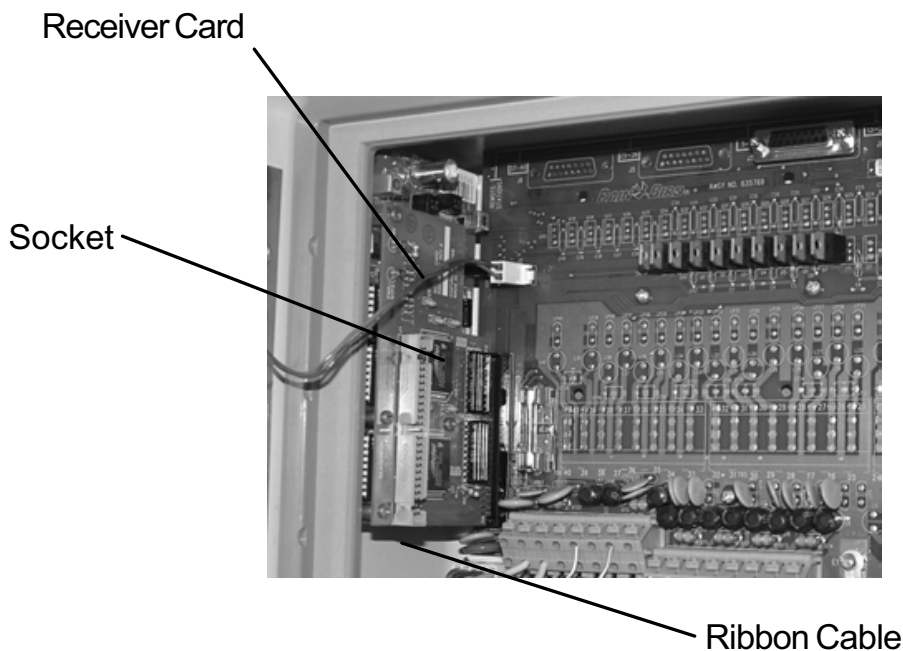



# Receiver Card for the Rain Bird® ESP LX

## Installation Instructions:

- Step 1: **Remove power from controller first!**
- Step 2: Unplug the ribbon cable from the main circuit board.
- Step 3: Connect the Receiver Card into the socket on the main circuit board where the ribbon cable was removed.
- Step 4: Plug the ribbon cable in the gray connector on Receiver Card.
- Step 5: Route the antenna cable out of the bottom of the controller and attach it on the left side of the outer controller housing with the Velcro supplied on the antenna.
- Step 6: Re-apply power to your controller.

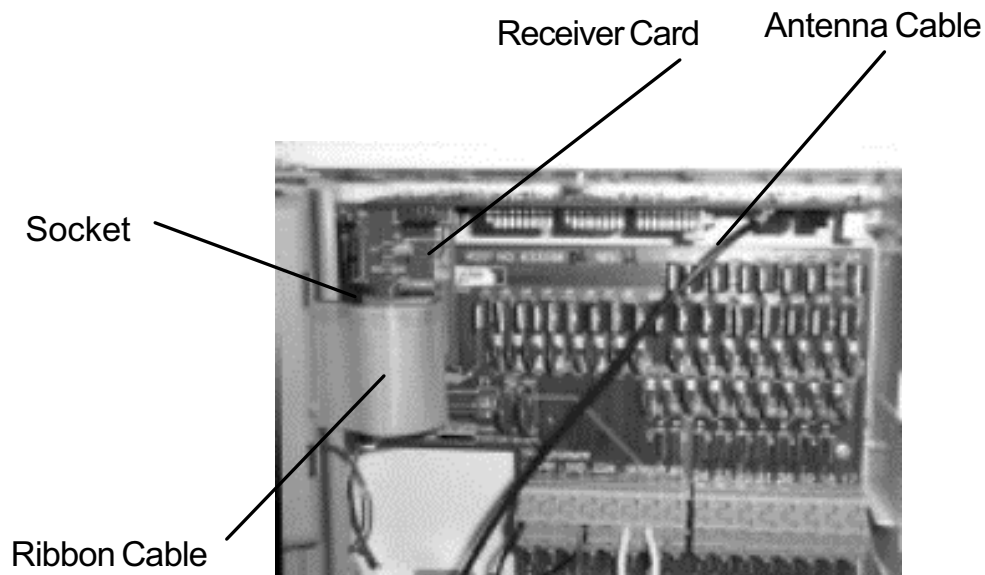

# Receiver Card for the Hunter<sup>®</sup> ICC<sup>®</sup>

## Installation Instructions:

- Step 1: **Remove power from controller first!**
- Step 2: Open the front panel door of the controller and clean the bottom inner portion of the door.
- Step 3: Remove the backing paper from the double-sided tape on the back of the Receiver Card and firmly place the Card onto the spot you have just cleaned. (BNC antenna mount lines up toward the left as illustrated in **fig.1** below).
- Step 4: Connect the 3 wires to the terminals in the upper left module on the back panel of the controller as follows: (See **fig.2**).  
Blue: to the REM terminal (sometimes labeled simply "R")  
White: to the upper AC terminal  
Red: to the lower AC terminal
- Step 5: Connect the antenna to the BNC fitting on the Receiver Card (Make sure the antenna points upward as illustrated in **fig. 1** below). For additional range, install the top mount antenna w/coaxial cable into the top of the controller (see antenna mounting instructions in the top-mount antenna kit).
- Step 6: Mount the adhesive "wire tie-down" to the right side of the inner door panel (see **fig.1**) and route the wires and cable through it, leaving slack so that NO strain is placed on wires when door is being opened.
- Step 7: Re-apply power and check the remote for operation.

Fig. 1

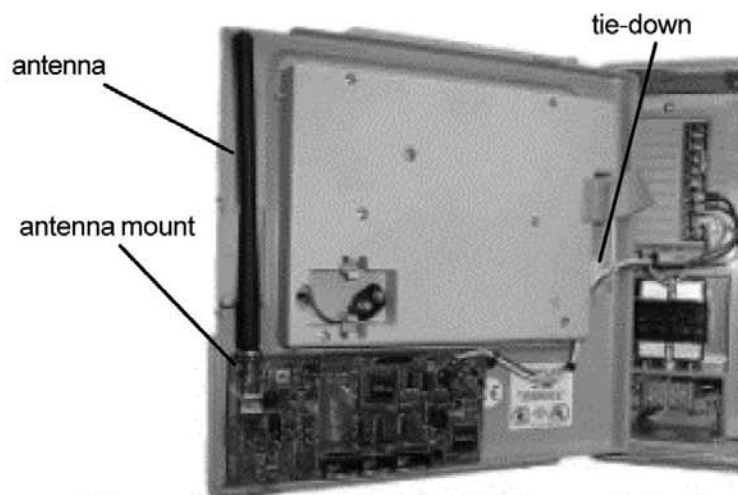
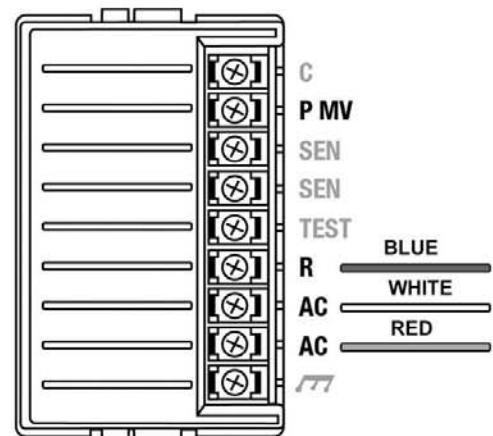

Fig 2



# Receiver Cards for the Superior Sterling®

## Installation Instructions:

- Step 1: **Remove power from controller first!**
- Step 2: Remove the controller faceplate by unscrewing the cross-recessed screws on each side.
- Step 3: Clean upper left, inner side panel (inside controller, behind front panel). Remove the backing from the tape on the back of the Receiver Card and firmly press the Card onto the spot you just cleaned. (Not illustrated here).
- Step 4: Connect the interface cable (with white connector) from the Card into the six pin molex connector on the back right-hand side of controller face (not illustrated here).
- Step 5: Connect the antenna to the BNC fitting on the Receiver Card or connect the external mount antenna with coax cable for max. range.
- Step 6: Connect all of your field common wires to the silver screw terminal on the card, then connect the black wire on the Card to a "valve common" terminal on the controller.
- Step 7: Re-install the controller face plate.
- Step 8: Re-apply power and check the remote for operation.

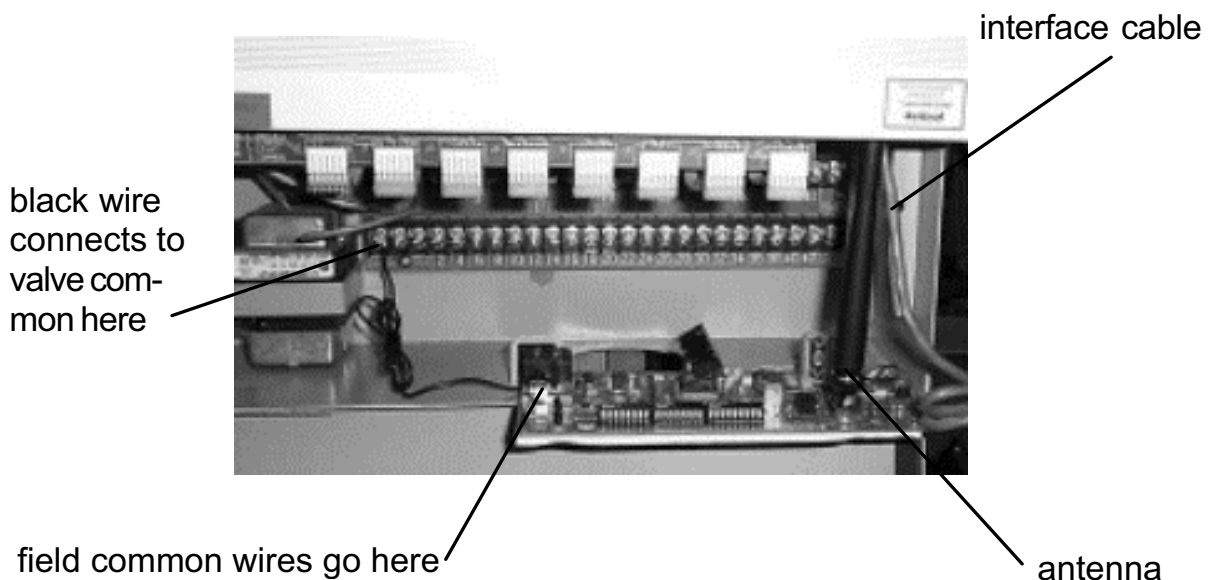

# Receiver Cards for the Irritrol® MC and Dial

## Installation Instructions:

- Step 1: **Remove power from controller first!**
- Step 2: Remove the controller faceplate by unscrewing the cross-recessed screws on each side.
- Step 3: Clean upper left, inner side panel (inside controller, behind front panel). Remove the backing from the tape on the back of the Receiver Card and firmly press the Card onto the spot you just cleaned. (Not illustrated here).
- Step 4: Connect the interface cable (with white connector) from the Card into the six pin molex connector on the back right-hand side of controller face (not illustrated here).
- Step 5: Connect the antenna to the BNC fitting on the Receiver Card or connect the external mount antenna with coax cable for max. range.
- Step 6: Connect all of your field common wires to the silver screw terminal on the card, then connect the black wire on the Card to a "valve common" terminal on the controller.
- Step 7: Re-install the controller face plate.
- Step 8: Re-apply power and check the remote for operation.

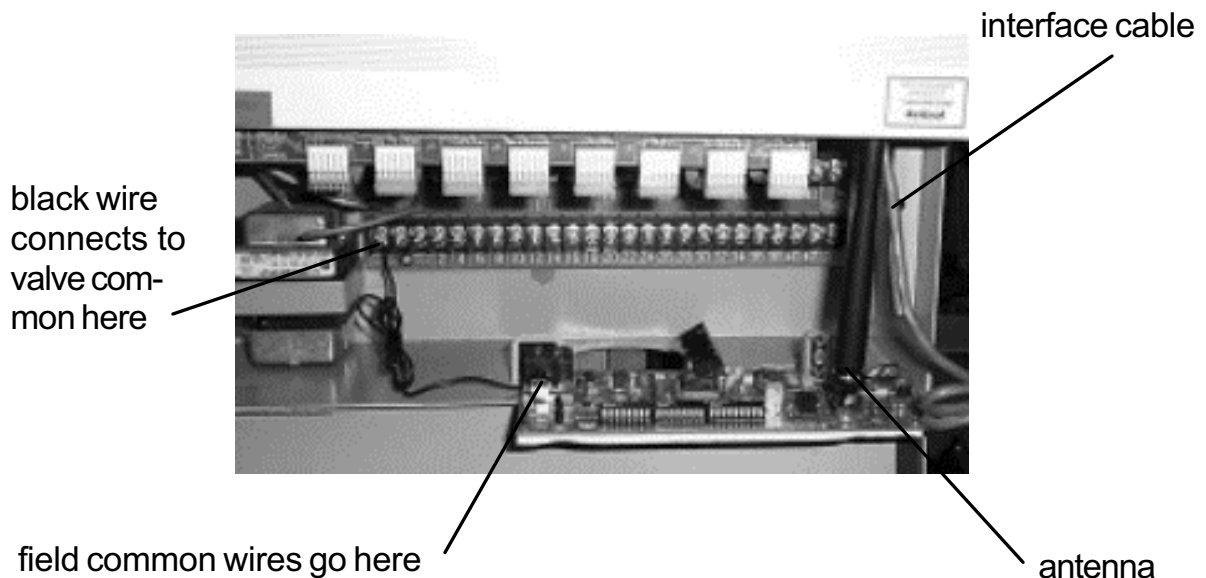

# Receiver Cards for the HIT<sup>®</sup> Logic 2 and Hit<sup>®</sup> Logic 3 Controller

## Installation Instructions:

- Step 1: **Remove power from controller first!**
- Step 2: Remove the controller's lower faceplate by removing the screws on each side.
- Step 3: Clean lower right, inner side panel (inside controller, behind front panel). Install the Receiver Card by pressing it onto the spot you just cleaned. The Card comes with the double-sided tape on the back (see picture below).
- Step 4: Connect the interface cable (with white molex connector) from the Card into the six pin interface socket on the controller labeled "**RF INTERFACE**" (see picture below).
- Step 5: Connect the antenna to the BNC fitting located on the Receiver Card to have your antenna located inside the controller **or** connect the threaded *external* mount antenna with coax cable for max. range. The holes for the "Side-Mount" antenna mount are pre-drilled on the right-hand side of the controller.
- Step 6: Re-install the controller faceplate and re-apply power.

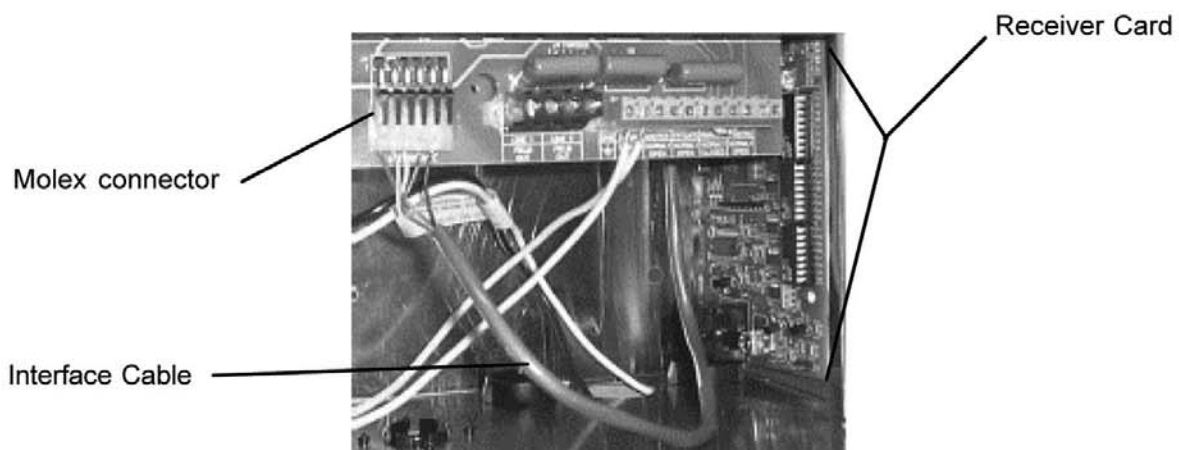

# Installing The Universal Receiver

## Connecting the TRC Commander Receiver

The TRC Commander works with any 24 VAC solenoid valve sprinkler system. The TRC Commander Receiver connects to individual valves at the controller's terminal strip or directly to the valve wires at the controller, and bypasses the controller's functions by directly activating the valves. Once the connector is installed, simply plug the Receiver into the black receptacle.

For locations where minimal operating range is needed, connect the 8" whip antenna directly to the top of the Receiver. For locations where more range is needed, use the magnetic base antenna and the included tuned antenna with threaded base. (Other antenna options are available). **For maximum performance, all antennas should be mounted far away from power transformers, electric motors, V.F.D.'s and overhead powerlines.** This type of equipment causes interference.

### **WARNING!**

**Never connect directly to 110 VAC. Damage to the receiver will occur, may be a fire hazard and will void warranty.**

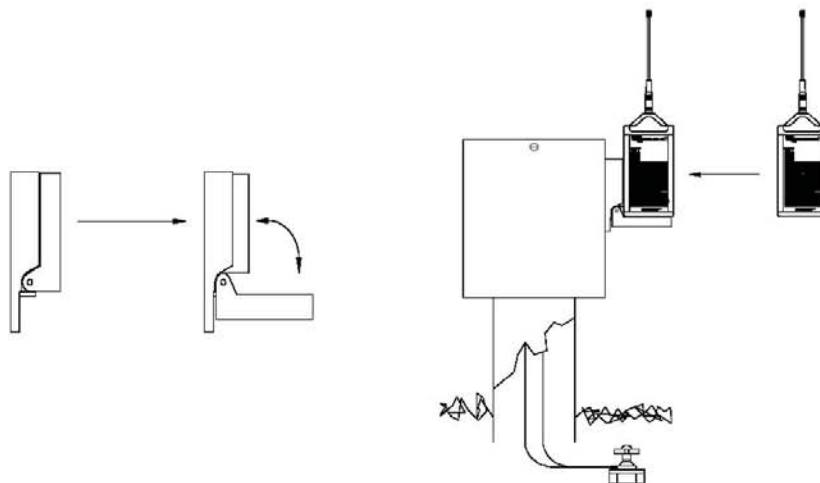

## Wiring Your PCC

Instructions also provided with PCC.

### Warning

**Do not have the Receiver plugged into connector cable while installing connector or damage may occur.  
Do not have 24VAC transformer plugged into Receiver with the connector when the connector has 24VAC from the controller!**

- Step 1: Use (figure 4 from the pamphlet with your PCC) as a pattern to locate the mounting holes to be drilled through the controller.
- Step 2: Peel off sticker and attach gasket on back of housing.
- Step 3: Peel off sticker and attach gasket to inside door. Make sure gasket is snug against side walls for maximum seal.
- Step 4: Locate 1" socket head cap screw and insert through hole on door. Slip on retainer ring approximately 3/16" from threaded end of cap screw.
- Step 5: Mount housing to controller using two 6-32 x 3/4" machine screws, two flat washers, two lock washers, and two hex nuts.
- Step 6: Attach D-Sub connector to the inside housing with two 4-40 x 9/16" machine screws. Do so by first inserting the end of wires through the 1/2" hole in the sprinkler controller. Attach connector with the longer row of pins to the left. Hold connector to highest position while tightening. Follow wiring code for connecting cables.

# Direct Controller Interface Cable

For the Irritrol MC<sup>®</sup>, Dial and Superior<sup>®</sup>

## To connect the DCI-1 Cable:

Remove the faceplate from the controller. Hook the molex receptacle directly to the 6 pins on the circuit board of controller. Do not force it in--it should fit only one way. Punch knockout hole from the bottom of the controller. Position circular end of DCI-1 cable through knockout hole and attach with screws. This connector should remain with controller. Replace controller faceplate.

## To connect the DCI-2 Cable:

### WARNING

**TRC COMMANDER RECEIVER MUST BE CONNECTED TO 37-PIN CLAMSHELL BEFORE CONNECTING DCI-2 CABLE TO CONTROLLER.**

First connect the 37-pin clamshell directly to the TRC Commander Receiver. To operate the Receiver, attach the DCI-2 circular plug to the DCI-1 connector at the controller knockout location. Align pins and twist connector on with a clockwise motion. Do not force it in--it should fit only one way. This cable is removable and allows portable hookup at each controller.



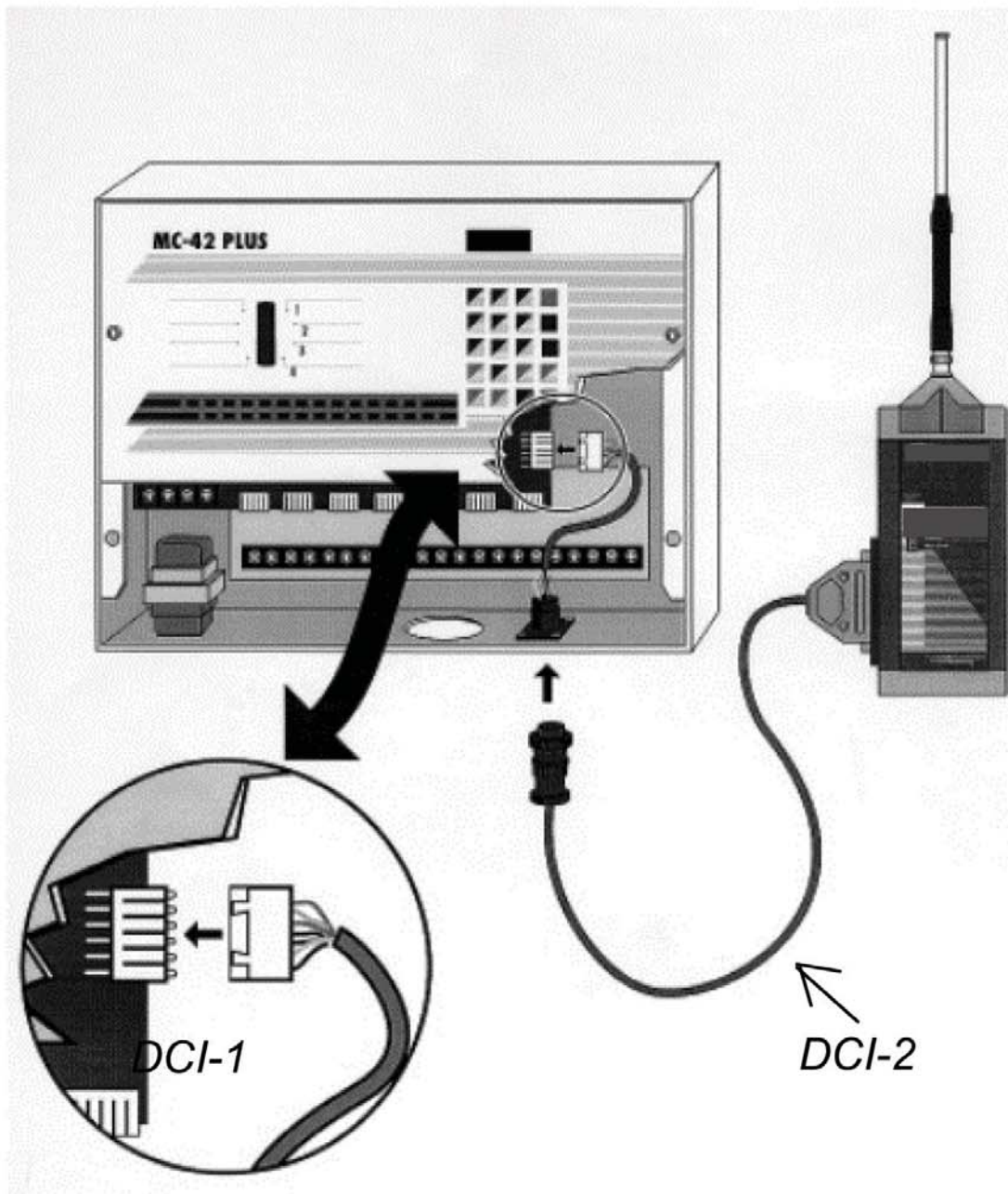

### **To disconnect the DCI-2 Cable:**

**NOTE: TRC COMMANDER RECEIVER MUST BE CONNECTED TO 37-PIN CLAMSHELL BEFORE DISCONNECTING DCI-2 CABLE FROM CONTROLLER.** To disconnect the DCI-2 cable from the controller, twist the circular plug in a counter-clockwise motion and remove from the DCI-1 cable. Remove the 37-pin clamshell from TRC Commander Receiver and store the cable in carrying case when not in use. **Extreme care should be taken with the DCI-2 cable to safeguard the integrity of its circuitry.**

# Trouble Shooting Chart

Use the following chart to determine if your problem can be corrected in the field. If you have a problem that cannot be fixed in the field:

- Call the toll free TRC Irrigation Remotes Customer Service number **(800) 275-8558** and
- You must obtain a Return Material Authorization **RMA #** prior to sending any unit in for repair.

## Fault Indication

## Correction

---

**A squawk from the transmitter.**

**An improper key sequence has** been entered and confused microprocessor. Press "0" then "Valve Off" and then continue with a proper key sequence.

**Rapid beeps** from transmitter or no sound.

An audible rapid sequence of beeps after transmission indicates low battery power. **Change the battery. (Must be alkaline!)**

Receiver "**Power On**" indicator does not come on.

Check the 24VAC pins on the controller connector with a volt meter to ensure that power is available.

If not, thoroughly check out the wiring.

Check the circuit breaker at your controller.

Controller's **circuit breaker fails.**

Check your controller manual for its power output capacity. If the transformer voltage output exceeds 28VAC permanent damage may occur.

## Fault Indication

## Correction

---

**Receiver fails** to respond, but the power light is on.

Check if the Receiver number was inadvertently changed. Reprogram the Transmitter codes to match the Receiver codes. (Press "1", "REC #")

Check the Group Code and Receiver Code dipswitches on the Receiver. Reprogram the Transmitter to match the Receiver codes. (See page 13).

Receiver's "Valve On" indicator lights during initial test, but **no valve or wrong valve comes on.**

Use an ohmmeter to check that your connector's wire assignment matches your controller's valve assignment.

**Rain Bird's RC series** controller advances to the first station with remote operation.

Install the RC Series Controller Isolation Relay (Part #02002).

**Receiver turns off** when one station is activated.

Check solenoid. Current drain is more than 3 amps and is tripping the resetting fuse.

**Short Range**

Ensure that the antennas are firmly attached to the Receiver and Transmitter.

Ensure that the antenna is clear from obstructions. The three feet immediately surrounding the antenna are the most crucial and should be kept clear of obstructions, power lines, or electrical conduits, electric motors etc.

Keep the antenna as high as possible on the controller and avoid situations where the antenna can be shadowed by buildings or large metal structures.

Ensure that the Receiver's antenna is as far away from electric motors, V.F.D.'s and overhead powerlines as this type of equipment causes interference.

## 32 Station Connector Wiring Color Codes

Valve	Wire Color	Valve	Wire Color
1	Black	19	Green w/ black and white stripe
2	White	20	Orange w/ black and white stripe
3	Red	21	Blue w/ black and white stripe
4	Green	22	Black w/ red and green stripe
5	Orange	23	White w/ red and green stripe
6	Blue	24	Red w/ black and green stripe
7	White w/ black stripe	25	Green w/ black and orange stripe
8	Red w/ black stripe	26	Orange w/ black and green stripe
9	Green w/ black stripe	27	Blue w/ white and orange stripe
10	orange w/ black stripe	28	Black w/ white and orange stripe
11	Blue w/ black stripe	29	White w/ red and orange stripe
12	Black w/ white stripe	30	Orange w/ white and blue stripe
13	Blue w/ red stripe	31	White w/ red and blue stripe
14	Red w/ green stripe	32	Black w/ white and green stripe
15	Orange w/ green stripe		
16	Black w/ white and red stripe	Com	Orange w/ red stripe
17	White w/ black and red stripe	M.V.	Green w/ white stripe
18	Red w/ black and white stripe	24 V	Blue w/ white stripe



1(800) 275-8558  
[www.irrigationremotes.com](http://www.irrigationremotes.com)