

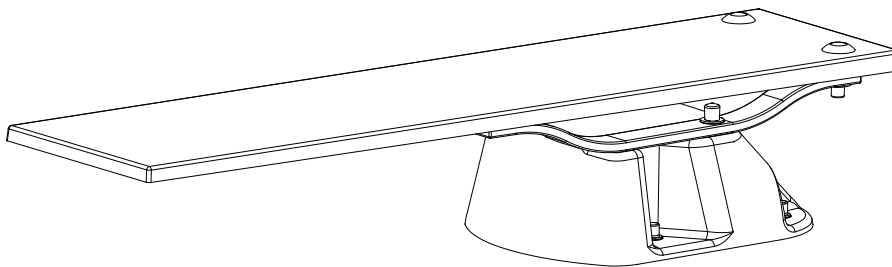

SALT POOL JUMP SYSTEM

ASSEMBLY AND INSTALLATION INSTRUCTIONS



****PROFESSIONAL INSTALLATION RECOMMENDED****

WARNING

POOL WATER ENVELOPE DIMENSIONS MUST MEET OR EXCEED ANSI/APSP/ICC-5 2011 STANDARDS FOR THIS STAND/BOARD. USE ONLY WITH A COMPATIBLE S.R. SMITH DIVING BOARD/STAND. S.R. SMITH DIVING BOARDS AND RELATED EQUIPMENT ARE FOR IN-GROUND POOLS ONLY. DO NOT USE WITH OTHER POOLS, DOCKS, ETC.

USE WITH AN IMPROPERLY-SIZED POOL, INCOMPATIBLE STAND/BOARD, OR IMPROPER INSTALLATION MAY RESULT IN DEATH OR SERIOUS INJURY.



ATTENTION!
THESE INSTRUCTIONS MUST REMAIN WITH PLATFORM OWNER

SALT POOL JUMP SYSTEM:

For 6' and 8' Diving Boards

TABLE OF CONTENTS

RESIDENTIAL PLACEMENT AND PARTS LIST 2
INSTALLATION INSTRUCTIONS 2
ARTICLE 5 – POOL DIMENSIONS AND TOLERANCES
EXTRACTED FROM THE ANSI/APSP/ICC-5 2011
AMERICAN NATIONAL STANDARD FOR RESIDENTIAL INGROUND SWIMMING POOLSB

REGISTER YOUR S.R. SMITH PRODUCT AT

www.srsmith.com/en/customer-service/product-registration

AND VISIT

www.srsmith.com/saltfriendly

TO SEE THE COMPLETE LINE OF SALT FRIENDLY POOL DECK EQUIPMENT:

- SLIDES

- GAMES

- AND MORE!



Visit srsmith.com for information on the complete line of S.R.Smith pool products.

SRS AUSTRALIA, PTY LTD
12 Enterprise St
Richlands QLD 4077
Australia
Phone 07 3812 2283 • Fax 07 3812 1187
www.srsmith.com/au

S.R. SMITH, LLC
CORPORATE HEADQUARTERS
P.O. Box 400 • 1017 S.W. Berg Parkway
Canby, Oregon 97013
USA
Phone (503) 266 2231 • Fax (503) 266 4334
www.srsmith.com

RESIDENTIAL PLACEMENT AND PARTS LIST

FIGURE A

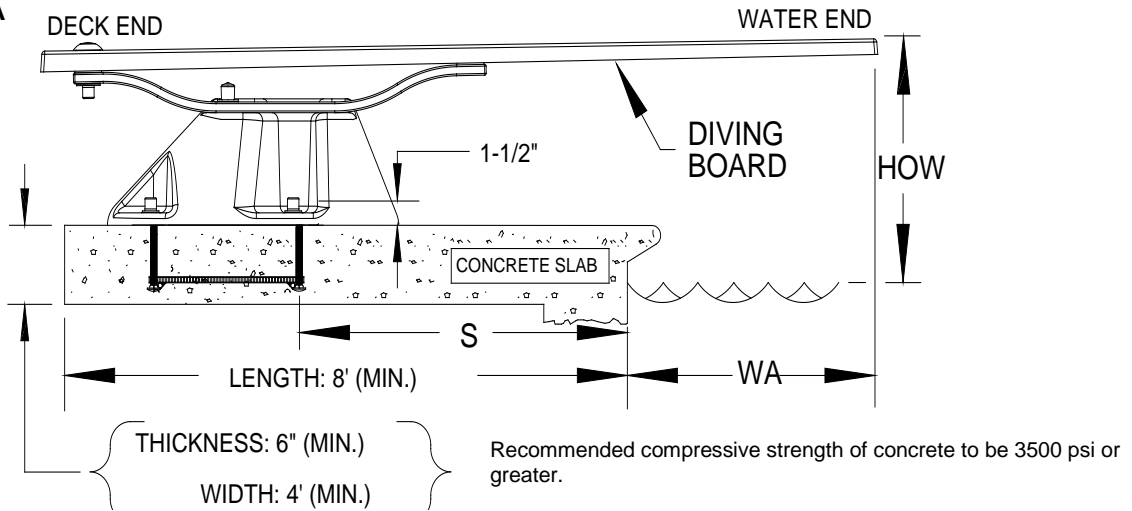

TIGHTENING SCHEDULE

1. SECURE STAND TO JIG WITH ANCHOR HEX NUTS, TIGHTEN UNTIL LOCK WASHERS ARE COMPRESSED.
2. SECURE SPRING TO STAND WITH MOUNTING HEX NUTS, TIGHTEN UNTIL LOCK WASHERS ARE COMPRESSED.
3. SECURE BOARD TO STAND WITH MOUNTING HEX NUTS, TIGHTEN UNTIL LOCK WASHERS ARE COMPRESSED.

FIGURE B

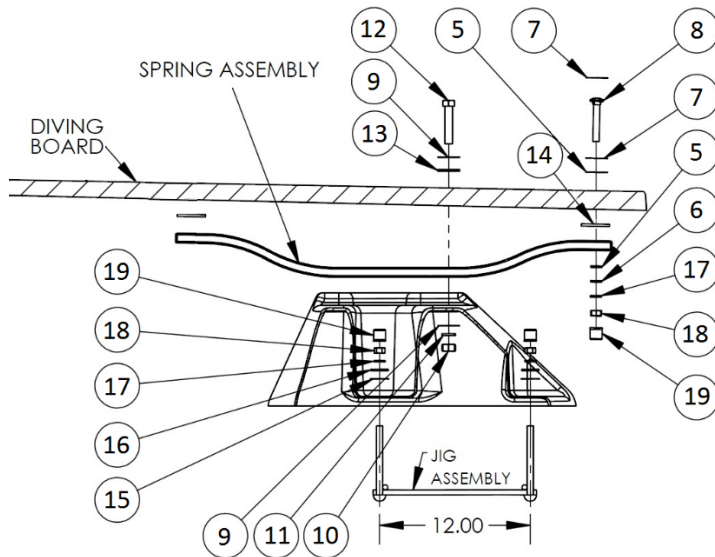

RESIDENTIAL BOARD MOUNTING KIT (67-209-911-SS)

1. 1/2" X 4-1/2" CARRIAGE BOLT S/S (2 EA) **NOTE: THE SALT BASE ASSEMBLY REQUIRES 1/2" X 3-1/2" CARRIAGE BOLTS FOUND IN KIT # 69-209-125. THE 1/2" X 4-1/2" ARE NOT USED IN THIS ASSEMBLY.**
2. 1/2" LOCK WASHER S/S (2 EA.)
3. 1/2" HEX NUT S/S (2 EA.)
4. 1/2" PLASTIC NUT CAP (2 EA.)
5. 1/2" X 2" BLACK RUBBER MOUNTING WASHER (4 EA.)
6. 1/2 X 2" FLAT WASHER S/S (2 EA.)
7. WHITE PLASTIC RECESSED MOUNTING WASHER ASSY' (2 EA.)

SALT POOL SPRING BOLT KIT (69-209-125)

8. 1/2" X 3-1/2" CARRIAGE BOLT S/S (2 EA)
9. 5/8" X 1-3/4" FLAT WASHER S/S (4 EA.)
10. 5/8" HEX NUT S/S (2 EA.)
11. 5/8" LOCK WASHER S/S (2 EA.)
12. 5/8" X 3" HEX HEAD BOLT S/S (2 EA.)
13. 5/8" X 1-3/4" NYLON PROTECTIVE WASHER (2 EA.)
14. 2-1/4" SQUARE RUBBER SPRING PAD (2 EA)

SALT POOL STAND HARDWARE KIT (69-209-126)

FOR TAUPE STAND USE 69-209-126-TP

FOR PEWTER GRAY STAND USE 69-209-126-PG

15. 1/2" X 1-1/2" ROUND NYLON WASHER (4 EA.)
16. 1/2" X 1-3/8" FLAT WASHER S/S (4 EA.)
17. 1/2" LOCK WASHER S/S (4 EA.)
18. 1/2" HEX NUT S/S (4 EA.)
19. 1/2" PLASTIC NUT CAP (4 EA.)

INSTALLATION INSTRUCTIONS

**TABLE 1 – SALT POOL JUMP SYSTEM
INSTALLATION CHART**
Refer to FIGURE A

Model	Diving Board Length	Distance For Setting Front Bolt of Jig From Water's Edge "S"	Pool Type (ANSI/APSP/ICC-5 2011)	Min. Overhang ± 3" (76mm) "WA"	Max. Height of Board Above Water "HOW"
Frontier III or	6'	32"	I	18"	20"
	6'	32"	II	18"	20"
	6'	26"	III	24"	26"
	8'	45"	III	24"	26"
Glas-Hide	6'	20"	IV	30"	30"
	8'	39"	IV	30"	30"
	6'	14"	V	36"	40"
	8'	33"	V	36"	40"

IMPORTANT: The distance for setting the front bolt of the jig "S" from the water's edge is valid only if the minimum water depth is maintained at the tip of the board noted at point A in ANSI/APSP/ICC-5 2011, Figure 3 and Table 1. If minimum water depth is not maintained the distance "S" must be adjusted accordingly.

*WA DIMENSION IS VALID ONLY IN CONJUNCTION WITH MIN. DEPTH AT POINT A (SEE ANSI/APSP/ICC-5 2011 FIGURE 3 AND TABLE 1) FOR POOL TYPE.

**When coping is used do not set front bolt of jig closer than 3" (76 mm) from the back edge of coping.

BE SURE CONCRETE DECK SURROUNDING ANCHOR JIG COMPLIES WITH MINIMUM DIMENSIONS IN FIGURE A.

****Professional installation recommended****

****Improper installation voids S.R. Smith's Limited Product Warranty****

1. Verify that the pool water envelope dimensions meet or exceed ANSI/APSP/ICC-5 2011 standards for this board and stand. Excerpts from the applicable ANSI/APSP/ICC-5 2011 standard are attached and more information on safe installation is available at www.srsmith.com. **Warning: using the diving board and stand with an improperly-sized pool may result in death or serious injury.**
2. Verify that the board is compatible with the S.R. Smith diving board stand. A matrix of compatible products is attached and available at www.srsmith.com.
3. Identify installation site. Board must be placed at deep end of pool on centerline. Set 606/608 four bolt jig in accordance with the Installation Chart above and FIGURE A, with the two "RED" capped bolts closest to the pool.

CAUTION: Before pouring concrete around jig, check the bolt pattern of jig to FIGURE B. It is possible that they may have become misaligned through shipping and handling.

4. Make sure bolts project out of the concrete 1-1/2" with ample concrete depth below jig. Refer to FIGURE A for minimum deck thickness, width and length.
5. When finishing deck surface, maintain level deck where jig bolts project out so that the stand makes uniform contact with deck surface.
6. Before mounting stand, chisel away any excess concrete that may have built up around jig bolts and remove the red and yellow bolt caps.
7. Place springs over stand and secure according to FIGURE B. The spring cannot be secured to the stand after the stand has been assembled to the jig. Tighten MOUNTING hex nuts. Use TIGHTENING SCHEDULE on page 3 when tightening all MOUNTING and ANCHOR hex nuts.
8. Place stand over jig bolts and secure according to FIGURE B. Tighten ANCHOR hex nuts.
9. With the 6' or 8' SALT POOL JUMP SYSTEM STAND properly secured, install diving board to spring assembly according to FIGURE B and tighten MOUNTING hex nuts.
10. The top surface of the diving board from the deck end to the tip end shall be level or have an upward slope of 5/8" per foot (16 mm: 305mm) maximum. Elevation difference shall not exceed 6 inches (152mm) from the deck end to the tip of the board. There shall be no downward slope towards the water. The slope shall be measured using a level as shown in FIGURE D.

NOTICE:

S.R. SMITH CANNOT GUARANTEE
CUSTOMER'S CONCRETE STRENGTH OR
THICKNESS

IMPORTANT NOTICE:

IT IS NECESSARY TO USE AN ANTI-SEIZE
COMPOUND ON ALL STAINLESS STEEL
HARDWARE. FAILURE TO USE ANTI-SEIZE
COMPOUND MAY RESULT IN GALLING AND
SEIZING OF THE HARDWARE.

**ONLY ONE PERSON ON DIVING PLATFORM AT A TIME
WITH A MAXIMUM WEIGHT OF 250 LBS (113kg)**

TABLE 2 – S.R. SMITH RESIDENTIAL POOL SPECIFICATIONS

FROM IMPORTANT: Maximum diving board length, maximum height over water at point A, and minimum cross section dimensions at point A and B shall be in accordance with Table 2 and FIGURE C.

Pool Type	MAX. DIVING BOARD LENGTH	MAX. HEIGHT OVER WATER AT POINT A	CROSS SECTIONAL DIMENSIONS AT POINT A		CROSS SECTIONAL DIMENSIONS AT POINT B					
	DBL**	HOW**	F	G	H	J	K	L	M	N
0	DIVING EQUIPMENT IS PROHIBITED									
I	6' (1.83m) DB/ 6' (1.83m) JB	20" (50.8cm)	2'-9" (83.8cm)	5'-0" (1.52m)	4'-0" (1.22m)	7'-2 1/2" (2.20m)	7'-6" (2.29m)	6'-0" (1.83m)	3'-9" (1.14m)	2'-1 1/2" (64.8cm)
II	8' (2.44m) DB/ 6' (1.83m) JB	20" (50.8cm)	2'-9" (83.8cm)	3'-10" (1.17m)	4'-2" (1.27m)	7'-2 1/2" (2.20m)	7'-6" (2.29m)	6'-8" (2.03m)	3'-9" (1.14m)	2'-1 1/2" (64.8cm)
III	10' (3.05m) DB/ 8' (2.44m) JB	26" (66cm)	2'-9" (83.8cm)	4'-4 3/4" (1.34m)	4'-4 1/2" (1.33m)	7'-5 1/2" (2.27m)	8'-0" (2.44m)	6'-7" (2.01m)	3'-11 1/2" (1.21m)	1'-7 1/2" (49.5cm)
IV	10' (3.05m) DB/ 8' (2.44m) JB	30" (76.2cm)	2'-9" (83.8cm)	5'-10 1/2" (1.79m)	3'-10" (1.17m)	7'-8" (2.34m)	8'-6" (2.59m)	8'-3" (2.51m)	5'-7" (1.70m)	2'-7" (78.7cm)
V	12' (3.66m) DB/ 8' (2.44m) JB	40" (1m)	2'-9" (83.8cm)	6'-2" (1.88m)	3'-11 1/2" (1.21m)	7'-9 1/2" (2.37m)	9'-0" (2.74m)	8'-2 1/2" (2.50m)	5'-9" (1.75m)	2'-1" (63.5cm)

NOTES:

- ** ABBREVIATIONS: DBL = Diving Board Length, DB = Diving Board, JB = Jump Board, HOW = Height Over Water.
- IMPORTANT: The walls of a Type I Pool, when defining the Maximum Diving Water Envelope shall be plumb.
- All dimensions are minimum, except where noted as maximum.
- One half (1/2) the width shown at each point shall be available on each side of the diving equipment centerline.
- Minimum water depth under tip of diving board (Point A) is important to maintain.

FIGURE C – Minimum Cross Sections (Refer to ANSI/APSP/ICC-5 2011 Figure 3 on Page B)

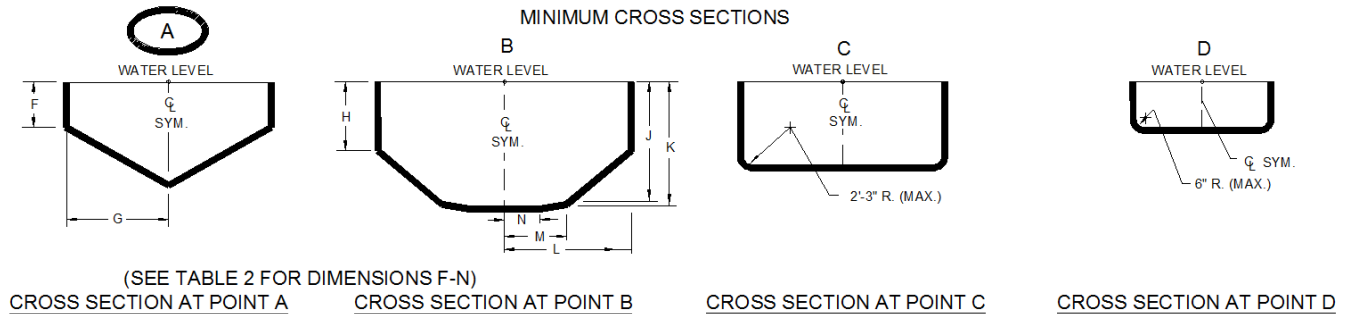

FIGURE D

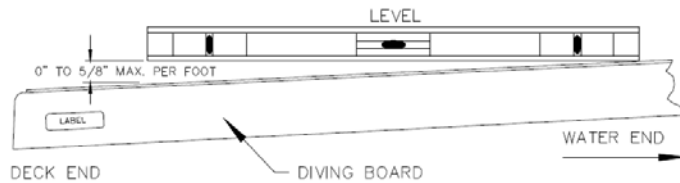

TABLE 3 – Minimum Headroom Requirements

Minimum unobstructed headroom from the top of the manufactured diving equipment is specified below.

Pool Type	Minimum Headroom Above Diving Surface
I	12 feet (3.7 m)
II	12 feet (3.7 m)
III	13 feet (4 m)
IV	13 feet (4 m)
V	14 feet (4.3 m)

ARTICLE 5 – POOL DIMENSIONS AND TOLERANCES
EXTRACTED FROM THE ANSI/APSP/ICC-5 2011
AMERICAN NATIONAL STANDARD FOR RESIDENTIAL INGROUND SWIMMING POOLS

5 Pool Dimensions and Tolerances

5.1 General requirements. Design dimensions shall comply with the specifications in this standard. The pool shall be constructed to these design dimensions within the tolerances listed in 5.1.1.

5.1.1 Construction tolerances. There shall be construction tolerances allowed on dimensional designs. The length, width, and depth shall be limited to a tolerance of plus or minus 3 in. (± 76 mm). All other dimensions shall be limited to a tolerance of ± 2 in. (± 51 mm), unless otherwise specified.

NOTE: Negative construction tolerances shall not be applied to the shallow area dimensions of the Minimum Diving Envelope given in Table 1, p. 4.

Figure 1 Maximum allowable wall slope

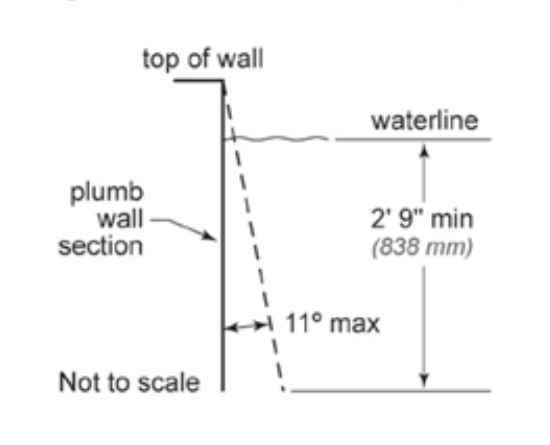
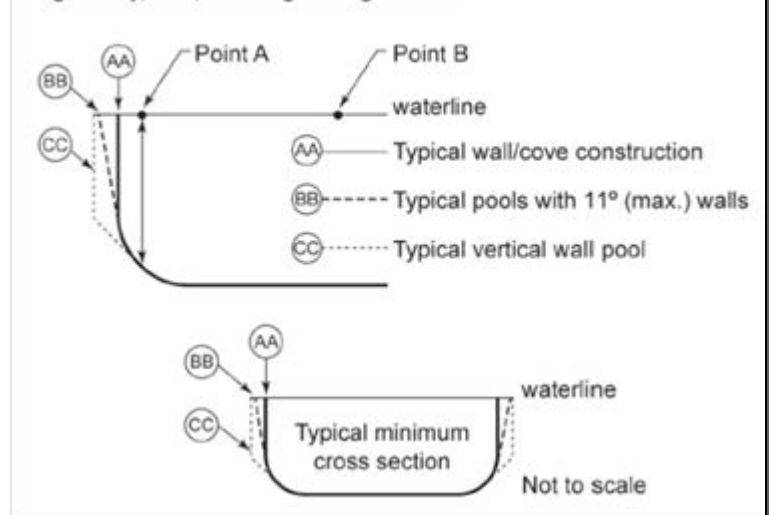

Figure 2 Typical pool design configurations



5.2 Perimeter shape. No limits are specified for shapes of pools. Consideration shall be given to circulation and safety to the user.

5.3 Walls—Requirements

5.3.1 Walls in the shallow area and deep area of the pool shall not slope greater than 11° (5:1 slope ratio) to a transition point of the floor (see Figure 1). The transition to the bottom of the pool between points D and E (see Figure 3, p. 5) shall not be less than 2 ft 3 in. (686 mm) below the waterline.

5.3.2 As shown in Figure 2, at the depths of (A) and (B), the walls are permitted to continue to join the floor.

Figure 3 Minimum diving water envelope

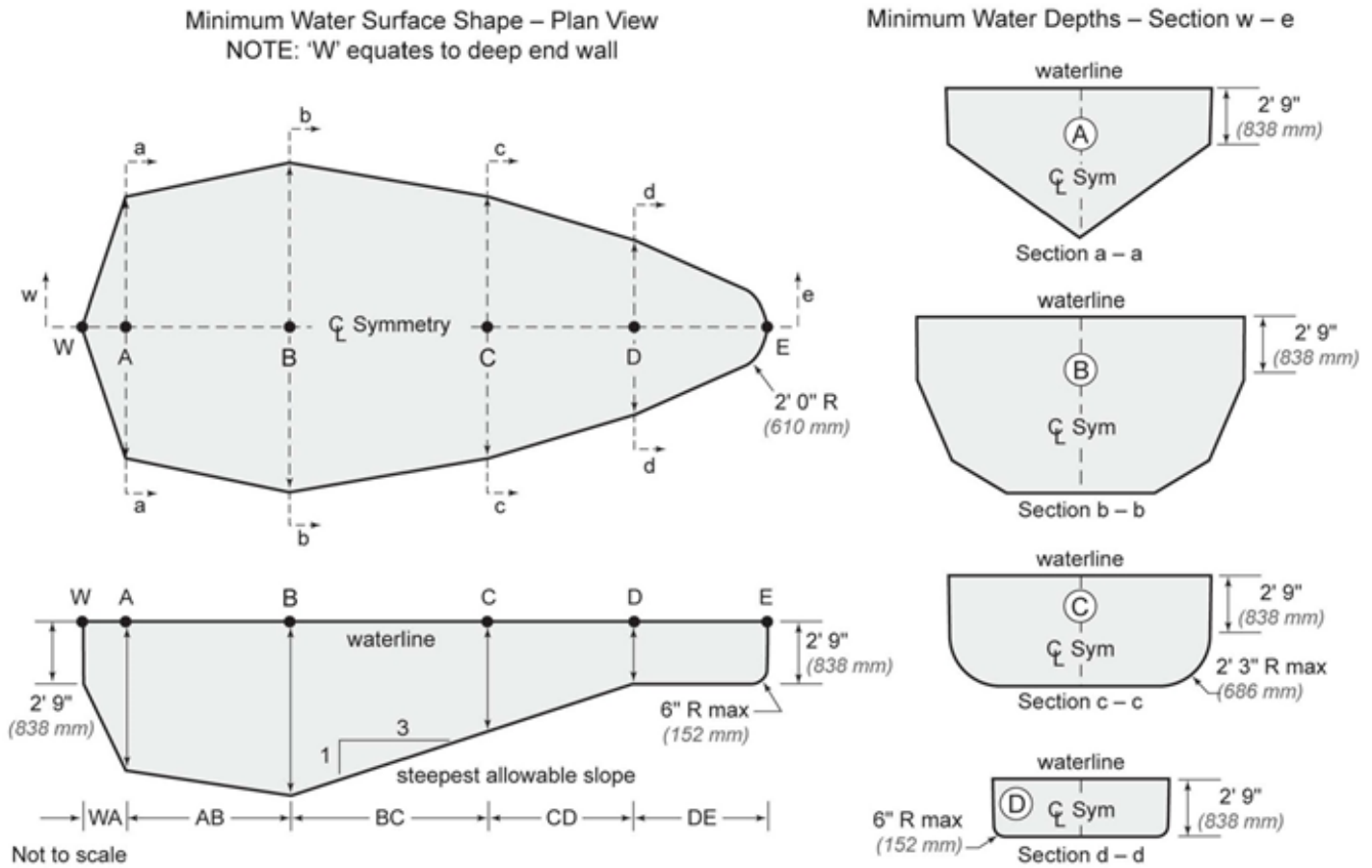

Table 1. Minimum diving water envelope for swimming pools designated types I-V

Pool Types	Minimum Depths at Point				Minimum Widths at Point				Minimum Lengths between Points					
	A	B	C	D	A	B	C	D	WA	AB	BC	CD	DE	WE
0	Manufactured diving equipment is prohibited													
1	6' 0" (1.82 m)	7' 6" (2.29 m)	5' 0" (1.52 m)	2' 9" (838 mm)	10' 0" (3.05 m)	12' 0" (3.66 m)	10' 0" (3.05 m)	8' 0" (2.44 m)	1' 6" (457 mm)	7' 0" (2.13 m)	7' 6" (2.29 m)	Varies	6' 0" (1.82 m)	28' 9" (8.76 m)
2	6' 0" (1.82 m)	7' 6" (2.29 m)	5' 0" (1.52 m)	2' 9" (838 mm)	12' 0" (3.66 m)	15' 0" (4.57 m)	12' 0" (3.66 m)	8' 0" (2.44 m)	1' 6" (457 mm)	7' 0" (2.13 m)	7' 6" (2.29 m)	Varies	6' 0" (1.82 m)	28' 9" (8.76 m)
3	6' 10" (2.08 m)	8' 0" (2.44 m)	5' 0" (1.52 m)	2' 9" (838 mm)	12' 0" (3.66 m)	15' 0" (4.57 m)	12' 0" (3.66 m)	8' 0" (2.44 m)	2' 0" (610 mm)	7' 6" (2.29 m)	9' 0" (2.74 m)	Varies	6' 0" (1.82 m)	31' 3" (9.53 m)
4	7' 8" (2.34 m)	8' 6" (2.59 m)	5' 0" (1.52 m)	2' 9" (838 mm)	15' 0" (4.57 m)	18' 0" (5.49 m)	15' 0" (4.57 m)	9' 0" (2.74 m)	2' 6" (762 mm)	8' 0" (2.44 m)	10' 6" (3.20 m)	Varies	6' 0" (1.82 m)	33' 9" (10.3 m)
5	8' 6" (2.59 m)	9' 0" (2.74 m)	5' 0" (1.52 m)	2' 9" (838 mm)	15' 0" (4.57 m)	18' 0" (5.49 m)	15' 0" (4.57 m)	9' 0" (2.74 m)	3' 0" (914 mm)	9' 0" (2.74 m)	12' 0" (3.66 m)	Varies	6' 0" (1.82 m)	36' 9" (11.2 m)

NOTES

1. Minimum length between points CD may vary based upon water depth at point D and the slope between points C and D.
2. Drawings are not to scale.
3. Negative construction tolerances (see para. 5.1.1) shall not be applied to any of the dimensions shown in the Minimum Water Envelopes given in Table 1.
4. Pool types designate minimum water envelope sizes as specified by the diving board manufacturers.

Figure 4 Offset ledges

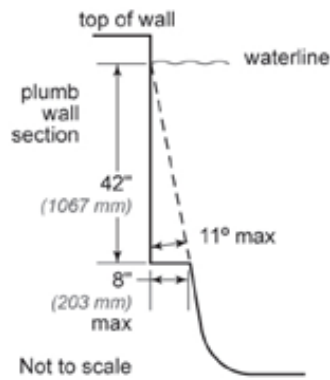
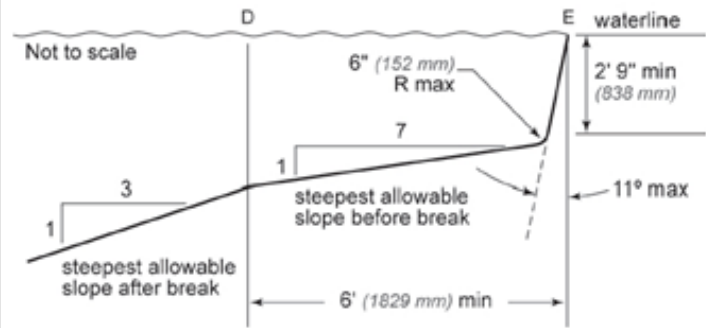

Figure 5 Shallow end depths



5.4 Offset Ledges

5.4.1 Offset ledges shall be a maximum of 8 in. (203 mm) wide.

5.4.1.1 Offset ledges located less than 42 in. (1.07 m) below waterline shall be proportionately less than 8 in. (203 mm) wide and fall within 11° from plumb, measured from the top of the waterline (see Figure 4).

5.5 Floor slopes. Floor slopes shall be reasonably uniform and comply with paras. 5.5.1 through 5.5.3.

5.5.1 The slope of the floor from the shallow end wall towards the deep area shall not exceed a 1:7 incline to the point of the first slope change, if any (D–E) as shown in Figure 5.

5.5.2 Changes in slope between shallow and deep areas shall be at a minimum water depth of 2 ft 9 in. (838 mm) and be at least 6 ft (1.83 m) from the shallow end, except as specified in para. 6.3.

5.5.3 The slope of the floor shall not exceed a 1:3 incline under the lengths (B–D) of the Diving Envelope (see Figure 5).

5.6 Shallow end water depths. Water depth in the shallow area shall be a minimum of 2 ft 9 in. (838 mm), except for those locations specified in para. 6.3 “Shallow End Detail for Beach and Sloping Entries.”

5.7 Manufactured diving equipment for in-ground swimming pools (diving board/stand combination, manufactured platform, or field fabricated)

5.7.1 When manufactured or field fabricated diving equipment is installed, it shall conform to the specifications set forth in paras. 5.7–5.9. It shall be located in the deep area of the pool to provide the minimum dimensions as shown in para. 5.8, and shall be installed in accordance with manufacturer’s instructions.

5.7.1.1 Manufactured or field fabricated diving equipment shall be located directly above Point A. Diving equipment shall not be installed on Type O pools (see Table 1).

5.7.1.2 Maximum elevation of a diving board above the water shall be in accordance with manufacturer’s installation instructions. Raised decking may be installed around the diving board up to level with the top of the board.

5.7.2 Manufactured diving equipment installation and use instructions shall be provided by the diving equipment manufacturer and shall specify the minimum water dimensions required for each diving board and diving stand combination. They shall refer to the diving envelope type of their choice by dimensionally relating their products to Point A on the diving envelopes as shown in Figure 3, Table 1, and paras. 5.8.1–5.8.3

5.7.2.2 Diving equipment shall be permanently labeled and affixed to the diving equipment or jump boards and include, but not be limited to the following:

- manufacturer’s diving equipment name and address
- date of manufacture
- minimum diving envelope
- maximum weight limitations.

5.7.2.3 Diving equipment shall have slip-resisting tread surfaces.

5.8 Figure 3 diagrams show dimension points referred to in Table 1.

5.8.1 Point A: Point A is the point from which all other forward dimensions of width, length, and depth are then established for the Minimum Diving Water Envelope. If the tip of the diving board or diving platform overhang is located at a distance of WA or greater from the deep end wall and the water depth at that location is equal to or greater than the water depth requirement at Point A (see Table 1), then the point on the water surface directly below the center of the tip of the diving board or diving platform shall be identified as Point A.

5.8.1.2 Location of Point A: The minimum Diving Water Envelope dimensions for pools with manufactured diving equipment shall be taken from Point A as shown in Figure 3. Point A shall be defined as the point on the water surface where the water depth is required at Point A and is provided at a distance of WA as shown in Table 1 from the deep end

wall. The center of the tip of the diving board, platforms, manufactured or field fabricated shall be located directly above Point A.
5.8.1.3 Point A as shown in Figure 3 and Table 1 shall be the reference point of origin for all dimensions defining the minimum diving envelope.

5.8.2 Type O pools (where diving is prohibited) shall not be limited in width, length, or water depth except as specifically provided for in this standard.

Pool Type I 42 in. (1.07 m)

Pool Type II 42 in. (1.07 m)

Pool Type III 50 in. (1.27 m)

Pool Type IV 60 in. (1.52 m)

Pool Type V 69 in. (1.75 m).

5.8.3 Location of equipment and pool features in the minimum diving envelope. If the pool is designed for use with diving equipment, all steps, pool stairs, ladders, underwater benches, offset ledges special features and other accessory items or any parts thereof, these features shall be located outside the Minimum Diving Envelope (see Figure 6).

5.9 Stationary diving platform(s) and diving rock(s).

Stationary diving platform(s) and diving rock(s) built on site field fabricated shall be allowed to be flush with the wall and located in the diving area of the pool. Point A shall be in front of the wall at the platform or diving rock centerline. Diving rocks or platforms are prohibited on Pool Type O.

5.10 Stationary diving platform(s) and diving rock(s)

5.10.1 Stationary diving platform(s) and diving rock(s) shall not be permitted on Pool Type O.

5.10.2 The maximum height of the stationary diving platform or diving rock above the waterline shall be as follows:

Pool Type I 42 in. (1.07 m)

Pool Type II 42 in. (1.07 m)

Pool Type III 50 in. (1.27 m)

Pool Type IV 60 in. (1.52 m)

Pool Type V 69 in. (1.75 m).

5.10.3 The diving equipment manufacturer shall specify minimum headroom above water.

5.11 Swimming pool slides

5.11.1 Slides, where installed, shall be installed in accordance with the manufacturer's specifications and comply with the U.S. Consumer Product Safety Commission (CPSC) Standard for Swimming Pool Slides as published in the Code of Federal Regulations, 16 CFR Ch. II, Part 1207.

5.11.2 Slides constructed on-site are not covered by this standard.

NOTE: For consumer safety information, warnings, and education programs, see Appendices F, G, and H.

Figure 6 Top view examples of accessory equipment and pool features prohibited in the minimum diving envelope

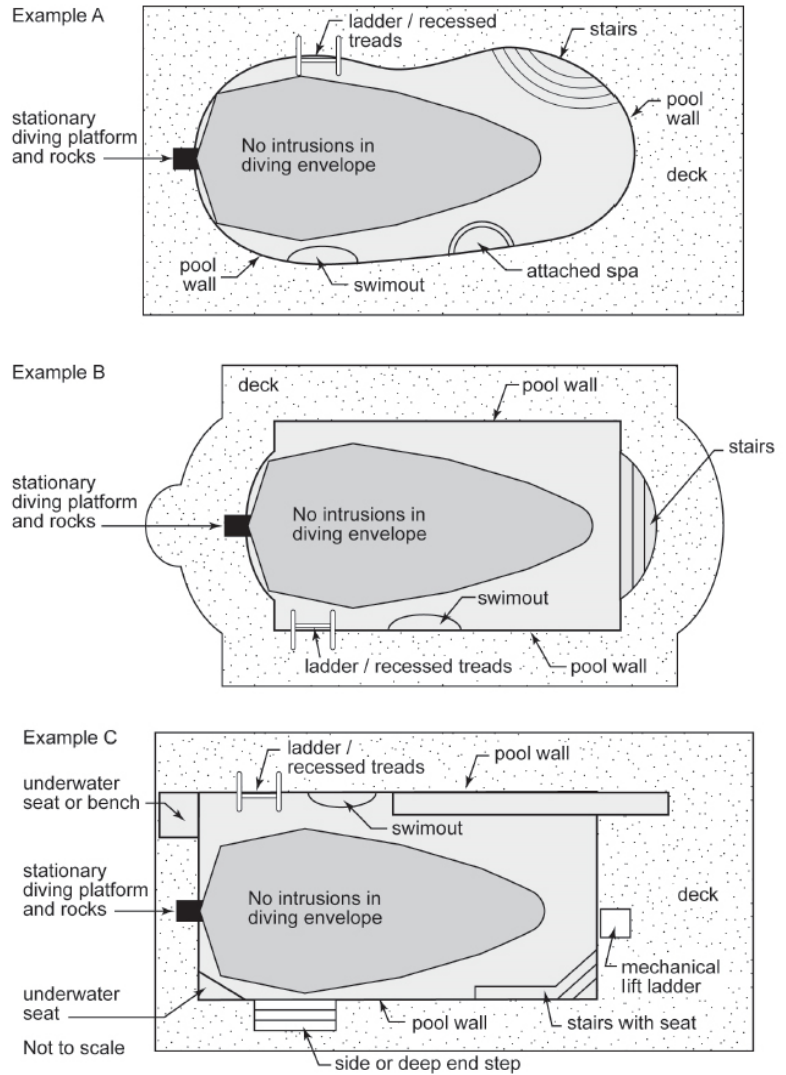

Appendix F Recommendations to Warn Against Shallow Water Diving

This appendix is not part of the American National Standard ANSI/APSP/ICC-5 2011. It is included for information only.

Recommended methods to warn against shallow water diving may include, but not be limited to:

A. Safety Signs

It is an open question before the Human Factors Society and others whether signage is an effective means that will modify human behavior to prevent accidents.

If warning signs are used to warn against shallow water diving, the signage should be in compliance with ANSI-Z535 1998 Series of standards for safety signs and colors or the latest revision.

This sign is based upon a study entitled "Design of Swimming Pool Warnings." This sign has been reviewed by the staff of the U.S. Consumer Product Safety Commission and supports its use.

B. Additional Signage Use

The ANSI-Z535 Series of Standards reflects the consensus of various experts on warning sign appearance and content. Signage, which is consistent with the ANSI-Z535 Standards, is permitted to be added to components, equipment, facilities, or installations, to provide additional information.

Manufacturers are permitted to either affix additional signage to their products or packaging, or to supply the signage with the product to be affixed at the time of installation

Appendix G Safety Considerations and Warning Recommendations

This appendix is not part of the American National Standard ANSI/APSP/ICC-5 2011. It is included for information only.

The Association of Pool & Spa Professionals (APSP) suggests that the builders/installers of swimming pools advise the initial owner/operator of a residential pool of the following:

Warning Recommendations: The APSP suggests the builder/installer advise the pool owner of the risk of drowning, especially for children under the age of five, and the risk of diving into shallow water in one or more of the following ways: verbally, through publications or signage. The following are suggested recommendations:

Lifesaving Equipment: The APSP suggests the builder/installer advise the pool owner/operator that basic lifesaving equipment including one or more of the following items should be on hand at all times:

- A light, strong, rigid pole not less than twelve feet (12', 3.7 m) long
- A minimum one fourth inch (6 mm) diameter throwing rope as long as one and one-half (1½) times the maximum width of the pool or 50 feet (15.2 m), whichever is less, which has been firmly attached to a Coast Guard-approved ring buoy having an outside diameter of approximately 15 in. (381 mm), or some other similar flotation device.

Safety Considerations for Pool Owner/Operators: For additional safety information see www.APSP.org.

This standard does not replace good judgment and personal responsibility. In permitting use of the pool by others, owners/operators must consider the skill, attitude, training, and experience of the expected user. It is the pool owner/operator's responsibility to learn, understand, and enforce these basic safety principles and rules:

- Encourage children to learn how to swim.
- Never allow diving, jumping or sliding into shallow water.
- Adequate adult supervision is required when the pool is in use.
- Adequate adult supervision is always required when children are present.
- Encourage parents to learn CPR.
- Encourage children to never swim alone.
- Keep all electrical radios, speakers and other appliances away from the swimming pool.
- Do not allow roughhousing and horseplay.
- Keep deck clean and clear of objects that may create a hazard.
- Keep all breakable objects out of the pool area.
- Alcohol consumption and pool activities do not mix. Never allow anyone to swim, dive or slide under the influence of alcohol or drugs.

Figure 8 Sign warning against shallow water diving



Do's and Don'ts for Diving into swimming pools with manufactured diving equipment, diving rocks, and stationary diving platforms:

- Do know the shape of the pool bottom and the water depth before you dive or slide headfirst.
- Do plan your path to avoid submerged obstacles, surface objects, or other swimmers.
- Do hold your head up, arms up, and steer up with your hands.
- Do practice carefully before you dive or slide.
- Do test the diving board for its spring before using.
- Do remember that when you dive down, you must steer up.
- Do dive straight ahead, not off the side of the diving board.
- Don't drink and dive.
- Don't dive or slide headfirst in the shallow part of the pool.
- Don't dive from any place that is not specifically designed for diving.
- Don't ever dive head first into shallow water (5 feet or less).
- Don't dive across the narrow part of the pool.
- Don't run and dive.
- Don't dive from any place that is not specifically designed for diving.
- Don't engage in horseplay on diving or sliding equipment.
- Don't use diving equipment as a trampoline.
- Don't do a back dive.
- Don't try fancy dives; keep the dives simple.
- Don't dive or slide headfirst at or through objects such as inner tubes.
- Don't put diving or sliding equipment on a pool that wasn't designed for it.
- Don't swim or dive alone.
- Don't dive into unfamiliar bodies of water.

Rules for General Use of Swimming Pool Slides.* Under all circumstances you should prohibit:

- All headfirst entry from slide.
- Horseplay.
- Any slide entries by non-swimmers into deep water, to protect them from drowning.
- Standing on the top of a slide or outside the guardrails.
- Jumping from a slide.
- Diving from a slide.
- Sliding into areas with submerged obstacles, surface objects, or other swimmers.
- Do not engage in extended breath holding activities underwater

* Consult safe use instructions of the pool slide manufacturer

Appendix H

Safety Brochures and Education Programs

This appendix is not part of the American National Standard ANSI/APSP/ICC-5 2011. It is included for information only.

Consumer awareness information is available from the following sources:

- "The Sensible Way to Enjoy Your Inground Swimming Pool" Published by the Association of Pool & Spa Professionals (APSP)
- "Children Aren't Waterproof" Published by the APSP
- "Be Safety Aware" Published by the APSP
- "Layers of Protection" Published by the APSP
- "Pool and Spa Emergency Procedures for Infants and Children" Published by the APSP
- "Knowing How to Dive" Published by the APSP

Copies of the above brochures are available free from the APSP at 703-838-0083, ext. 301.

Also, visit APSP's website at www.APSP.org and consult "Consumer Information."

Safety Education Programs and Materials

Educational programs and materials (i.e., seminars, workshops, brochures, videos, instructional guides, etc.) are available from APSP, NSPF, other aquatic safety groups, and by private firms. As a means of communicating useful safety information to pool owners/operators and users, industry members are permitted to provide such information to owners/operators and to request or require owners/operators to sign a statement that they have received, read and will follow the guidelines.

APSP

2111 Eisenhower Avenue
Alexandria, VA 22314
703-838-0083
www.APSP.org

For a copy of the complete ANSI/APSP/ICC-5 2011 American National Standard for Residential In-ground Swimming Pools contact:

**Association of Pool and Spa Professionals
2111 Eisenhower Avenue
Alexandria, VA 22314
Phone: (703) 838-0083
www.APSP.org**