



BIOSHIELD®

UV DISINFECTION STERILIZER



INSTALLATION AND USER'S GUIDE

IMPORTANT SAFETY INSTRUCTIONS
READ AND FOLLOW ALL INSTRUCTIONS
SAVE THESE INSTRUCTIONS



CUSTOMER SERVICE / TECHNICAL SUPPORT

If you have questions about ordering Pentair Aquatic Systems replacement parts, and pool products, please contact:

Customer Service and Technical Support, USA

(8 A.M. to 4:30 P.M. — Eastern/Pacific Times)

Phone: (800) 831-7133

Fax: (800) 284-4151

Web site

Visit www.pentairpool.com for information about Pentair products.

Sanford, North Carolina (8 A.M. to 4:30 P.M. ET)

Phone: (919) 566-8000

Fax: (919) 566-8920

Moorpark, California (8 A.M. to 4:30 P.M. PT)

Phone: (805) 553-5000 (Ext. 5591)

Fax: (805) 553-5515

TABLE OF CONTENTS

System Features and Specifications	1	UV Lamp Installation	8
Bioshield Features	1	Lamp Styles	8
System Specifications	1	Power Cord Adjustment	8
Sizing Chart	1	Maintenance	9
Pre-Installation Inspection	2	Quartz Sleeve Cleaning	9
Component Diagram	2	Winterizing	9
Power Supplies	2	Troubleshooting	10
Quartz Sleeve and UV Lamp Inspection	3	Replacements Parts	11
Installation	4	Replacement Parts List	11
Quartz Sleeve Assembly and Installation	4		
Sterilizer Installation and Operation	5		
Typical Installation	5		
Mounting the Vessel	6		
Mounting the Power Supply	6		
Mandatory Leak Test	7		
Electrical Connection	7		

IMPORTANT SAFETY INSTRUCTIONS



IMPORTANT NOTICE

This guide provides installation and operation instructions for the UV Sterilizer. Consult Pentair with any questions regarding this equipment.

Attention Installer: This guide contains important information about the installation, operation and safe use of this product. This information should be given to the owner and/or operator of this equipment after installation or left on or near the UV system.

Attention User: This manual contains important information that will help you in operating and maintaining this product. Please retain it for future reference.

IMPORTANT SAFETY INSTRUCTIONS! PLEASE READ PRIOR TO INSTALLATION AND OPERATION!

Strictly follow the instructions within this manual to ensure the health and safety of both, yourself and the UV system. The installation, operation and maintenance of the UV system can only be carried out after reading and understanding the information contained in this manual.

The installation of the UV system must be carried out in accordance with local regulations and codes.

READ AND FOLLOW ALL INSTRUCTIONS



This is the safety alert symbol. When you see this symbol on your system or in this manual, look for one of the following signal words and be alert to the potential for personal injury.

DANGER

Warns about hazards that can cause death, serious personal injury, or major property damage if ignored.

WARNING

Warns about hazards that may cause death, serious personal injury, or major property damage if ignored.

CAUTION

Warns about hazards that may or can cause minor personal injury or property damage if ignored.

NOTE

Indicates special instructions not related to hazards.

Carefully read and follow all safety instructions in this manual and on equipment. Keep safety labels in good condition; replace if missing or damaged.

When installing and using this electrical equipment, basic safety precautions should always be followed, include the following:

DANGER

FAILURE TO FOLLOW ALL INSTRUCTIONS AND WARNINGS CAN RESULT IN SERIOUS BODILY INJURY OR DEATH. THIS UV SYSTEM SHOULD BE INSTALLED AND SERVICED ONLY BY A QUALIFIED POOL SERVICE PROFESSIONAL. INSTALLERS, POOL OPERATORS AND OWNERS MUST READ THESE WARNINGS AND ALL INSTRUCTIONS IN THE OWNER'S MANUAL BEFORE USING THIS PRODUCT. THESE WARNINGS AND THE OWNER'S MANUAL MUST BE LEFT WITH THE POOL OWNER.

WARNING

Ultraviolet light is damaging to your eyes and skin! DO NOT handle or stare at an operating UV lamp. Note that the UV light rays are invisible to the human eye and precautions should be taken to prevent UV energy from entering the eyes.

DANGER

ULTRAVIOLET RADIATION. Disconnect all power from the unit before replacing lamps or servicing the unit.

CAUTION

The quartz sleeve and or the UV lamp shipped with this product may have been broken or damaged during transit. It is therefore essential that the unit be carefully inspected before connecting to electrical power.

CAUTION

To prevent possible fire or electrical shock, only use replacement lamps specified by the manufacturer.

WARNING

DO NOT allow system to exceed 50 PSI (Pounds Per Square Inch).

CAUTION

DO NOT operate this unit above 90 GPM (341 GPM). Operating the product in this manner may result in product failure and voiding of warranty.

DANGER

To avoid possible electrical shock, special care should be taken since water is employed in intended applications. For each of the following situation, DO NOT attempt repairs yourself. Call Pentair Water Pool and Spa, Inc. customer service department at (800) 831-7133 for services or discard the appliance.

DANGER

If unit falls into the water, DO NOT REACH FOR IT! First power down the unit and then retrieve it. If the internal electrical components of the unit get wet, keep the unit powered down until internal electrical components have dried.

DANGER

If the unit shows any sign of water leakage, immediately power down the unit.

CAUTION

Carefully examine the unit after installation. It should not be powered on if there is water on any part not intended to be wet.

WARNING

To reduce the risk of injury, DO NOT permit children to use this product.

WARNING

Bioshield UV systems are designed for low-pressure water applications DO NOT use these units for any application outside of their intended use. The use of attachments not recommended or sold by the original manufacturer may cause unsafe conditions and may void any warranty.

WARNING

This unit must be wired in conjunction with a properly grounded, Ground Fault Circuit Interrupter (GFCI). Only three (3) wire grounded cables suitable for outdoor use should be used to connect this unit. If joining cables for outdoor use, a suitable watertight cable connector must be used. If an extension cord is necessary, a cord with a proper rating should be used. A cord rated for less amperes or watts than the appliance's rating may overheat. Care should be taken to arrange the cord so that it will not be tripped over or pulled. If in doubt consult a qualified electrician.

WARNING

Warping of the UV body may occur when left in direct sunlight without water inside to help dissipate the heat.

WARNING

DO NOT operate the unit in "no-flow" situations.

SAVE THESE INSTRUCTIONS

SYSTEM FEATURES AND SPECIFICATIONS

Bioshield Features

Our low-pressure, high-output mercury vapor germicidal lamps, convert approximately 40% of their electrical input watts into UV-C output watts within the germicidal action spectrum (meaning 40% of electricity used is converted into useful germicidal UV light), the highest UV-C output conversion among all UV lamps.

- UL listed for indoor and outdoor use
- Long lasting, low-pressure, high-output lamps (12,000 hours to 80% efficiency).
- Protective Quartz Sleeve (maximizes UV lamp output and safety)
- Remote Power Supply (10-ft. cable to power supply and 6-ft. cord)
- UV Resistant High Density Plastic UV Vessel
- Non-UV Transmitting Clear Lamp Viewing Ports



System Specifications

Model No.	No. of Lamps	Max Flow Rate @ 30 mJ/cm ²	Lamp Wattage	Amperes (A)	UV-C Output Watts	Dimensions H x W (Inches)	Input Voltage
522635	1	25 GPM	50	0.98-0.43	16	28" x 5.75"	120-277 VAC 50/60 Hz
522636	1	45 GPM	80	0.98-0.43	26	43" x 5.75"	120-277 VAC 50/60 Hz
522637	1	62 GPM	120	0.98-0.43	36	56" x 5.75"	120-277 VAC 50/60 Hz
522638	1	90 GPM	150	1.82	47	70" x 5.75"	120 VAC 50/60Hz
522945	1	90 GPM	150	0.81	47	70" x 5.75"	240 VAC 50/60Hz

Sizing Chart

Model No.	Max Flow Rate @ 30 mJ/cm ²	Turnover Rate in GPM Determined by Daily Hours of Operation									
		6 Hours	8 Hours	10 Hours	12 Hours	14 Hours	16 Hours	18 Hours	20 Hours	22 Hours	24 Hours
522635	25 GPM	9,000	12,000	15,000	18,000	21,000	24,000	27,000	30,000	33,000	36,000
522636	45 GPM	16,200	21,600	27,000	32,400	37,800	43,200	48,600	54,000	59,400	64,800
522637	62 GPM	22,320	29,760	37,200	44,640	52,080	59,520	66,960	74,400	81,840	89,280
522638 & 522945	90 GPM	48,000	48,000	60,000	72,000	84,000	96,000	108,000	120,000	132,000	144,000
Estimated Lamp Life*		5.5	4.1	3.3	2.7	2.3	2.1	1.8	1.6	1.5	1.4

Note (*): Lamp life estimates given above are based on a system that is in continuous operation, 365 days a year. Actual lamp life will vary based on specific operation schedules.

PRE-INSTALLATION INSPECTION

All Bioshield® UV Disinfection Sterilizers are packaged complete, with all necessary components that are required to operate the unit. When unpacking your Bioshield UV system, we recommend that a complete component inventory be taken to ensure that all components are included and accounted for, prior to installation.

Bioshield units have their serial number labels located on the UV vessel and on the power supply label.

The model number of your UV unit can be found in two locations:

1. On the bar code label at the end of the box.
2. On the label placed in the middle of the UV Vessel.

Component Diagram

Please review the component diagram below. Unpack your UV system, and lay out the packaged components for inspection. Please review the information listed in this section to become familiar with the equipment's various parts.

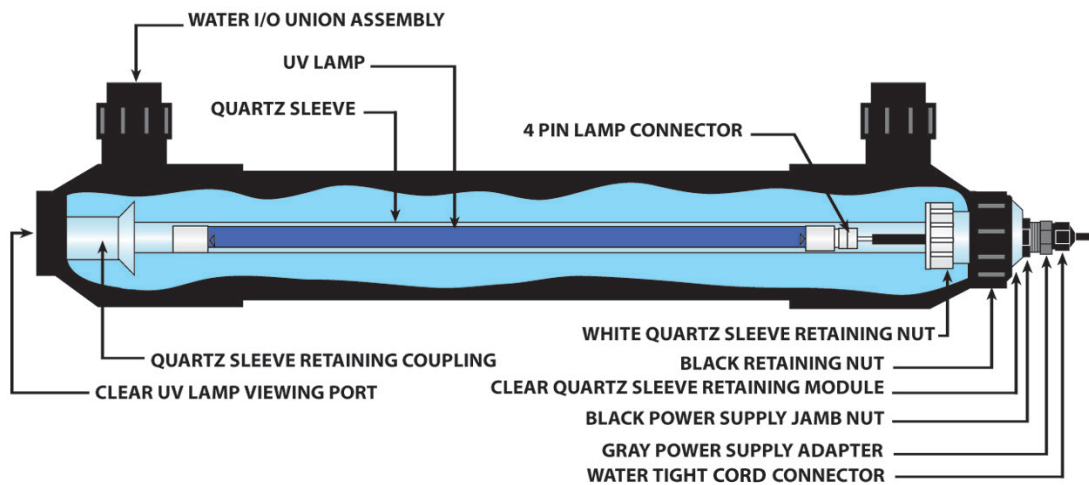

Power Supplies



P/N 523032: 50W, 80W & 120W Models



P/N 523033: 150W (120V) Models
P/N 523053: 150W (240V) Models

Quartz Sleeve and UV Lamp Inspection

Bioshield® UV Disinfection Sterilizers are packaged with their quartz sleeve assembly pre-assembled inside the UV vessel. The UV lamp is packaged separately in a corrugated tube.

The Quartz Sleeve Assembly must be removed from the UV vessel and inspected for damage prior to installation. Extreme care should be used while this procedure is being performed.

Note: DO NOT handle the lamp or quartz sleeve with bare hands. Your hands can deposit oils on the quartz sleeve and lamp that will decrease the efficiency of UV disinfection.

1. Carefully unpack the UV lamp from their corrugated packing tube and inspect for damage including broken glass, cracks, chips, fractures and pin holes. If damage has occurred please contact the place of original purchase immediately.

Note: Save the corrugated lamp packaging after unpacking the UV lamp. Storing the lamp and/or quartz sleeve in this packaging while performing maintenance on the UV system will protect these components from damage or fouling when outside of the vessel.



2. Carefully, remove the quartz sleeve by unthreading the Black Retaining Nut. Gently slide out the quartz sleeve assembly and inspect for damage including chips, cracks and pin holes. If damage has occurred please contact the place of original purchase immediately.



3. After inspection, reassemble the quartz sleeve back into the UV vessel. If installing the unit, perform the Mandatory Leak Test (see page 7).
4. Inspect all other UV system components (power supply, UV vessel unions and necessary mounting clamps) for damage.

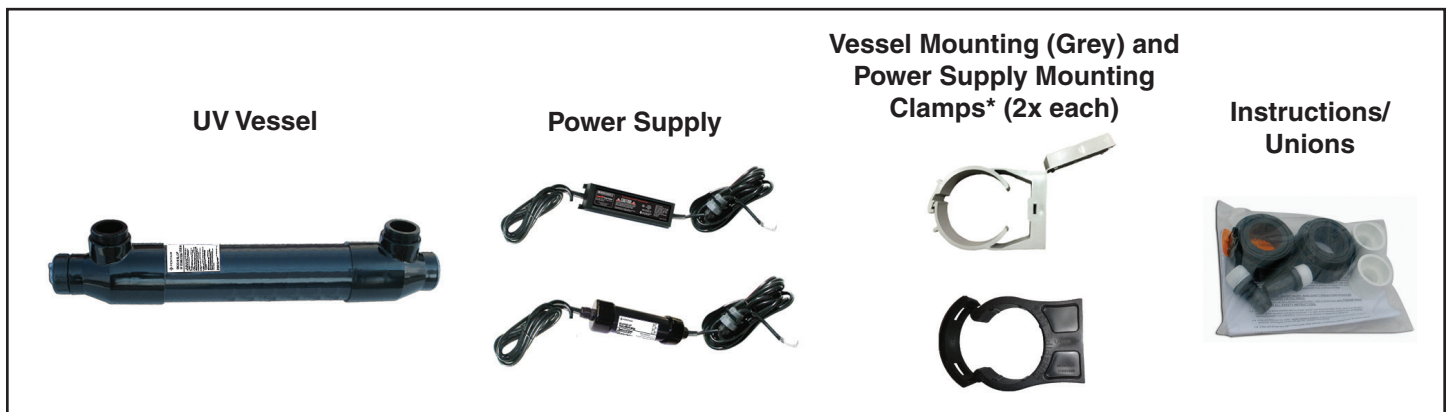

Note (*): Power supply mounting clamps are only provided with 150W UV systems.

After receipt and inspection of the unit, if broken glass is found (including cracks, chips, pin holes and hair line fractures of any kind) please contact Pentair Water Pool and Spa, Inc. at (800) 831-7133.

INSTALLATION

Quartz Sleeve Assembly and Installation



WARNING

Improper assembly may result in water damage to electrical components and unsafe conditions. The manufacturer is not responsible for damage caused by improper re-assembly of these parts.

Quartz Sleeve Assembly Includes:

- 1 Quartz Sleeve
- 2 White Quartz Sleeve Retaining Nut
- 3 Rubber Gasket
- 4 Rubber O-ring
- 5 Clear Quartz Sleeve Module
- 6 Clear Quartz Sleeve Module O-ring
- 7 Power Supply Gasket

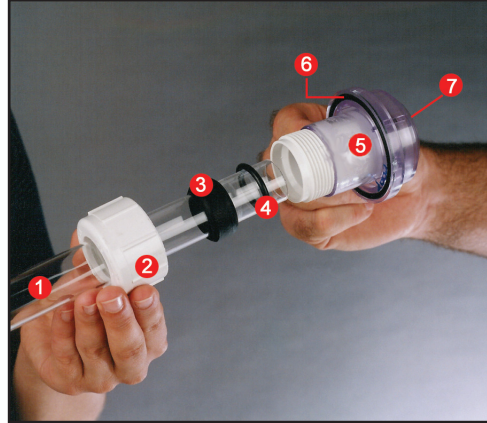

Assembly Instructions

1. Position the white quartz sleeve retaining nut, rubber gasket and rubber o-ring over the open end of the quartz sleeve as shown in **Photo A**.
2. Slide the “open-end” of the quartz sleeve (with nut/gasket and o-ring in position) into the clear quartz sleeve module. See **Photo A**.
3. Thread the white retaining nut onto the clear quartz sleeve module’s male threads and hand-tighten. See **Photo B**.
4. While hand-tightening the white retaining nut onto the clear quartz sleeve module, use your index finger to ensure that the open-end of the quartz sleeve mates smoothly with the inside lip of the clear quartz sleeve module; this signifies a good fit. See **Photo C**.
5. With the quartz sleeve positioned inside the clear quartz sleeve module properly, finish hand-tightening the white retaining nut. When the white retaining nut is tight, the quartz sleeve should appear straight inside the clear quartz sleeve module (see **Photo D**).
Note: If the quartz sleeve appears crooked it may leak. Disassemble and try again.
6. Carefully slide the quartz sleeve assembly into the UV vessel (see **Photo E**). The domed-end of the quartz sleeve should slide into the coupling located on the non-electrical end of the UV vessel (see **Photo F**).

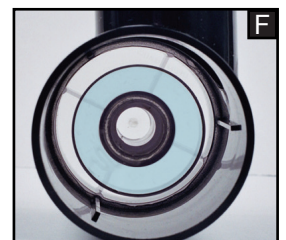
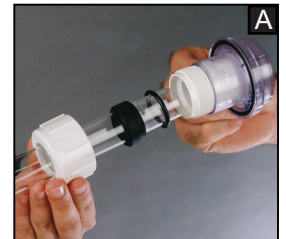

7. With the quartz sleeve assembly properly in place, the quartz sleeve retaining module should sit flush against the top of the UV vessel. See **Photo G**.

Note: Be sure that the clear quartz sleeve module o-ring is properly seated in the bottom of the quartz sleeve module (see item #6 on page 4).

8. Thread the black retaining nut (see **Photo H**) onto the male threads of the UV vessel. Hand tighten only!

9. Using the instructions given on page 7, perform the Mandatory Leak Test. If no leaks are found proceed to page 8, *UV Lamp Installation*, for instructions on installing the UV lamp.



Sterilizer Installation and Operation



DO NOT operate the UV system at flow rates higher than 90 GPM (341 LPM). Operating the product in this manner may result in product failure and voiding of warranty.

Bioshield® UV Disinfection Sterilizers are used in a variety of applications to control waterborne pathogens. Pentair encourages the consideration of the installation recommendations provided here.

Suspended solid debris will absorb UV light and reduce the UV transmittance through water. By operating the Bioshield UV system after the mechanical filter, the unit's overall performance will be increased.

When operating UV sterilizers please consider the recommended water flow rates found in the "Sizing Chart", on page 1.

Typical Installation (See Diagram Below)

This system achieves critical filtering goals, such as good water circulation. The bottom drain/surface skimming capabilities ensure maximum debris removal.

The UV Sterilizer must be positioned after the mechanical filter where it can receive only solid debris free water, optimizing UV transmittance/performance. If you have a flow rate that exceeds the UV vessels rated flow, install a bypass loop.

Note: Before gluing pipe or reducer bushing into the UV vessel's union or socket, remove the quartz sleeve assembly to prevent glue from dripping onto the quartz sleeve.

Note: Use thread seal tape on all threaded connections.

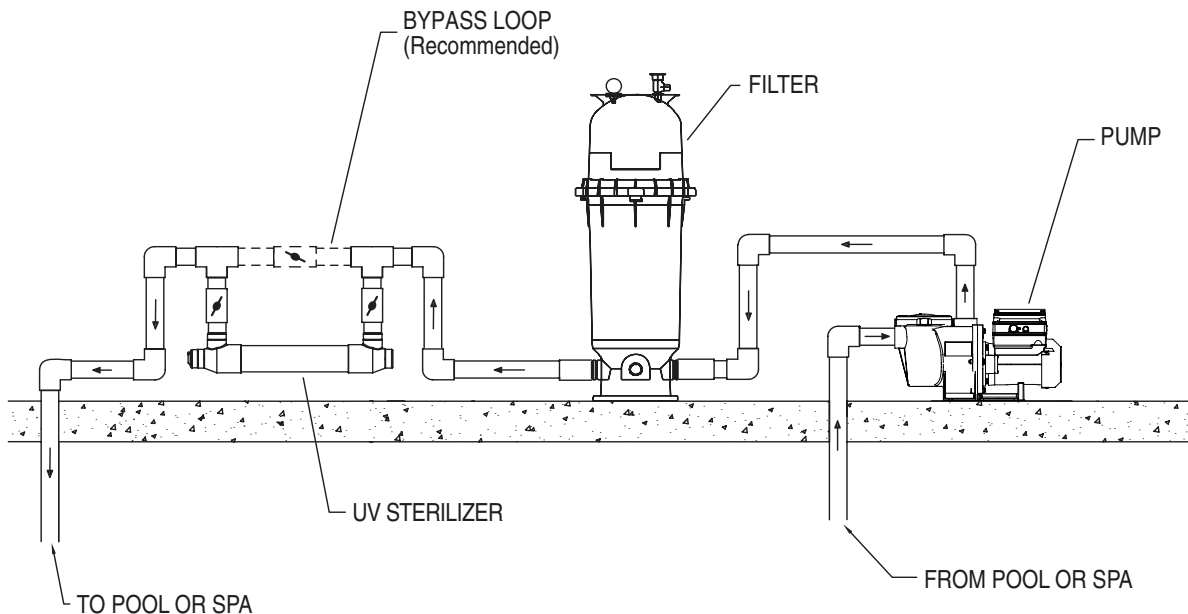

Flow Path: Skimmer(s)/Drain(s) -> Pump -> Filter -> UV Sterilizer -> Pool Returns

Mounting The Vessel

Note: The way UV vessels are mounted/positioned plays a very important role in the unit's performance and degree of safety. We **STRONGLY RECOMMEND** that you follow these instructions and guidelines precisely. Any deviation from these mounting instructions will void any warranty associated with the UV vessel and all its components and may cause unsafe conditions.

CAUTION

Trapped air inside the UV vessel during operation may create excessive heat, thus damaging internal components.

Vertical Vessel Mounting

Mount the Bioshield® UV Disinfection Sterilizer with the electrical end up. Use the bottom port as the inlet with the top port as the outlet.

Note: The UV vessel should be installed with a vertical clearance 1-1/2 times the vessel length. This will allow sufficient room for servicing the unit and replacing the UV lamp



UV Vertical Installation

Horizontal Vessel Mounting

Mount the Bioshield UV system horizontally with the inlet/outlet facing up.

Note: The UV vessel should be installed with a horizontal clearance 1-1/2 times the vessel length. This will allow sufficient room for servicing the unit and replacing the UV lamp.



UV Horizontal Installation

Mounting the Power Supply

The Bioshield UV system's power supply can be mounted in several different ways. The power supply should always be mounted to a surface that is sheltered from rain, splashing, heavy condensation or any other kind of prolonged contact with water.

Note: DO NOT mount the power supply in an extremely confined space where heat and moisture can be retained.

Your UV system will include one of two different power supplies based on the wattage of your unit:

- **50W, 80W and 120W UV systems** include a rectangular power supply. Four screws, one in each corner of the power supply, secure the power supply to the wall or shelf.



- **150W UV systems** include a cylindrical power supply that must be mounted with the two pipe clips packaged with the unit. A single screw at the base of the pipe clip secures it to the wall or shelf. The power supply is then locked into the pipe clip by securing the retaining strap onto the clip.



Mandatory Leak Test

A leak test should be performed each time the quartz sleeve is installed inside the unit's vessel or when the quartz sleeve or gaskets and o-rings are replaced [Once annually]. Performing a leak test is a precautionary measure that will determine whether or not the critical seal between the quartz sleeve and quartz sleeve module has been achieved.

Failure to achieve a proper quartz sleeve/quartz sleeve module seal during Bioshield® UV Disinfection Sterilizer operation will allow water to leak into the inside of the quartz sleeve, potentially damaging the UV lamp and other electrical components, which could develop into dangerous situations.

IMPORTANT NOTE: Failure to perform a leak test could lead to conditions that will void your product warranty.

To Perform Mandatory Leak Test:

1. Prepare the UV system for permanent operation by plumbing it in-line, into a filter system using the plumbing hardware of your choice. If PVC glue is used, follow the glue manufacturer's instructions. If needed, use a bypass assembly for greater water flow control (see the **Figure A**).
2. If UV lamp is installed, with the unit plumbed for operation and the clear quartz sleeve module securely in place, remove the UV lamp from the quartz sleeve module.
3. Roll-up a few paper towels creating a core approximately 3/4-inch diameter, 10-inches long then slide into the open quartz sleeve module port. Insert about 6-inches of the paper towel core down into the quartz sleeve, as shown in **Figure B**.
4. With the paper towel in place, turn on the pump and recirculate water through the UV vessel for at least thirty (30) minutes.
5. After thirty (30) minutes of recirculating water through the UV vessel, remove the paper towels from the quartz sleeve module. Inspect closely for moisture. If the paper towels are completely dry, your leak test is complete and successful.

If moisture is detected on the paper towel the quartz sleeve's rubber gasket and o-ring have failed to achieve a seal and must be re-assembled; repeat the leak test until a seal is achieved. See page 4 for assembly instructions.

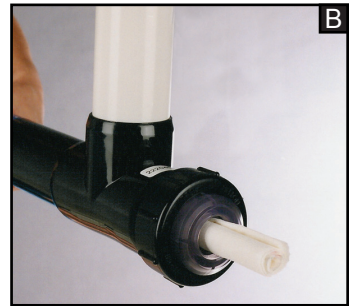
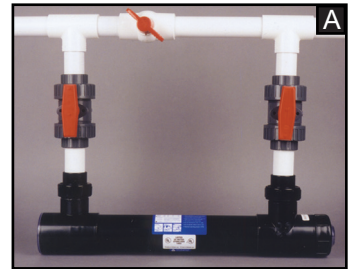

Electrical Connection

The Bioshield UV system is intended to be permanently connected to a Listed Pool Controller (i.e. IntelliTouch® or EasyTouch® Control Systems) or a Listed Mechanical Timer Switch that provides a wiring compartment for the connection of ancillary equipment.

To Connect the UV System to a Listed Pool Controller:

1. Route the UV power supply cable through the 1/2-inch trade size conduit opening in the bottom of the control system enclosure.
2. Use the strain relief provided with the UV system to secure the power supply cable to the control system enclosure.
3. Connect the power supply cable leads to the appropriate terminations inside the control system.

Note: The cable leads are tinned, or provided with Listed Wiring Connectors (i.e. spade or closed loop), to allow for quick connection to either a relay terminal, wiring bar or other conductor termination.

To Connect the UV System to a Listed Mechanical Timer Switch:

The UV system must be wired to the load side of the listed timer switch. This will ensure the UV system only operates when the pump is running. Refer to the instructions and wiring diagram below to properly wire the power supply to a listed timer switch.

1. Wire the power supply's BLACK lead to the terminal marked "L1".
2. Wire the power supply's WHITE lead to the terminal marked "N" (Neutral) in 120 VAC installations or to the terminal marked "L2" in 240 VAC installations.
3. Wire the GREEN lead to the terminal marked "GND" (Ground).

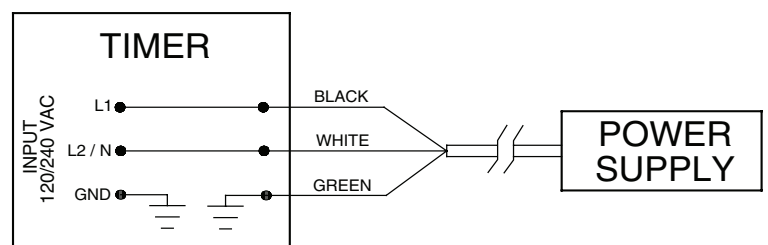

UV Lamp Installation

Lamp Styles

UV lamps are manufactured with color coded ceramic bases. White-capped UV lamps signify a Standard-Output UV lamp while red-capped UV lamps signify a High-Output UV lamp.

Use only red-capped High-Output UV lamps with the Bioshield® UV Disinfection Sterilizer.



Power Cord Adjustment

There should be 4-inches of cord between the Gray Adapter **3** and the 4-pin Lamp Connector **1**. The 4-inch cord distance **2** positions the lamp properly inside the quartz sleeve.

1. The 3/8-inch Threaded Watertight Cord Connector **5** is adjustable. Loosen it gently move the cord through it. Care must be taken when retightening. If the Connector's Rubber Gasket Seal **4** is dislodged during cord adjustment please make sure that it is properly re-seated inside the male threaded portion of the connector.

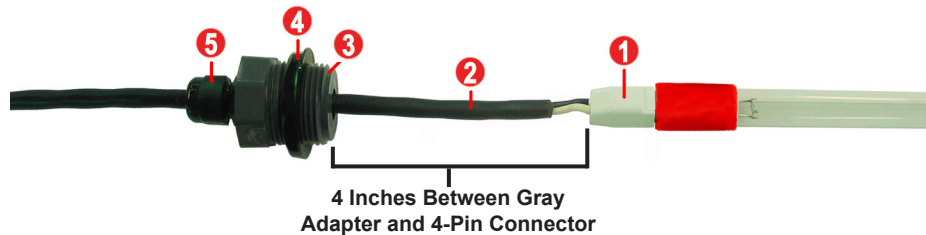

2. After a successful leak test and without the power supply connected to a control box, attach the lamp's 4-pins to the power cord's white 4-pin Connector **1**. Then slide the UV lamp back into the quartz sleeve.

3. Whether the Bioshield® UV Disinfection Sterilizer vessel is mounted horizontally or vertically, care should be taken when installing the UV lamp into the vessel's quartz sleeve. Vertical installations require extra attention to eliminate the chance of the lamp dropping into the quartz sleeve and breaking.

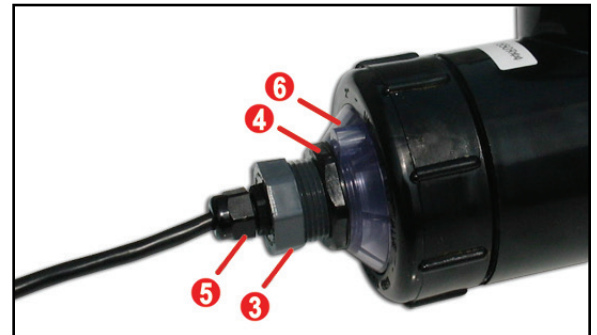

4. With the UV lamp/power cord connection complete and the lamp entirely inside the quartz sleeve, carefully screw down the Gray Power Supply Adapter **3** onto the Clear Quartz Sleeve Module **6**; hand tighten only.
5. Screw down the Black Power Supply Jamb Nut **4** until it makes contact with the Clear Quartz Sleeve Module **6**.

Note: By loosening the 3/8-inch Threaded Watertight Cord Connector **5**, Power Cord **2** adjustments can be made. Make sure the 3/8-inch Threaded Watertight Cord Connector's gasket is properly in place before retightening.

Note: If you do not have the Black Power Supply Jamb Nut **4** back far enough before tightening the Gray Power Supply Adapter **3**, the gray adapter will not make contact with the power supply gasket and will enable outside moisture to enter the quartz sleeve assembly and cause a system failure.

MAINTENANCE

Quartz Sleeve Cleaning

It is recommended that the quartz sleeve be visually inspected for cleaning once every six months of operation. Even the slightest layer of material (slime/dirt) coating the outside of the quartz sleeve can have a substantial affect on UV-C light transmittance through the glass and into the water.

To Clean the Quartz Sleeve (for above water-level installations only):

1. Disconnect power to the UV sterilizer and pool pump at the circuit breaker.
2. Relieve any residual pressure that may remain in the system.
3. Unthread the Black Retaining Nut and gently remove the Quartz Sleeve Assembly and lamp from the UV vessel.
4. Inspect the Quartz Sleeve and clean as needed with a soft, clean cloth.
5. If calcium deposits are present use vinegar or a mixture of water and muriatic acid to dissolve the deposits. If using muriatic acid a ratio of four parts water to one part acid should suffice. Always introduce acid to the water and never introduce the water to the acid.



Muriatic acid is corrosive and can lead to inflammation or burns to body tissue. **ALWAYS** wear rubber gloves, safety glasses and an N-95 dust mask when handling acid to prevent serious bodily injury.

6. Remove ALL vinegar or acid from the quartz sleeve assembly before reassembling.

Winterizing

Using the Bioshield® UV Disinfection Sterilizer in extremely cold temperatures can cause damage to the unit, especially if the water is allowed to freeze inside the equipment. Please note that damage to the product due to freezing is not covered under warranty.

Pentair recommends shutting the UV system down when the temperature consistently falls below 40°F (4°C).

1. Drain all water from the UV system.
2. Disassemble the entire unit and carefully clean both the outside and interior of the UV body and components.
3. Once clean and dry, store the UV vessel and power supply in a dry place for the winter.
4. Return the UV system to service when temperatures consistently return to 40°F (4°C) or greater.

Note: Be sure to replace the quartz sleeve gasket/o-ring and perform a leak test prior to operating the equipment.

TROUBLESHOOTING

Mandatory Leak Test Indicates a Leak

1. Turn off the pool pump at the circuit breaker and be sure all flow to the unit has been stopped.
2. Refer to pages 4-5 for “Quartz Sleeve Assembly” and page 8 for “UV Lamp Installation” (in reverse order) to disassemble the unit.
3. Ensure there are no cracks or breakages in the Quartz Sleeve, that the Quartz Sleeve Gasket and O-ring are properly installed, and that the Quartz Sleeve Retaining Nut has been tightened down completely
4. Reassemble the Quartz Sleeve (see page 4) and repeat the Mandatory Leak Test (see page 7) until there are no indications of a leak.

GFCI/Breaker is Tripping

1. Immediately disconnect power to the Bioshield® UV Disinfection Sterilizer.
2. Turn off the pool pump at the circuit breaker and be sure all flow to the unit has been stopped.
3. Refer to pages 4-5 for “Quartz Sleeve Assembly” and page 8 for “UV Lamp Installation” (in reverse order) to disassemble the unit.
4. Check for water/moisture inside the quartz sleeve.
5. Multiple appliances connected to a circuit protected by one GFCI create the potential for cumulative leakage current resulting in a tripped GFCI.

REPLACEMENT PARTS

Replacement Parts List

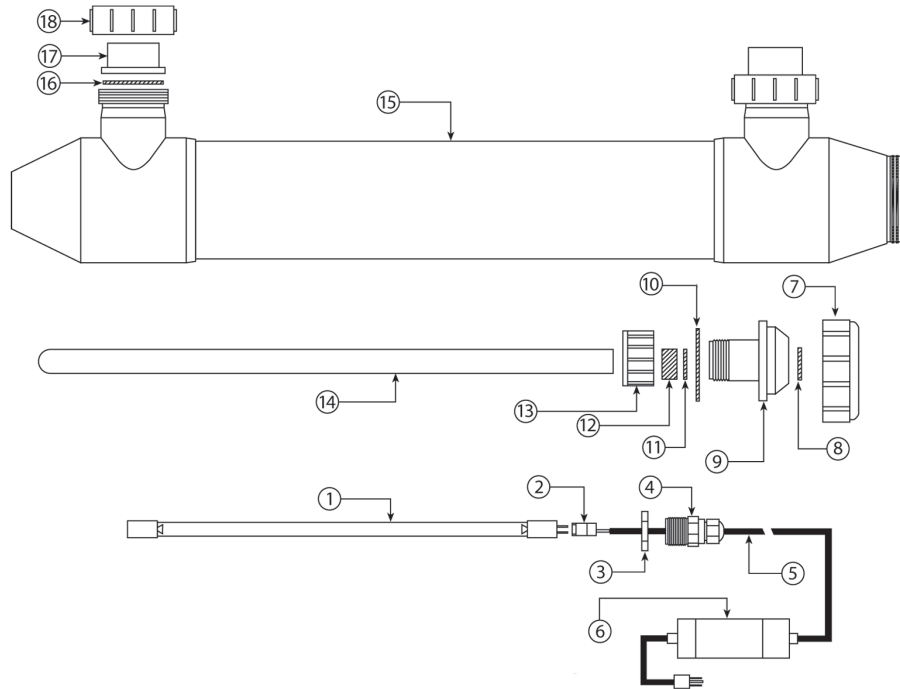

Item #	Description	Item #	Description
1	UV Lamp	11	Quartz Sleeve O-Ring
2	4-Pin Lamp Connector	12	Quartz Sleeve Gasket
3	Black Power Supply Jamb Nut	13	White Quartz Sleeve Gasket/O-Ring Retaining Nut
4	Gray Power Supply Adapter	14	Quartz Sleeve
5	Power Supply Cord	15	UV Sterilizer Vessel
6	Power Supply Module Assembly	16	Water Inlet/Outlet Union O-Ring
7	Black Retaining Nut	17	Water Inlet/Outlet Union Socket Half
8	Power Supply Gasket	18	Water Inlet/Outlet Union Retaining Nut
9	Clear Quartz Sleeve Retaining Module		
10	O-Ring for Clear Quartz Sleeve Retaining Module		

BOLDED PARTS REQUIRE ANNUAL REPLACEMENT

Model No.	UV Lamp P/N	Quartz Sleeve P/N	Power Supply P/N	4-Pin Lamp Connector P/N	Gasket Kit P/N*
522635	523035	523039	523032	523034	523031
522636	523036	523040	523032	523034	523031
522637	523037	523041	523032	523034	523031
522638	523038	523042	523033	523034	523031
522945	523038	523042	523053	523034	523031

Note: Clear Quartz Sleeve Retaining Module (P/N 523054) and white Quartz Sleeve Retaining Nut (P/N 523055) both fit all Bioshield UV Sterilizers

Note (*): Gasket Kit contains item numbers 8, 10, 11, 12 and 17.



1620 HAWKINS AVE., SANFORD, NC 27330 • (919) 566-8000
10951 WEST LOS ANGELES AVE., MOORPARK, CA 93021 • (805) 553-5000
WWW.PENTAIRPOOL.COM

All Pentair trademarks and logos are owned by Pentair or one of its global affiliates. Pentair Aquatic Systems®, IntelliTouch®, EasyTouch® and Bioshield® are registered trademarks of Pentair Water Pool and Spa, Inc. and/or its affiliated companies in the United States and/or other countries. Unless expressly noted, names and brands of third parties that may be used in this document are not used to indicate an affiliation or endorsement between the owners of these names and brands and Pentair Water Pool and Spa, Inc. Those names and brands may be the trademarks or registered trademarks of those third parties. Because we are continuously improving our products and services, Pentair reserves the right to change specifications without prior notice. Pentair is an equal opportunity employer.

© 2016 Pentair Water Pool and Spa, Inc. All rights reserved. This document is subject to change without notice.



P/N 960080 REV. A 6/29/16