

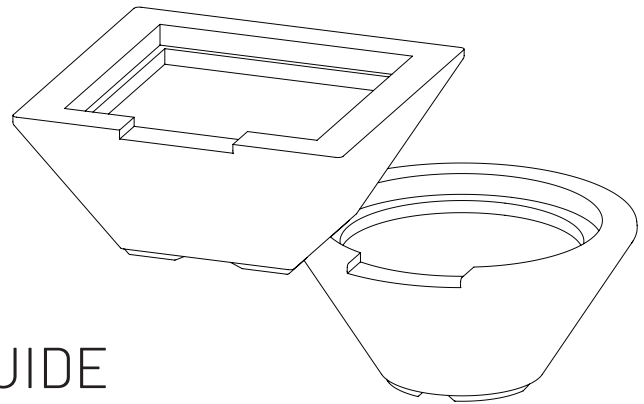

MAGICFLAME™

FIRE AND WATER BOWL



INSTALLATION AND USER'S GUIDE

IMPORTANT SAFETY INSTRUCTIONS READ AND FOLLOW ALL INSTRUCTIONS SAVE THESE INSTRUCTIONS

⚠ WARNING FOR YOUR SAFETY - READ BEFORE OPERATING!
If the information in this manual is not followed exactly, a fire or explosion may result causing property damage, personal injury, or loss of life. For additional free copies of this manual; call (800) 831-7133.

⚠ DANGER RISK OF FIRE OR EXPLOSION! Improper installation and/or servicing can result in flammable gas leaks, which could result in death, serious injury, or major property damage.

⚠ DANGER FIRE OR EXPLOSION HAZARD!

IF YOU SMELL GAS:

- Shut off gas to the appliance.
- Extinguish any open flame.
- If odor continues, leave the area immediately.
- After leaving the area, call your gas supplier or fire department.

Failure to follow these instructions could result in fire or explosion, which could cause property damage, personal injury, or death.

⚠ WARNING FOR OUTDOOR USE ONLY! Installation and service must be performed by a qualified installer, service agency, or the gas supplier.

⚠ WARNING Do not store or use gasoline, or other flammable vapors and liquids, in the vicinity of this or any other appliance.
An LP-cylinder not connected for use shall not be stored in the vicinity of this or any other appliance.

⚠ DANGER CARBON MONOXIDE HAZARD! This appliance can produce carbon monoxide which has no odor.
Using this appliance in an enclosed space can kill you. Never use this appliance in an enclosed space such as a camper, tent, car, or home.

INSTALLER: LEAVE THIS MANUAL WITH THE APPLIANCE.
CONSUMER: RETAIN THIS MANUAL FOR FUTURE REFERENCE.

IMPORTANT SAFETY INSTRUCTIONS



This guide provides important installation, operation and maintenance instructions related to this equipment. Consult Pentair or a qualified pool professional with any questions.

Attention Installer: This guide contains important information that helps ensure proper and safe installation, operation and maintenance of this equipment. Ensure this guide is given to the pool owner and/or operator of this equipment after installation.

Attention User: This guide contains important information that helps ensure proper and safe operation and maintenance of this equipment. Retain this guide for future reference.

Call (800) 831-7133 for additional free copies of these instructions or product labels. Refer to www.pentair.com for more information.

READ AND FOLLOW ALL INSTRUCTIONS SAVE THESE INSTRUCTIONS



This is the safety alert symbol. When you see this symbol in this guide or on the product itself, look for one of the following signal words and be aware of the potential for personal injury.



Warns of hazards that may cause death, serious personal injury, or major property damage if ignored.



Warns of hazards that may cause serious personal injury or major property damage if ignored.



Warns of hazards that may or can cause minor personal injury or property damage if ignored.

Carefully read and follow all instructions in this guide or displayed on the equipment. Ensure all product labels are kept in good condition and replace missing or damaged labels immediately.



INSTALLERS, POOL OPERATORS, AND OWNERS MUST READ ALL WARNINGS AND INSTRUCTIONS IN THIS GUIDE BEFORE USING THIS EQUIPMENT. FAILURE TO CAREFULLY READ AND FOLLOW ALL INSTRUCTIONS CAN RESULT IN SERIOUS BODILY INJURY OR DEATH.



THIS PRODUCT MUST BE INSTALLED AND SERVICED BY A QUALIFIED SERVICE PROFESSIONAL OR GAS SUPPLIER. Improper installation, adjustment, alteration, or maintenance can cause property damage, personal injury or death. Some jurisdictions require that installers be licensed. Check with your local building authority about licensing requirements.



Most states and local codes regulate the construction, installation, and operation of public pools and spas, and the construction of residential pools and spas. It is important to comply with these codes, many of which directly regulate the installation and use of this product. Consult your local building and health codes for more information.



Ensure installer follows all applicable national and local codes and the appliance is serviced annually by a professional gas technician certified in the United States by the National Fireplace Institute (NFI).



FIRE OR EXPLOSION HAZARD! Failure to follow these instructions could result in a fire or explosion, causing property damage, personal injury, or loss of life.

IF YOU SMELL GAS:

- Shut off gas to the appliance.
- Extinguish any open flame.
- If odor continues, leave the area immediately.
- After leaving the area, call your gas supplier or fire department.



RISK OF FIRE OR EXPLOSION FROM INCORRECT FUEL USE OR FAULTY FUEL CONVERSION! DO NOT ATTEMPT TO OPERATE A FIRE FEATURE SET UP FOR NATURAL GAS ON PROPANE OR VICE VERSA. SERIOUS MALFUNCTION OF THE BURNER CAN OCCUR WHICH MAY RESULT IN DEATH.

Only a qualified service professional or gas supplier should attempt to convert from one fuel to the other. If fuel conversion is necessary, consult your Pentair dealer.

Verification of fuel type can be done by checking the label on the bottom side of the control box.



RISK OF CARBON MONOXIDE POISONING OR ASPHYXIATION! This product can produce carbon monoxide, a tasteless and odor-less toxic gas. Failure to follow these instructions can result in death, permanent brain damage, or other serious injury.



CARBON MONOXIDE IS DEADLY! Exhaust from this fire feature contains toxic levels of carbon monoxide, as dangerous, poisonous gas you cannot see or smell. Improper installation and/or operation could create carbon monoxide gas which could cause serious injury or death.

Symptoms of carbon monoxide exposure or poisoning include: Dizziness, headache, nausea, weakness, tiredness, muscle twitching, vomiting, and/or the inability to think clearly. **IF YOU EXPERIENCE ANY OF THESE SYMPTOMS, IMMEDIATELY TURN OFF THE GAS SUPPLY, LEAVE THE AREA AND FIND FRESH AIR IMMEDIATELY. THE PRODUCT MUST BE THOROUGHLY TESTED BY A QUALIFIED SERVICE PROFESSIONAL OR GAS SUPPLIER BEFORE RESUMING OPERATION.**



The U.S. Consumer Product Safety Commission warns that carbon monoxide is an "invisible killer". Carbon monoxide is a colorless and odorless gas.

1. Carbon monoxide is produced by burning fuel, including natural gas and propane.
2. Proper installation, operation and maintenance of fuel-burning appliances in the home is the most important factor in reducing carbon monoxide poisoning.
3. Be sure that fuel burning appliances such as fire bowls are installed by professionals according to manufacturer's instructions and codes.
4. Always follow the manufacturer's directions for safe operation.
5. Have the fire bowls (including vents) inspected and serviced annually by a trained service technician.
6. Examine vents regularly for blockage.
7. Install battery-operated carbon monoxide alarms. The alarms should be certified to the requirements of the most recent UL, IAS, CSA and IAPMO standard for carbon monoxide alarms. Test carbon monoxide alarms regularly and replace dead batteries.



THIS PRODUCT IS INTENDED FOR OUTDOOR USE ONLY! Never install or operate this product in an enclosed space where carbon monoxide may accumulate.



NEVER store gasoline, cleaning fluids, varnishes, paints, or other volatile flammable liquids near heater.



NEVER place unopened containers into the fire feature. Heating such containers will cause pressure to build-up and may cause the container to burst, causing personal injury or property damage.



This product is **NOT** intended for cooking. Do not place anything on or in the fire.

IMPORTANT SAFETY INSTRUCTIONS

⚠ WARNING If burner goes out, turn gas to off position and wait several minutes. Once gas has dissipated, light following the manufacturer's recommendations.

⚠ WARNING DO NOT USE SOLID FUELS. THE FIRE FEATURE IS INTENDED FOR USE WITH NATURAL GAS OR PROPANE ONLY! NEVER USE ALTERNATIVE FUELS!

⚠ WARNING This fire feature is equipped with an unconventional gas control valve that is factory set and not adjustable. DO NOT attempt to adjust gas flow using this valve. Improper installation, adjustment, alteration, service or maintenance can cause property damage, personal injury or loss of life. Installation or service must be performed by a qualified installer, service agency or the gas supplier. If this control is replaced, it must be replaced with an identical control.

⚠ WARNING NEVER allow loose fitting garments to come in contact with hot surfaces or open flames. Garments may ignite and result in serious personal injury.

⚠ WARNING Clothing or other flammable materials should not be hung from, or placed on or near, the fire feature.

⚠ WARNING If overheating occurs, or the gas supply fails to shut off, close the main gas supply valve to the fire feature.

⚠ WARNING Be aware of the risks of high surface temperatures and should stay at a safe distance to avoid burns or clothing ignition.

⚠ WARNING DO NOT allow children to play on or around the fire feature or any associated equipment.

⚠ WARNING ALWAYS closely supervise young children when around this product or pool.

⚠ WARNING DO NOT use this fire feature if any part or component has been submerged in water. Immediately call a qualified service professional.

⚠ WARNING **RISK OF ELECTRICAL SHOCK OR ELECTROCUTION!** ALWAYS disconnect power at the circuit breaker before servicing this product. Failure to do so could result in death or serious injury.



⚠ WARNING The electrical supply must be installed by a licensed or certified electrician or other qualified professional in accordance with the National Electrical Code (NEC) and all applicable local codes and ordinances.

⚠ DANGER FAILURE TO FOLLOW THESE INSTRUCTIONS COULD RESULT IN PROPERTY DAMAGE, PERSONAL INJURY, OR DEATH.

⚠ WARNING For countries in compliance with International Electrotechnical Commission (IEC) regulatory standards: The fire feature must be installed by a licensed or certified electrician or other qualified professional, in accordance with IEC 364-7-702 and all applicable local codes and ordinance. Improper installation will create an electrical hazard, which could result in death or serious injury to pool user, installer or other due to electrical shock and may also cause damage to the property.

⚠ CAUTION Label all wires prior to disconnection when servicing controls. Wiring errors can cause improper and dangerous operation, as well as damage electrical components.

⚠ CAUTION This fire feature is a 12 VAC system. Connect the fire feature to 12 VAC power only. When using a Junction Box, connect 12 VAC to junction box terminals. Never connect the fire feature directly to high voltage lines.

Ensure the pool or spa meets the requirements of the current National Electrical Code (NEC) Article 680-22 and all local codes and ordinances. A licensed or certified electrician must install the electrical system to meet or exceed those requirements before the fire bowl is installed. **Some of the requirements of the National Electrical Code which the pool electrical system must meet:**

- The circuit has a Ground Fault Circuit Interrupter (GFCI) for 120 VAC line voltage models, and has an appropriately rated circuit breaker. The conductors on the load side of the GFCI circuit shall not occupy conduit, boxes, or enclosures containing other conductors unless the additional conductors are also protected by a GFCI. Refer to local codes for complete details.
- The Junction Box and the low voltage transformer is located at least 4 in (10.2 cm) above ground level or 8 in (20.3 cm) above maximum water level in the bowl, whichever is higher. The Junction Box must be at least 2 ft (1.2 m) from the edge of the pool.
- To be certain that the pool or spa electrical system meets all applicable requirements, the electrician should also consult the local building department.

CUSTOMER SERVICE / TECHNICAL SUPPORT

Hours: 9:00AM to 7:00PM EST (6:00AM - 4:00PM PST)

Call: (800) 831-7133

Visit: www.pentair.com

Fax: (800) 284-4151

TABLE OF CONTENTS

IMPORTANT SAFETY INSTRUCTIONS	1	MAINTENANCE	16
INSTALLATION	4	General Maintenance	16
Feature Overview	4	Annual Maintenance	16
Installation Guidelines	4	Winterizing the Fire Feature	16
Bowl Dimensions	6	Replacing the Pilot Orifice	17
Gas Requirements	7	Replacing the Igniter	17
Natural Gas Requirements	7	Replacing the Pilot/Igniter Assembly	18
Propane Gas Requirements	7	Replacing the Burner Orifice	19
Pipe Sizing Charts	8	Replacing the Pilot Sensor	21
Gas Line Installation	9	TROUBLESHOOTING	22
Electrical Installation	10	REPLACEMENT PARTS	23
Plumbing/Water Installation	10		
Bowl Installation	11		
Installing the Burner Assembly	13		
Adding Fire Media	14		
OPERATION	15		
Operation Guidelines	15		
Operating the Fire Feature	15		
Lighting the Fire Feature	15		

INSTALLATION

- ⚠ DANGER** **RISK OF FIRE OR EXPLOSION!** Improper installation can result in flammable gas leaks, which could result in death, serious injury, or major property damage. Installation must be performed by a qualified service professional or gas supplier.
- ⚠ DANGER** **RISK OF CARBON MONOXIDE POISONING OR ASPHYXIATION!** This product can produce carbon monoxide, a tasteless and odorless toxic gas. Improper installation may lead to a buildup of carbon monoxide, which can result in death, permanent brain damage, or other serious injury. Installation must be performed by a qualified service professional or gas supplier. NEVER install or operate this product in an enclosed space where carbon monoxide can accumulate.
- ⚠ WARNING** **RISK OF ELECTRICAL SHOCK OR ELECTROCUTION!** Improper installation could result in serious injury. This product is only available for 12 VAC power. For supply connections, use only an isolating low voltage power supply with ungrounded output, evaluated and listed by a Nationally Recognized Testing Laboratory (NRTL).

Follow the instructions given in this manual to ensure proper installation, operation and maintenance of your MagicFlame™ Fire and Water Bowl. Failure to follow these instructions may void the product warranty.

For additional information, or if you have questions regarding these instructions, contact Pentair Technical Service at (800) 831-7133.

FEATURE OVERVIEW

- Water fountain bowl and/or electronic ignition gas burner.
- 12 VAC low voltage power supply.
- Durable UV-resistant glass fiber reinforced concrete bowl.
- 85,000 BTU rating.
- Low voltage (60 W maximum) and minimal water flow requirements.
- Capable of use with natural gas or propane.
- (*) Burner assemblies are certified to ANSI Z21.97-2017/ CSA 2.41-2017
- Outdoor Decorative Gas Appliances.



Certified to ANSI Z21.97-2017/
CSA 2.41-2017 - Outdoor
Decorative Gas Appliances*

INSTALLATION GUIDELINES

IMPORTANT! The fire feature is shipped from the manufacturer for use natural gas at the manufacturer. **If conversion to propane is required, it must be performed by a qualified service professional or gas supplier using Pentair specified and approved parts.**

For conversion instructions refer to *REPLACING THE PILOT ORIFICE*, page 17 and *REPLACING THE BURNER ORIFICE*, page 19.

- Installation must be in accordance with all local codes and/or the latest edition of the National Fuel Gas Code, ANSI Z223.1 and the latest edition of the National Electrical Code, NFPA 70 (US).
 - Note:** In Canada, installation must be in accordance with the latest CAN/CGA-B149.1 or .2 and CSA C22.1 Canadian Electric Code, part 1.
- Provide a minimum of 6 ft [1.8 m] clearance above the burner.
- Provide a minimum of 4 ft [1.2 m] horizontal clearance between the fire feature and any combustible surfaces or objects.
- Ensure install location provides proper drainage.
- Properly anchor to a solid mounting surface.
- Ensure all openings at base and burner area are unobstructed.
- Mounting surface must be level in all directions.
- Electrical power, gas and water outlets should be located in the center of the bowl.

- Continue to next page -

INSTALLATION GUIDELINES (continued)

- Minimum 15 GPM [56.8 LPM] flow for water features.
- If the pool has multiple lights, water features, etc., it is recommended that the fire/water features be run independent of each other, using a separate transformer for each group or type of water feature. Otherwise all water features connected to the same transformer will operate together.
- 3/4" hose adapter needed to connect fire/water bowl to water line.
- 1-1/2" water supply line recommended.
- Install a check valve in the water supply line to prevent bowl from draining when not in use.
- Install an adjustable control valve in the water supply line to allow water flow adjustments.
- Install the bowl so that the water is flowing into the pool, spa, or fountain.
- Spillover scupper must be no less than 3 inches [7.6 cm] over finished edge of pool, spa coping or fountain pedestal.
- Separate bond wire required for each bowl.
- Ensure the fire feature has a way to drain water. Providing proper drainage is critical.
- If installing the fire feature on a column, ensure the bowl is anchored properly.
- Ensure the electrical and gas line hole is sealed to prevent water cannot penetrating the coping surface under the bowl.

BOWL DIMENSIONS

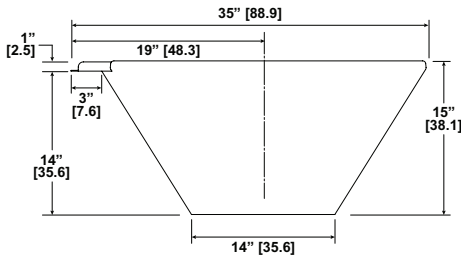
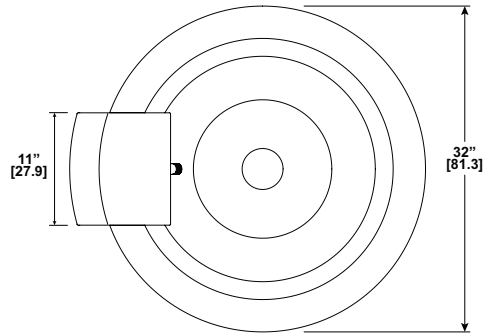

WATER BOWL - ROUND	
Bronze	580175
Pewter	580176
Natural	580177
White	580178
Black	580179

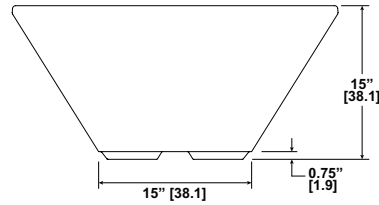

FIRE BOWL - ROUND	
Bronze	580165
Pewter	580166
Natural	580167
White	580168
Black	580169

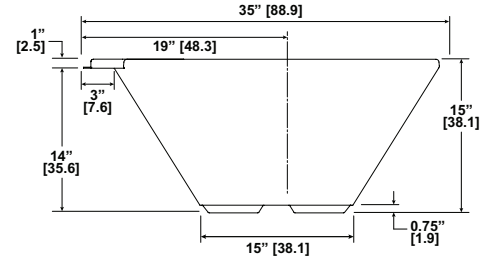

FIRE/WATER BOWL - ROUND	
Bronze	580170
Pewter	580171
Natural	580172
White	580173
Black	580174

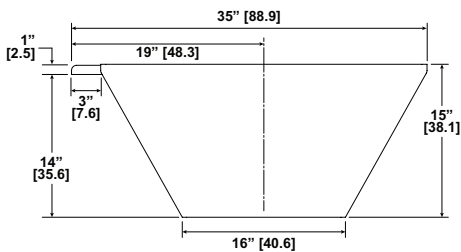
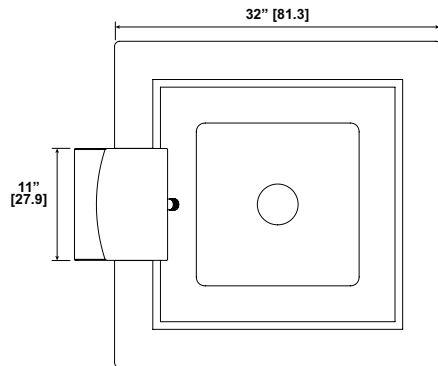

WATER BOWL - SQUARE	
Bronze	580190
Pewter	580191
Natural	580192
White	580193
Black	580194

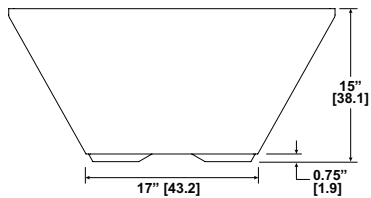

FIRE BOWL - SQUARE	
Bronze	580180
Pewter	580181
Natural	580182
White	580183
Black	580184

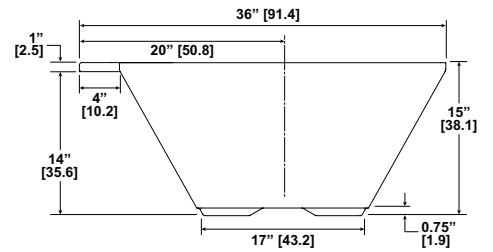

FIRE/WATER BOWL - SQUARE	
Bronze	580185
Pewter	580186
Natural	580187
White	580188
Black	580189

GAS REQUIREMENTS

To verify the fuel type (either propane or natural gas) the fire feature is designed to use, refer to the label on the bottom of the control box.

Natural Gas (NG) Requirements

Ensure that the service supplying the fire feature is fitted with a positioned shut off valve that is easily accessible.

Always check the rating plate to make sure the gas supply you are connecting to is the gas intended for your fire feature. The installation of this appliance to a fixed piping system must conform with local codes or, in the absence of local codes, to the National Fuel Gas Code, ANSI 2223.1, NFPA 54; National Fuel Gas Code; Natural Gas and Propane Installation Code, CSA 8149.1 as applicable.

Natural gas connection must be performed by a licensed contractor or local gas company representative.

Supply Pressure

Minimum: 6.3" W.C.

Normal: 7.0" W.C.

Maximum: 7.7" W.C. (1/2 psi)

Pressure Testings

If the fire feature is installed with a fixed fuel piping system and equipped with an appliance gas pressure regulator, the fire feature and its individual shut-off valve must be disconnected from the gas supply piping system during any pressure testing of the system at test pressure in excess of 1/2 psi (3.5 kPa).

The fire feature must be isolated from the gas supply piping system by closing its individual manual shut off valve during any pressure testing of the gas supply piping system at test pressures equal to or less than 1/2 psi (3.5 kPa).

Refer to the table below and *Natural Gas (NG) Pipe Sizing, page 8* for natural gas line requirements.

Propane Gas (LP) Requirements

⚠ WARNING RISK OF EXPLOSION IF UNIT IS INSTALLED NEAR PROPANE GAS STORAGE! Locate the fire bowl away from propane gas storage and filling equipment as specified by the Standard for the Storage and Handling of Liquefied Petroleum Gases, CAN/CSA B149.2 (latest edition) or ANSI/NFPA 58 (latest edition).

A propane tank is not included with the fire feature and will need to be provided.

Always check the rating plate to make sure the gas supply you are connecting to is the gas intended for your fire feature. The installation of this appliance to a fixed piping system must conform with local codes or, in the absence of local codes, to the National Fuel Gas Code, ANSI 2223.1, NFPA 54; National Fuel Gas Code; Natural Gas and Propane Installation Code, CSA 8149.1, or Propane Storage and Handling Code, CSA 8146.2 as applicable.

Manifold Pressure

For plumbed-in Propane Gas installation, use a properly sized regulator according to supply pressure.

Supply Pressure

Minimum: 9.9" W.C.

Normal: 11.0" W.C.

Maximum: 12.1" W.C. (½ psi)

Refer to the table below and *Liquid Propane (LP) Gas Pipe Sizing, page 8* for propane gas line requirements.

	SIZE OF PIPE (IN.)												
	1/2"		3/4"		1"		1-1/4"		1-1/2"		2"		
	NG	LP	NG	LP	NG	LP	NG	LP	NG	LP	NG	LP	
1 BOWL	10' [3.1 m]	80' [24.4 m]	50' [15.2 m]	300' [91.4 m]	175' [53.3 m]	450' [137.2 m]	400' [121.9 m]	-	-	-	-	-	-
2 BOWLS	-	20' [6.1 m]	10' [3.1 m]	80' [24.4 m]	40' [12.2 m]	250' [76.2 m]	200' [61 m]	-	400' [121.9 m]	-	-	-	-
3 BOWLS	-	10' [3.1 m]	-	30' [9.1 m]	20' [6.1 m]	125' [38.1 m]	70' [21.3 m]	450' [137.2 m]	200' [61 m]	-	450' [137.2 m]	-	-
4 BOWLS	-	-	-	20' [6.1 m]	10' [3.1 m]	60' [18.3 m]	50' [15.2 m]	250' [76.2 m]	125' [38.1 m]	500' [152.4 m]	400' [121.9 m]	-	-
5 BOWLS	-	-	-	10' [3.1 m]	-	40' [12.2 m]	30' [9.1 m]	150' [45.7 m]	70' [21.3 m]	400' [121.9 m]	200' [61 m]	-	-
6 BOWLS	-	-	-	10' [3.1 m]	-	30' [9.1 m]	20' [6.1 m]	125' [38.1 m]	50' [15.2 m]	250' [76.2 m]	175' [53.3 m]	-	-

- **NG** = Natural Gas / **LP** = Liquid Propane
- 2" - 3" WC maximum pressure drop

PIPE SIZING CHARTS

The sizing charts below list the specific pipe sizes required for the amount of BTUs for new gas line installations. If you are using an existing gas line you must consider existing gas line capacities to ensure proper pressure. Consult a qualified service professional or gas supplier for more details.

Natural Gas (NG) Pipe Sizing

LENGTH OF PIPE (FT.)	SIZE OF PIPE (IN.)								
	1/2"	3/4"	1"	1-1/4"	1-1/2"	2"	2-1/2"	3"	4"
10'	108	230	387	793	1237	2259	3640	6434	-
20'	75	160	280	569	877	1610	2613	5236	9521
30'	61	129	224	471	719	1335	2165	4107	7859
40'	52	110	196	401	635	1143	1867	3258	6795
50'	46	98	177	364	560	1041	1680	2936	6142
60'	42	89	159	336	513	957	1559	2684	5647
70'	38	82	149	317	476	896	1447	2492	5250
80'	36	76	140	239	443	840	1353	2315	4900
90'	33	71	133	275	420	793	1288	2203	4667
100'	32	68	126	266	411	775	1246	2128	4518
125'	28	60	117	243	369	700	1143	1904	4065
150'	25	54	105	215	327	625	1008	1689	3645
175'	23	50	93	196	303	583	993	1554	3370
200'	22	47	84	182	280	541	877	1437	3160
300'	17	37	70	145	224	439	686	1139	2539

- Natural Gas flow shown in thousands of BTU. One cubic foot of natural gas = 1000 BTU.
- Nominal pressure at the burner is 3.5 inches of water column (Typical machine supply 5 to 7 inches).
- Pipe length must include additional length for all fittings. Add approximately 5 ft [1.5 m] of pipe per fitting.
- **Example:** A burner that requires 440,000 BTU would need 20 ft [6.1 m] of 1-1/4 inch pipe.

Liquid Propane (LP) Gas Pipe Sizing

LENGTH OF PIPE (FT.)	SIZE OF PIPE (IN.)								
	1/2"	3/4"	1"	1-1/4"	1-1/2"	2"	2-1/2"	3"	4"
10'	275	567	1071	2205	3307	6221	10140	17990	35710
20'	189	393	732	1496	2299	4331	7046	12510	25520
30'	152	315	590	1212	1858	3465	5695	10110	20620
40'	129	267	504	1039	1559	2992	4778	8481	17300
50'	114	237	448	913	1417	2646	4343	7708	15730
60'	103	217	409	834	1275	2394	3908	6936	14150
80'	89	185	346	724	1086	2047	3329	5908	12050
100'	78	162	307	630	976	1811	2991	5309	10830
125'	69	146	275	567	866	1606	2654	4711	9613
150'	63	132	252	511	787	1496	2412	4281	8736
200'	54	112	209	439	665	1282	2083	3618	7382
250'	48	100	185	390	590	1138	1808	3210	6549
300'	43	90	168	353	534	1030	1637	2905	5927
350'	40	83	155	325	491	947	1505	2671	5450
400'	37	77	144	303	458	887	1404	2492	5084

- Liquid Propane (LP) gas flow shown in thousands of BTU. One cubic foot of propane gas = 2516 BTU.
- This chart refers to low pressure LP, after regulation. Standard nominal pressure at the burner is 11 inches of water column.
- Pipe length must include additional length for all fittings. Add approximately 5 ft [1.5 m] of pipe per fitting.
- **Example:** A burner that requires 440,000 BTU would need 20 ft [6.1 m] of 1-inch pipe.

GAS LINE INSTALLATION

Keep pipe length and elbows to a minimum to eliminate unnecessary pressure drops. Corrugated flex gas lines should not be used.

1. Determine the proper gas line size based on fuel input requirements (BTU/HR), gas pressure and the distance from the gas pressure regulator to the fire/water bowl.
2. Route gas lines underground to each bowl.
3. The stubbed-out end should be fitted with a 1/2-inch NPT ball valve shutoff (rated for gas usage) and a flare fitting sized for the same size gas hose that is attached to the control box.
4. Piping must be reduced to 1/2-inch NPT pipe size at each bowl.
5. At each bowl, install a 90-degree gas pipe elbow on the gas line to simplify installation of the gas hose.
 - Note:** Do not kink or make a tight radius bend on the gas hose.
 - Note:** Gas, electrical, and water connections must be located at the center of each bowl.
6. Install a ball valve after the elbow.
7. Install a 1/2-inch flare fitting onto ball valve.
8. Install a 1/2-inch flex hose to the flare fitting at the ball valve.
9. Secure the other end of flex line to the control box.
10. Tighten all fittings with a wrench, do not hand tighten!
11. Test the gas lines for leaks and loss of pressure over a 24-hour period. When you are finished testing and have found no leaks, cover the pipes, level the ground and finish setting the foundation.

Note: Your gas supplier can verify the gas flows and pressures available for your installation.

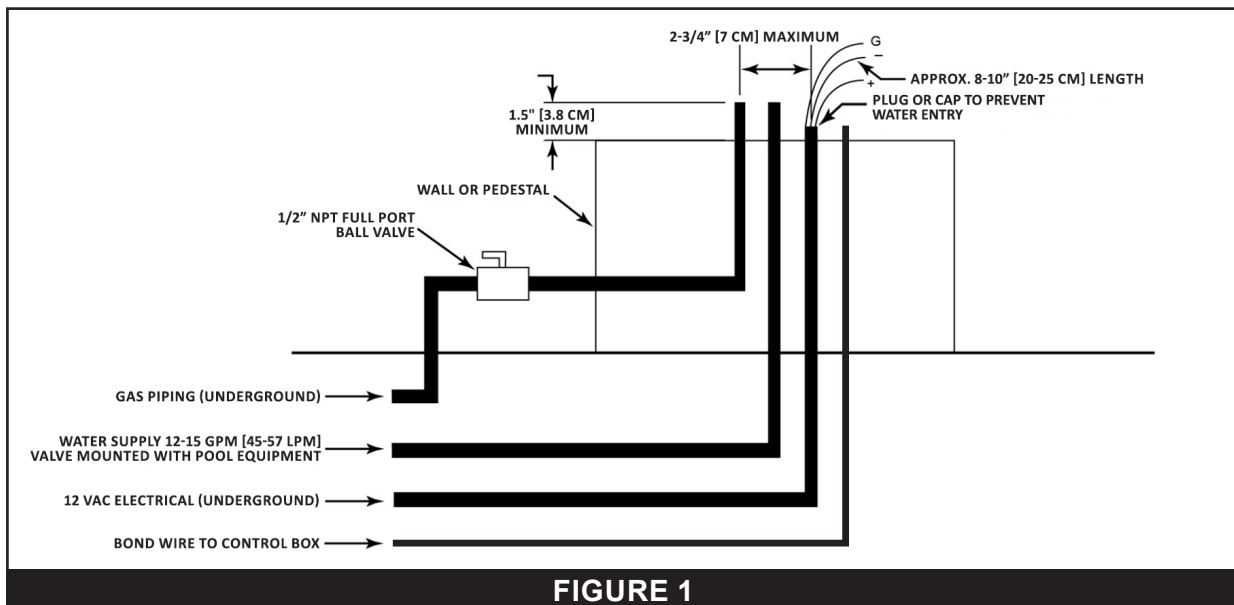

ELECTRICAL INSTALLATION

When using multiple fire features, the total allowable wattage is 300 Watts. A transformer should only be loaded to 80% of its capability.

For example: A 300 watt transformer should have no more than 240 watts attached to it. A single MagicFlame is 60 Watts maximum. No more than four MagicFlame features can be connected to a 300 watt transformer.

1. **Disconnect all power to the circuit at the circuit breaker.**
2. Install 1" electrical conduit and glue an elbow on top to prevent water filling the conduit.
3. Feed cord through the niche and conduit to the Junction Box or 12 VAC Transformer.
 - Note:** Leave atleast 3 ft [0.9 m] of cable in the niche to allow for adjustments.
4. At the 12 VAC transformer or junction box.
 - Note:** Leave atleast 6 inches [15.2 cm] of cord in the Junction Box or transformer to ease light installation or niche inspection.
5. Cut off excess cord.
6. Carefully strip the outer cord jacket back 3 inches [7.6 cm], ensuring the insulation on the inner conductors is not damaged.
7. Carefully strip both conductors 1/2-inch [1.3 cm], ensuring the copper wires are not damaged.
8. Connect both conductors, and the ground wire, to the corresponding wires in the junction box or 12 VAC transformer. See **FIGURE 2**.
 - **BLACK to POWER (RED)**
 - **WHITE to COMMON (WHITE)**
 - **GREEN to GROUND (BONDING LUG)**
9. Route bond wire up from pedestal into the bowl.
10. Close and secure the junction box cover.
11. Prepare the end of the fire feature power cable and connect to the 12 VAC output wires of an approved transformer.
 - Note:** If the fire feature is receiving insufficient power, a 14 VAC tap on your transformer is recommended.
12. Connect a bonding wire to the bonding lug on the side of the control box.

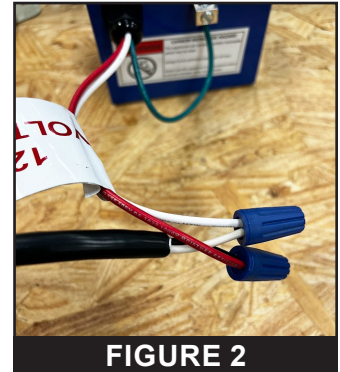

FIGURE 2

PLUMBING/WATER INSTALLATION

1. Route 1-1/2 inch PVC pipe to the bowl.
2. Reduce 1-1/2 inch plumbing to female 3/4-inch NPT.
3. Install the provided 3/4-inch barb fitting into the reducer bushing.
4. Attach the water line to the barb fitting and secure it with a band clamp.
5. Test the water connections for leaks.

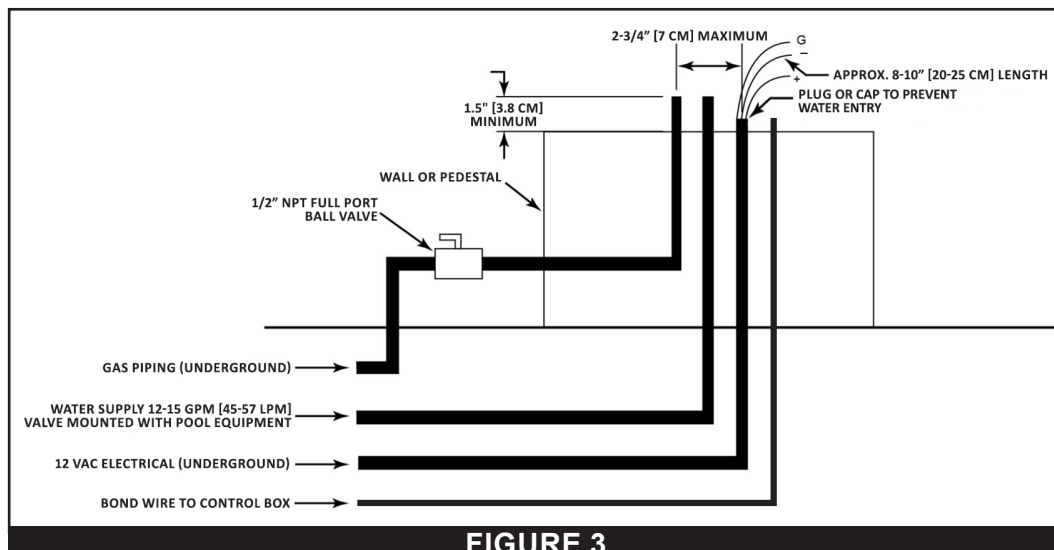

FIGURE 3

BOWL INSTALLATION

Water Bowls:

Water bowls must be leveled, centered or placed in the desired position and secured to the mounting surface. Once this is complete, the center hole must be sealed and filled in such a way that water will not leak through the water inlet pipe and onto the mounting surface.

Water bowls typically are permanently adhered to its mounting surface. Water bowls must be secured and sealed to the mounting surface using a sealing adhesive and not the mounting method described below.

Fire and Fire/Water Bowls:

Stub-outs should be centered so that the bowl can be permanently installed in the desired position. Although there is a center hole in the bowl bottom, any off centered stub-outs may require cutting the bottom of the bowl in order to fit properly onto the mounting surface.

To install the bowl:

1. Ensure the desired mounting surface is level and allows for recommended vertical and horizontal clearances.

Note: Minimum vertical clearance of 6 ft [1.8 m] above the burner. Minimum side to side clearance of 4 ft [1.2 m].
2. Place the bowl over the electrical, gas, bonding wire and water stub-outs.
3. Ensure the bowl is centered and the front edge of the bowl scupper extends into the pool or body of water by 3 inches [7.6 cm].
4. Looking down into the bowl, mark four points for feature support feet. See **FIGURE 4**.



FIGURE 4

5. Using a 3/8-inch concrete drill, drill down a minimum of 4 inches [10.2 cm] at all four marked locations. See **FIGURE 5**.



FIGURE 5

6. Install a single anchor bolt until flush with the bowl.

Note: Do not over-tighten or strip the anchor bolts.
7. **Gently ensure the bowl is tightly secured to the mounting surface and can not be rocked or lifted.**
Any offset will cause the bowl to crack when the next three anchors are being secured.
8. Repeat the anchoring process for each mounting location.
9. Ensure the bowl is firmly secured to the surface. The bowl should not tip, rock or otherwise move in any way.

⚠ DANGER FAILURE TO FOLLOW THESE INSTRUCTIONS COULD RESULT IN PROPERTY DAMAGE, PERSONAL INJURY, OR DEATH.

⚠ WARNING Be aware of the risk of high surface temperatures and stay at a safe distance to avoid burns or clothing ignition.

⚠ WARNING DO NOT allow children to play on or around the fire feature or any associated equipment.

⚠ WARNING ALWAYS closely supervise young children when around this product or pool.

⚠ WARNING DO NOT stand, sit, or hang on the fire bowl.

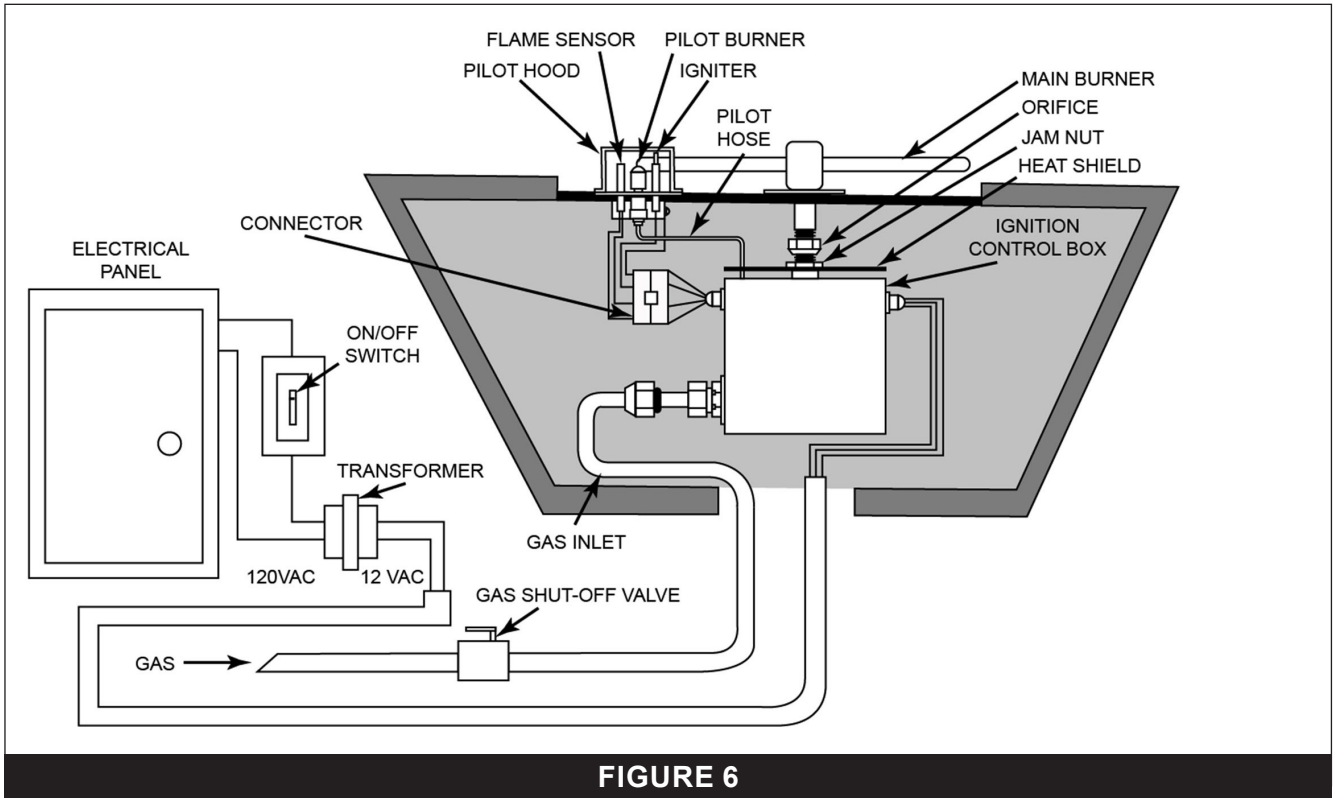

FIGURE 6

INSTALLING THE BURNER ASSEMBLY

The fire feature includes a burner assembly and control box. The burner and control box will need to be connected to the gas and electrical supply lines.

1. **Before installing the burner assembly**, ensure the correct pilot and burner orifices are installed.
 - a. **If feature will be fueled by propane gas:** Both the factory installed natural gas pilot and natural gas burner orifices must be replaced with the provided propane orifices by a qualified service professional or gas supplier.
 - b. **If feature will be installed above 4,000 ft [1,219 m] altitude:** Both the pilot and burner orifice must be replaced with the appropriate orifice.

For instructions for replacing each orifice, refer to *REPLACING THE PILOT ORIFICE*, page 17 and *REPLACING THE BURNER ORIFICE*, page 19.

2. Lift the burner assembly from the bowl. See **FIGURE 7**.

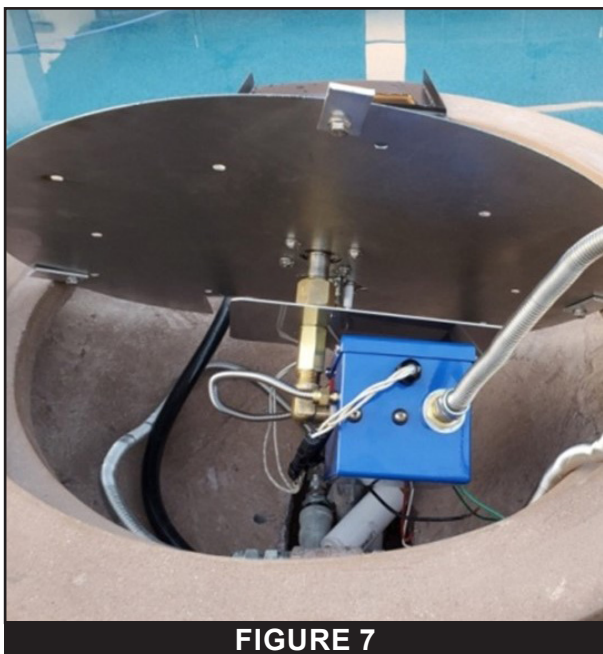

FIGURE 7



FIGURE 8

3. Connect the flexible gas hose to the inlet flare fitting from the gas supply to flare fitting on the inlet of the control box.
4. Use an adjustable wrench to tighten the hose to the fittings. Ensure they are tight and do not leak gas. See **FIGURE 8**.

Note: If this fitting is not tightened correctly it will leak and potentially ignite and can be hazardous.
5. Connect the 12 VAC and ground wires from the control box, to the 12 VAC and ground wires routed through the conduit.

Note: These wires are coming from the supply voltage transformer. Use wire nuts to connect each wire to the control in the fire feature.
6. Connect the copper bonding wire to the bonding lug on the side of the control box.
7. Turn on gas to the unit.
8. Using a gas-approved leak detection fluid or device, test for leaks at the gas fitting.
9. Lower the burner assembly into the bowl. The support plate will sit on the inner ledge of the bowl.
10. Reestablish power to the fire feature at the circuit breaker.

ADDING FIRE MEDIA



WARNING ONLY use approved fire media, correctly distributed, to ensure safety and proper combustion. Never use non-porous material, or any material that holds moisture, such as gravel, pebbles, river rock, etc.

When heated, non-porous material will not allow steam to properly vent which can result in the material fracturing and causing personal injury or property damage. When heated, materials that hold moisture can boil and fracture unexpectedly and cause personal injury or property damage.

1. Place fire media onto the support plate.

Note: Do not overfill the support plate.

2. Spread the media evenly over the support plate and burner. Depth of media should be approximately 3 inches.

Note: Ensure the burner is covered, but not buried. If using fire glass, cover the burner with a 1/4-inch to 1/2-inch of glass. See **FIGURE 9**.

Note: Do not cover the top of the pilot hood. The pilot needs air to operate properly. See **FIGURE 9**.

3. Turn the system on and ensure it lights and flames come through the fire media.
4. If fire media must be adjusted or redistributed, turn off the ignition system and wait for the media to cool.



FIGURE 9



WARNING Fire media may still be hot after the fire feature is shut off. To prevent personal injury, ALWAYS allow the fire media to cool before redistributing. Depending on the size of the bowl, cooling may take up to an hour.

OPERATION



WARNING This section contains instructions for operating the fire feature. Follow these instructions to ensure safe and proper operation. Failure to follow these instructions may result in personal injury or property damage due to burns or accumulation of fuel gas.

OPERATION GUIDELINES

- Do not operate the fire feature in rainy conditions or when fire media is wet. Doing so may cause fire media to crack and burst.
- Never use the fire feature in windy conditions.
- Do not reach/jump across or touch hot surfaces or open flames.
- Inspect the fire feature before every use.
- Before operating or testing the fire feature, ensure there are no obstructions, debris or combustible materials contacting or within proximity of it.
- Never leave the fire feature unattended when in use. Always turn off the fire feature after use.
- Never attempt to adjust the gas flow by adjusting the pressure regulator.
- It is recommended to cover the fire feature with a designated cover if it will not be operated for long periods of time.



WARNING Always allow the fire media, burner and bowl to completely cool before covering it. Failure to follow these instructions could result in property damage, personal injury, or death.

OPERATING THE FIRE FEATURE

MagicFlame can be controlled via a standard wall-mount light switch. Multiple fire features can be connected, through a junction box, to a single switch so that all fire bowls can be switched on and off together.

The fire feature can also be controlled via most Pentair automation systems. For more information refer to your specific automation system's manual.

LIGHTING THE FIRE FEATURE

1. Ensure all gas supply valve(s) are open before attempting to light the fire feature.
2. Turn on the power switch to the fire feature.
3. After 3 seconds, the igniter will begin to glow red. Shortly after this (roughly 5 seconds), the burner will ignite.
3. The igniter will remain lit 6 to 8 seconds to prove a flame is produced and will then ignite the burner. The igniter will shut off and the flame will continue as long as the flame is present and can be sensed by the pilot sensor.
4. If burner fails to light, it will attempt to light three additional times. If the burner still fails to ignite after these three attempts, it will lock out and will need to be reset by cycling the power off then on.

Note: Windy conditions or gusts may push or pull the flame away from the pilot sensor, causing the system to shut down for 7 seconds and then re-start the ignition sequence. This will continue for 5 minutes, if it cannot maintain a flame after 5 minutes the system will lock out and will need to be reset by cycling the power off then on.

Note: When lighting the burner for the first time there will be air in the gas lines that will need to be purged. This may require multiple system resets.

IMPORTANT! ALWAYS WAIT 5 MINUTES BEFORE ATTEMPTING TO RELIGHT AFTER A RESET!

4. Once the burner successfully lights and operates for at least 3 minutes, the control box will begin to monitor the flame.

MAINTENANCE

⚠ DANGER **RISK OF FIRE OR EXPLOSION!** Improper installation and/or servicing can result in flammable gas leaks, which could result in death, serious injury, or major property damage. Installation and servicing must be performed by a qualified service professional or gas supplier.

⚠ DANGER **RISK OF CARBON MONOXIDE POISONING OR ASPHYXIATION!** This product can produce carbon monoxide, a tasteless and odor-less toxic gas. Improper installation and/or servicing may lead to a build-up of carbon monoxide, which can result in death, permanent brain damage, or other serious injury. Installation and servicing must be performed by a qualified service professional or gas supplier.

NEVER install or operate this product in an enclosed space where carbon monoxide can accumulate.

GENERAL MAINTENANCE

- Inspect the fire feature before every use.
- Ensure there are no obstructions or combustible materials on or near unit before.
- It is recommended to cover the fire feature with a designated cover if it will not be operated for long periods of time.

⚠ WARNING Always allow the fire media, burner and bowl to completely cool before covering it. Failure to follow these instructions could result in property damage, personal injury, or death.

- Before operating or testing the fire feature, ensure there are no obstructions, debris or combustible materials contacting or within proximity of it.
- Ensure all connections and fittings are tight and free of damage (cracks, abrasions, leaks, etc.) annually.
- Inspect main burner for clogged burner ports or cracks annually.
- Ensure the pilot and surrounding area are free of debris or excess soot. After cleaning, turn on the unit and ensure proper ignition.
- Remove any foreign debris from the fire media when necessary.
- If servicing electrical controls, label all wires before disconnecting conductors.
- Do not alter any component or design of this unit, as it may alter operation.
- The fire feature control box is a non-serviceable item. If the control box is damaged or fails, the entire assembly must be replaced.

ANNUAL MAINTENANCE

- The fire feature should be serviced annually by a professional gas technician certified in the United States by the National Fireplace Institute (NFI). Any parts that require replacement should be replaced only by a qualified service professional using parts recommended by the original manufacturer.
- Remove and clean fire media.
- Inspect burner for clogged burner ports or cracks. If the burner is damaged it must be replaced with an identical burner supplied by the original manufacturer.
- Remove and inspect pilot to ensure no debris is caught in the pilot, the pilot sensor is not corroded and the igniter is operating properly.
- Inspect and clean components all components under the support plate.
- Inspect wiring for damage or corrosion and ensure tight connections.
- Check for gas leaks.

WINTERIZING THE FIRE FEATURE

- Turn off water, electrical and gas supplies.
- Remove all water from the water supply lines.
- Cover the fire feature with a designated cover.

⚠ WARNING Always allow the fire media, burner and bowl to completely cool before covering it. Failure to follow these instructions could result in property damage, personal injury, or death.

REPLACING THE PILOT ORIFICE

The pilot orifice is located at the base of the pilot/igniter assembly and the burner orifice is located at the end of the main burner pipe.

Each orifice is specific for either Natural Gas or Propane.

1. Turn off the electrical and gas supply to the fire feature.
2. Remove fire media from the bowl.

⚠ WARNING Fire media may still be hot after the fire feature is shut off. To prevent personal injury, ALWAYS allow the fire media to cool before redistributing. Depending on the size of the bowl, cooling may take up to an hour.

3. Remove the two mounting screws securing the pilot/igniter assembly to the support plate. See **FIGURE 10**.
4. Lift the burner assembly from the bowl and turn it over to access the underside components.
5. Unplug the connector from the control box. See **FIGURE 11**.
6. Disconnect the flexible pilot gas hose from the control box. See **FIGURE 12**.
7. From the top of the burner support plate, pull up and remove the pilot/igniter assembly. See **FIGURE 13**.
8. Remove the Flare Fitting from the Pilot Orifice and remove the Pilot Orifice from the support bracket. See **FIGURE 14**.
9. Install the new Pilot Orifice in reverse order.

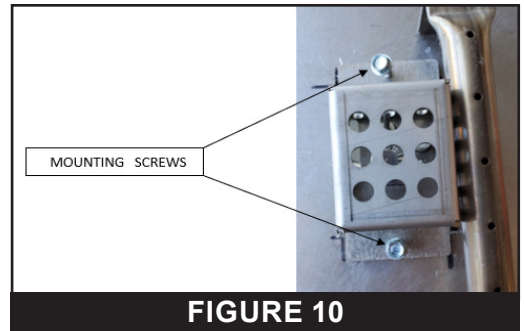

FIGURE 10



FIGURE 11

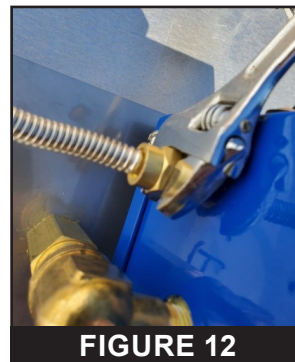

FIGURE 12



FIGURE 13

REPLACING THE IGNITER

1. Turn off the electrical and gas supply to the fire feature.
2. Remove fire media from the bowl.

⚠ WARNING Fire media may still be hot after the fire feature is shut off. To prevent personal injury, ALWAYS allow the fire media to cool before redistributing. Depending on the size of the bowl, cooling may take up to an hour.

3. Remove the two mounting screws securing the pilot/igniter assembly to the support plate. See **FIGURE 10**.
4. Lift the pilot/igniter assembly and expose the connector.
5. Unplug the connector from the control box. See **FIGURE 11**.
6. Remove the pilot hood. See **FIGURE 14**.
7. Remove the mounting screw securing the igniter and remove the damaged igniter. See **FIGURE 15**.
8. Mount the new igniter assembly to the support plate, ensuring the slotted side of the pilot hood is facing the burner. See **FIGURE 13**.

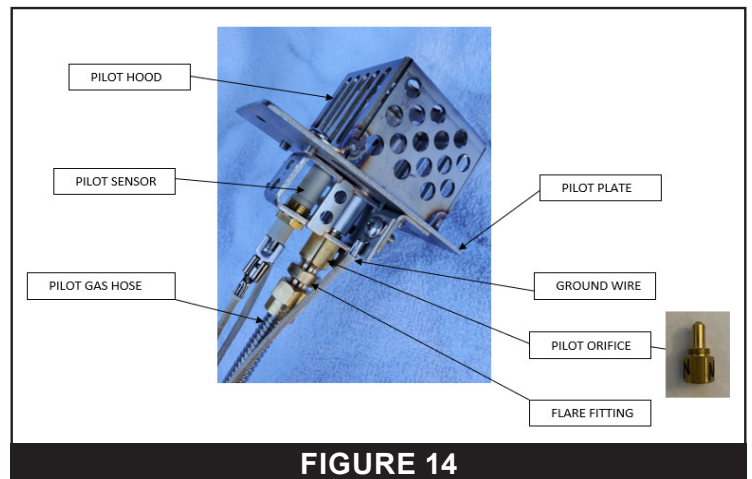

FIGURE 14

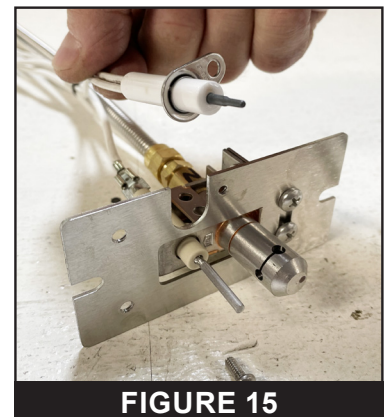

FIGURE 15

REPLACING THE PILOT/IGNITER ASSEMBLY

1. Turn off the electrical and gas supply to the fire feature.
2. Remove fire media from the bowl.

⚠ WARNING Fire media may still be hot after the fire feature is shut off. To prevent personal injury, ALWAYS allow the fire media to cool before redistributing. Depending on the size of the bowl, cooling may take up to an hour.

3. Remove the two mounting screws securing the pilot/igniter assembly to the support plate. See **FIGURE 16**.
4. Lift the burner assembly from the bowl and turn it over to access the underside components.
5. Unplug the connector from the control box. See **FIGURE 17**.
6. Disconnect the flexible pilot gas hose from the control box. See **FIGURE 18**.
7. From the top of the support plate, pull up and remove the old pilot/igniter assembly. See **FIGURE 19**.
8. Insert the new pilot/igniter assembly through the top of the support plate, ensuring the slotted side of the pilot hood is facing the burner. See **FIGURE 19**.
9. Align the pilot hood and support plate mounting points and secure the pilot/igniter assembly to the support plate with the two mounting screws. See **FIGURE 16**.
10. Flip the support plate to access the underside components.
11. Connect the pilot/igniter assembly connector to the control box connector. See **FIGURE 17**.

Note: To ensure a watertight connection, ensure the connector snaps together.

12. Take the flexible stainless steel pilot hose and connect it to the control box fitting. Secure with wrench but be careful not to over-tighten as it may damage the brass thread. See **FIGURE 18**.
13. Place the burner assembly back into the bowl.
14. Turn on gas to the unit.
15. Ignite the fire feature and test to make sure the system lights.
16. If test is successful, turn off fire feature and wait for it to cool.

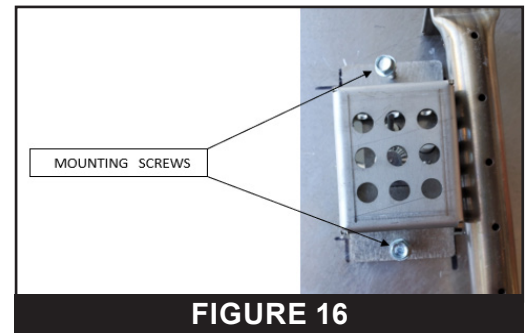

FIGURE 16



FIGURE 17

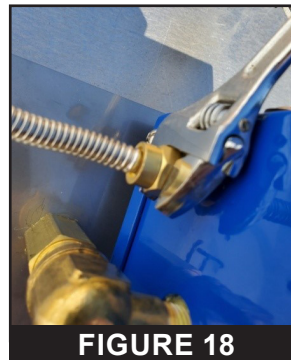

FIGURE 18

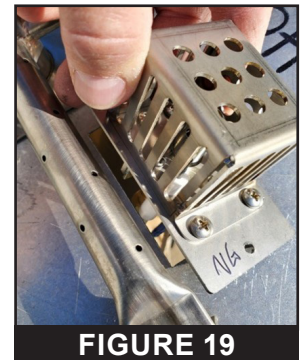

FIGURE 19

REPLACING THE BURNER ORIFICE

If your fire feature will be fueled by propane, the factory-installed burner orifice must be removed and the provided propane orifice must be installed.

After installing the propane orifice, the label on the bottom of the control box must be updated to indicate the fire feature has been set up to use propane gas.



RISK OF FIRE OR EXPLOSION FROM INCORRECT FUEL USE OR FAULTY FUEL CONVERSION! DO NOT ATTEMPT TO OPERATE A FIRE FEATURE SET UP FOR NATURAL GAS ON PROPANE OR VICE VERSA. SERIOUS MALFUNCTION OF THE BURNER CAN OCCUR WHICH MAY RESULT IN DEATH.

Only a qualified service professional or gas supplier should attempt to convert from one fuel to the other. If it is necessary to convert to a different type of gas, consult your Pentair dealer.

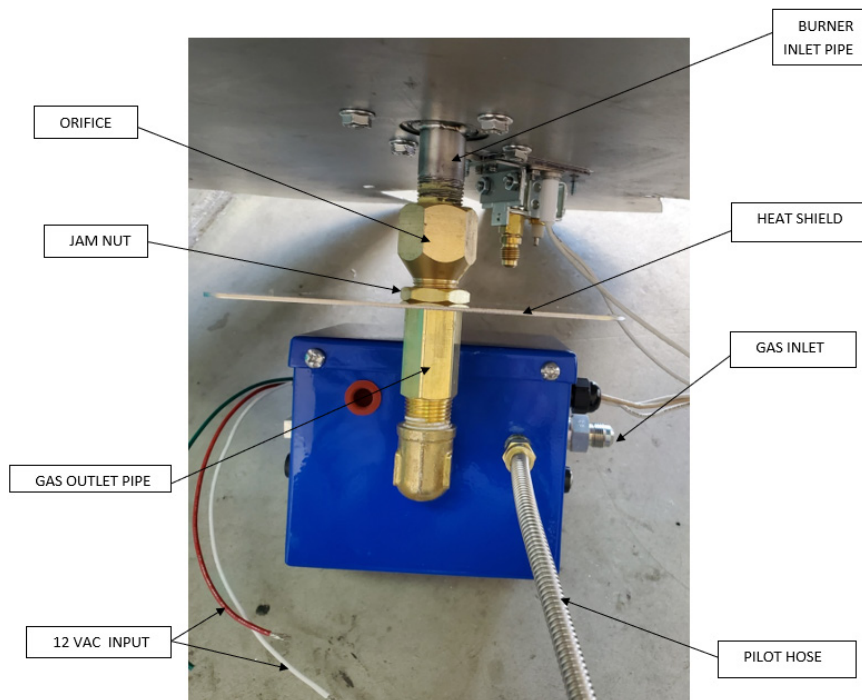

1. Secure the support plate.
2. Ensure the pilot/igniter assembly has been disconnected and removed. Refer to *REPLACING THE PILOT/IGNITER ASSEMBLY*, page 18 for instructions.
3. Place an adjustable wrench on the burner orifice and rotate the control box counter-clockwise until the control box separates from the burner inlet pipe.
4. Place the control box on a flat surface and hold it in position.
5. Using an adjustable wrench, loosen the jam nut.
6. Remove the burner orifice from the gas outlet pipe.

Note: Once the burner orifice is removed, the heat shield is no longer secured to the control box.
7. Remove the jam nut from the old orifice. See **FIGURE 20**.
8. Thread the jam nut onto the new orifice until it can no longer be turned. See **FIGURE 21**.
9. Apply thread sealant to the new orifice threads ensuring the last three threads are covered well.
10. Place the heat shield over the gas outlet pipe and begin threading the orifice into place.
11. Tighten the orifice until secure. See **FIGURE 21**.

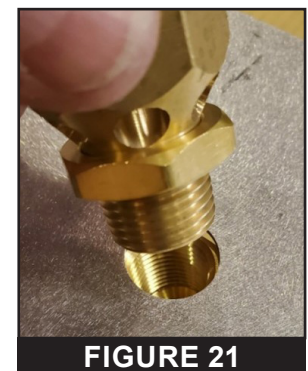

- CONTINUE TO NEXT PAGE -

REPLACING THE BURNER ORIFICE (CONT.)

12. Position the heat shield and tighten the jam nut by hand until it holds the heat shield in place.
13. Using a wrench, tighten the jam nut until the heat shield is firmly secured.
14. Apply pipe thread sealer onto the burner inlet pipe. See **FIGURE 22**.
15. Thread the control box outlet onto the burner inlet pipe and clockwise until tight. See **FIGURE 23**.
Note: Ensure the heat shield is not blocking the pilot hole. See **FIGURE 24**.
16. Update the label on the bottom of the control box to indicate the fire feature has been converted to operate on propane gas.



FIGURE 22



FIGURE 23

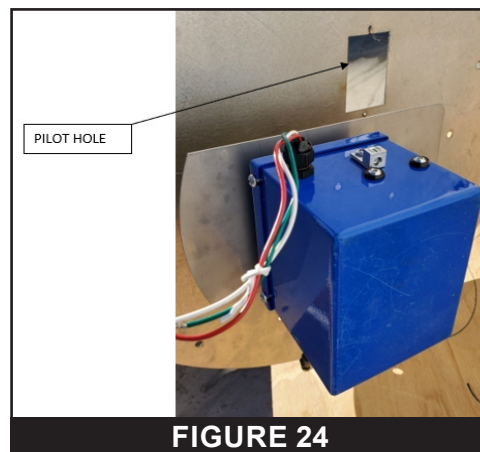

FIGURE 24

REPLACING THE PILOT SENSOR

1. Turn off the electrical and gas supply to the fire feature.
2. Remove fire media from the bowl.

WARNING Fire media may still be hot after the fire feature is shut off. To prevent personal injury, ALWAYS allow the fire media to cool before redistributing. Depending on the size of the bowl, cooling may take up to an hour.

3. Remove the two mounting screws securing the pilot/igniter assembly to the support plate. See **FIGURE 25**.
4. Lift the pilot/igniter assembly and expose the connector.
5. Unplug the connector from the control box.
6. Remove the pilot hood.
7. Remove ground wire from the sensor assembly. See **FIGURE 27**.
8. Remove brass nut securing the sensor to bottom of pilot plate. See **FIGURE 28**.
9. Remove the damaged sensor. See **FIGURE 28**.
10. Install the new pilot sensor.
11. Insert the new pilot/igniter assembly through the top of the support plate, ensuring the slotted side of the pilot hood is facing the burner. See **FIGURE 26**.
12. Secure the pilot/igniter assembly to the support plate with the two mounting screws. See **FIGURE 25**.

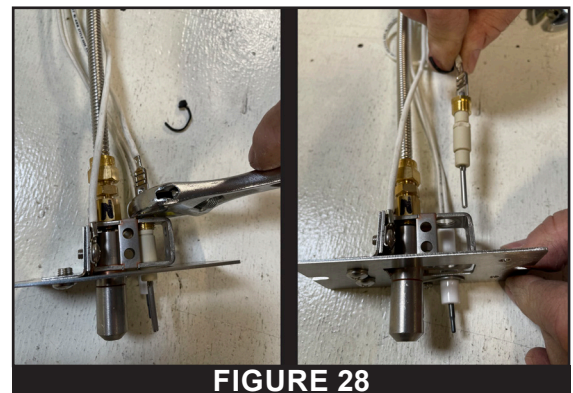
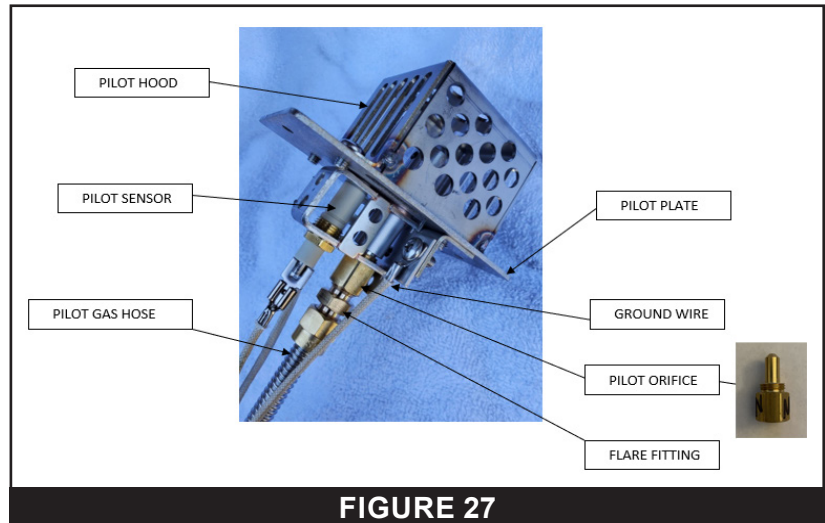
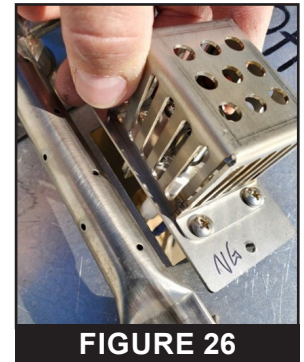
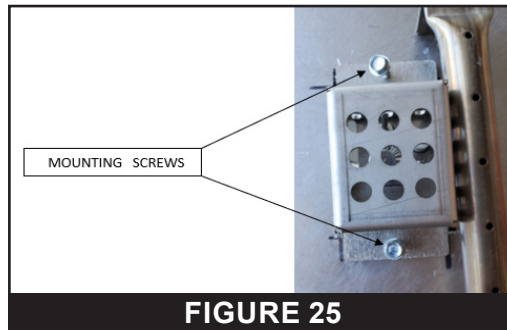

TROUBLESHOOTING

⚠ DANGER	RISK OF FIRE OR EXPLOSION! Improper servicing can result in flammable gas leaks, which could result in death, serious injury, or major property damage. All servicing must be performed by a qualified service professional or gas supplier.
⚠ DANGER	RISK OF CARBON MONOXIDE POISONING OR ASPHYXIATION! This product can produce carbon monoxide, a tasteless and odor-less toxic gas. Improper servicing may lead to a build-up of carbon monoxide, which can result in death, permanent brain damage, or other serious injury. All servicing must be performed by a qualified service professional or gas supplier.

If experiencing trouble with the fire feature, contact a qualified service professional to check the following:

Problem	Possible Cause/Solution
Fire feature fails to ignite	Circuit breaker may be tripped or turned off.
	Ensure the transformer is delivering 12 VAC power.
	Inspect electrical wiring for cuts or other damage.
	Ensure the gas supply shut-off valve is open.
	Ensure igniter glows red when switched on. <ul style="list-style-type: none"> • If the igniter does NOT glow red; Igniter may require replacement. Contact a qualified service professional. • If igniter does glow red but does not light the pilot burner; Orifice(s) may be clogged or obstructed and require cleaning or replacement. Contact a qualified service professional.
Pilot flame ignites, but main burner does not	Control box requires servicing. Contact a qualified service professional.
Fire feature turns on but shuts off after a few seconds	Ground connection may be faulty. Ensure there is a proper ground connection to pilot burner. Verify proper gas pressure.
Orifices are clean but fire feature still does not receive gas	Gas supply may be obstructed by water or other debris. The supply line should be vacuumed out to clear the obstruction.
Fire feature operates sporadically or turns off unexpectedly	Fire feature may be overheating. Ensure that the support plate and burner are not overfilled with fire media.
	Ensure lower vents are clear of fire media/debris.
	Fire feature may be shutting down due to high wind pressure.

REPLACEMENT PARTS

ITEM	P/N	DESCRIPTION
1	590293	Spillway (Square, Water Only)
	590294	Spillway (Round, Water Only)
	590295	Spillway (Square, Fire/Water)
	590296	Spillway (Round, Fire/Water)
2	590283	Burner
3	590303	Pilot Hood
4	590301	Support Plate (Square, Fire Only)
	590302	Support Plate (Round, Fire Only)
	590292	Support Plate (Square, Fire/Water)
	590284	Support Plate (Round, Fire/Water)
5	See next page	Burner Orifice
6	590286	Jam Nut
7	590279	Pilot Orifice, Propane
	590281	Pilot Orifice, Natural Gas
8	590305	Flare Fitting
9	590287	Pilot Hose
10	590276	Igniter
11	590277	Flame Sensor
12	590285	Heat Shield
13	590278	Control Box
14	590288	Burner Hose w/ Flare Fitting
15	See next page	Bowl
16	590334	Burner Assembly (Round, Fire Only)
	590335	Burner Assembly (Square, Fire Only)
	590336	Burner Assembly (Round, Fire/Water)
	590337	Burner Assembly (Square, Fire/Water)
17	590324	Waterline Assembly
-	590275	Pilot/Igniter Assembly (includes items 3, 10 and 11)
-	See next page	Paint Repair Kit
-	See next page	Fire Media
-	590289	Winterizing Cover, Round
	590290	Winterizing Cover, Square
-	590291	Mounting Hardware Kit

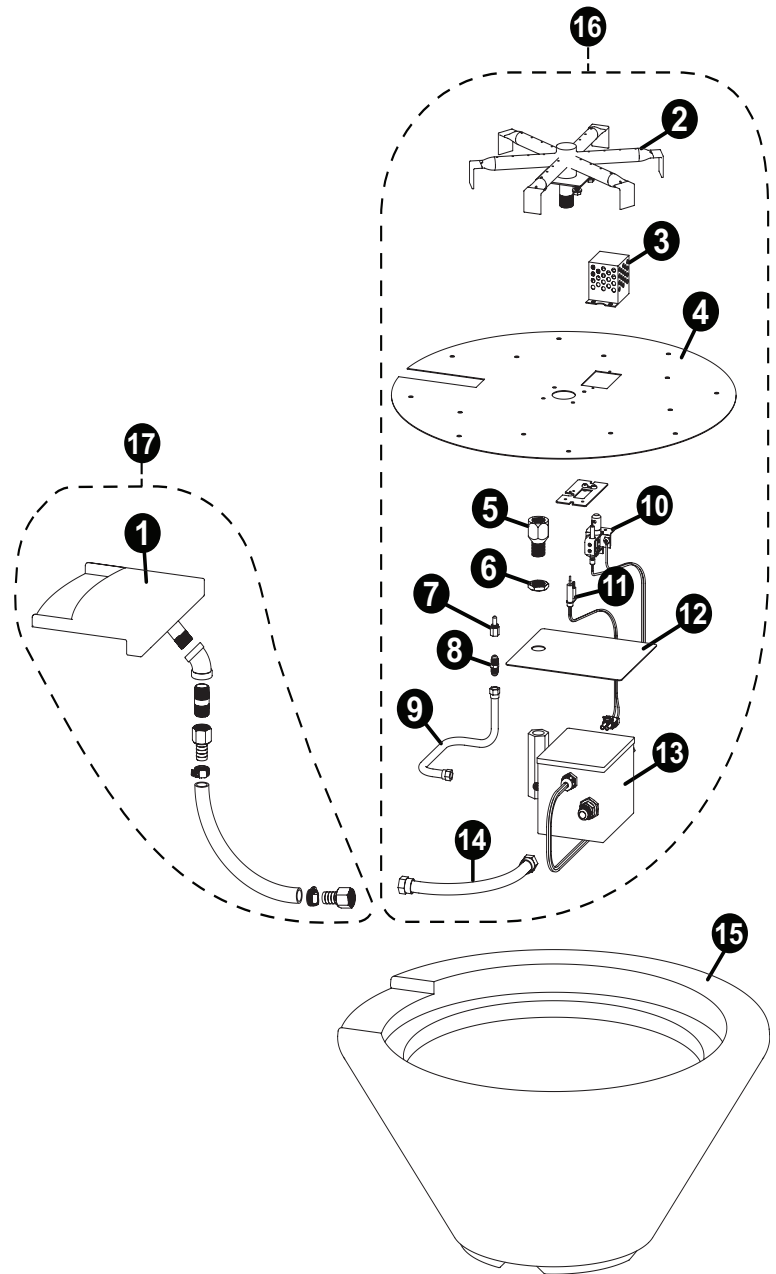

Note: Round fire/water feature shown above. Fire only or water only models do not contain some components.

REPLACEMENT BURNER ORIFICES (ITEM #5)

INSTALL ELEVATION	PROPANE	NATURAL GAS
<4000 ft. [<1219 m]	590280	590282
4000 – 6000 ft. [1219 – 1829 m]	590318	590321
6000 – 8000 ft. [1829 – 2438 m]	590319	590322
8000 – 10000 ft. [2438 – 3048 m]	590320	590323

REPLACEMENT BOWLS (ITEM #15)

FIRE/WATER BOWLS		FIRE ONLY BOWLS	
Bronze, Round	580205	Bronze, Round	580195
Pewter, Round	580206	Pewter, Round	580196
Natural, Round	580207	Natural, Round	580197
White, Round	580208	White, Round	580198
Black, Round	580209	Black, Round	580199
Bronze, Square	580210	Bronze, Square	580200
Pewter, Square	580211	Pewter, Square	580201
Natural, Square	580212	Natural, Square	580202
White, Square	580213	White, Square	580203
Black, Square	580214	Black, Square	580204

PAINT REPAIR KITS

COLOR	KIT P/N
Bronze	590307
Pewter	590308
Natural	590309
White	590310
Black	590311

FIRE MEDIA OPTIONS

MEDIA TYPE	P/N
Lava Rock, 3/4"	590267
Lava Rock, Tumbled	590268
Fire Glass, Black	590269
Fire Glass, Clear	590270
Fire Glass, Brown	590271
Fire Glass, Dark Blue	590272
Fire Glass, Light Blue	590273
Fire Glass, Gold	590274

Digital copies of all MagicFlame manuals can be found at www.pentair.com, or by scanning the provided QR code.

Se pueden encontrar copias digitales de todos los manuales de MagicFlame en www.pentair.com, o escaneando el código QR proporcionado.

Des copies numériques de tous les manuels MagicFlame peuvent être trouvées sur www.pentair.com, ou en scannant le code QR fourni.



1620 HAWKINS AVE., SANFORD, NC 27330 • (919) 566-8000
10951 WEST LOS ANGELES AVE., MOORPARK, CA 93021 • (805) 553-5000

All indicated Pentair trademarks and logos are property of Pentair. Third party registered and unregistered trademarks and logos are the property of their respective owners.

© 2023 Pentair. All rights reserved. WWW.PENTAIR.COM



P/N 590306 REV. A 5/26/23