

Robotic Pool Cleaner Classic2/Top 2

EN

Operating Instructionsp. 1-7

FR

Instructions d'opérationp. 8-14

IT

Istruzioni per l'usop. 15-21

ES

Instrucciones de usop. 22-28

DE

Bedienungsanleitungs. 29-35

PT

Instruções de operaçãop. 36-42



EN

Robot Pool Cleaner Classic2/Top2

Operating Instructions

Contents

1. SPECIFICATIONS	2
2. WARNINGS AND CAUTIONS.....	2
2.1. Warnings	2
2.2. Cautions	2
3. POOL CLEANER PARTS.....	3
4. USING THE POOL CLEANER.....	4
4.1. Set up	4
4.2. Putting the Pool Cleaner into the pool	5
4.3. Removing the Pool Cleaner from the pool	5
4.4. Maintenance	6
4.5. Off-season storage.....	7
CADDY ASSEMBLY	43

Robot Pool Cleaner Classic2/Top2

Operating Instructions

1. SPECIFICATIONS

Motor protection: IP 68

Minimum depth: 0.80m/2.6ft

Maximum depth: 5m/16.4ft

2. WARNINGS AND CAUTIONS

2.1. Warnings



- Use the originally supplied power supply only
- Ensure the electrical outlet is protected by a ground fault interrupter (GFI) or an earth leakage interrupter (ELI)
- Keep the power supply out of standing water
- Position the power supply at least 3m/10ft away from the edge of the pool
- Do not enter the pool while the pool cleaner is working
- Unplug the power supply before servicing

2.2. Cautions

When not in use store the Pool Cleaner on the Caddy in a shaded area.

Use the Pool Cleaner in the following water conditions only:

Chlorine	Max 4 ppm
pH	7.0 - 7.8
Temperature	6-34°C/43-93°F
NaCl	Maximum = 5000 ppm

3. POOL CLEANER PARTS

▶ Robot Pool Cleaner Model Classic 2

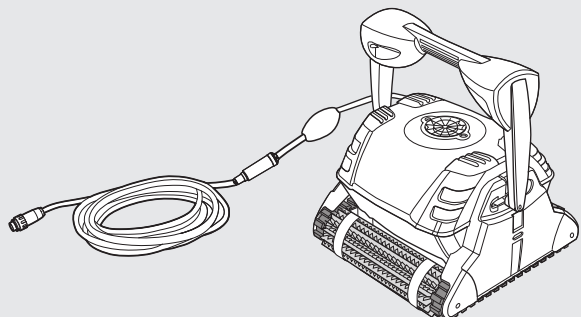

▶ Robot Pool Cleaner Model Top 2

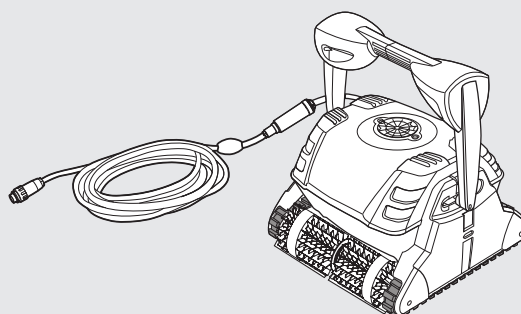

▶ Brushes

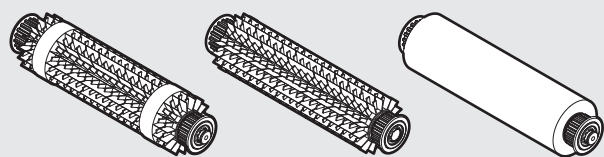

Combined Brush
All surface climbing brush, ideal for most pool surfaces.

PVC Brush
For concrete, PVC, fiberglass and liner.

Wonder (foam) Brush
For smooth ceramic tiles.

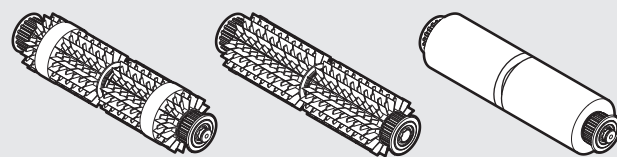

Combined Brush
All surface climbing brush, ideal for most pool surfaces.

PVC Brush
For concrete, PVC, fiberglass and liner.

Wonder (foam) Brush
For smooth ceramic tiles.

▶ Power supply unit

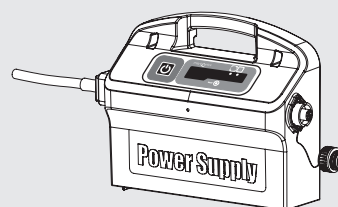
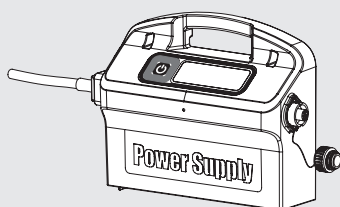

▶ Filtration

Bottom lid and filter Bag

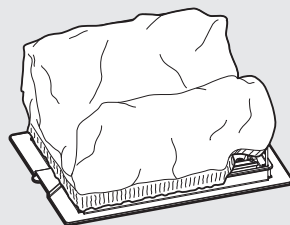

▶ Caddy Kit

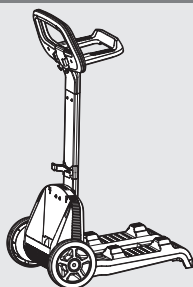

4. USING THE POOL CLEANER

4.1. Set Up

Before using the Pool Cleaner for the first time perform the following steps.

Unwind the cable and stretch it out completely so that it has no kinks.

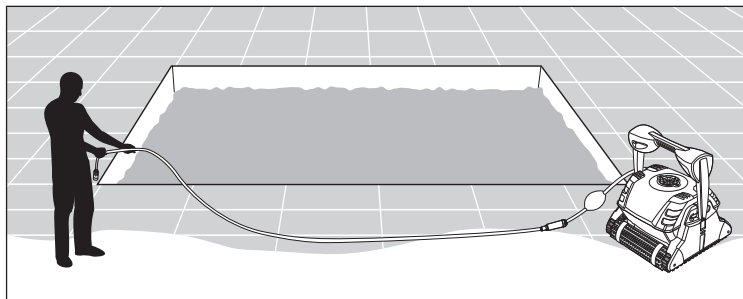
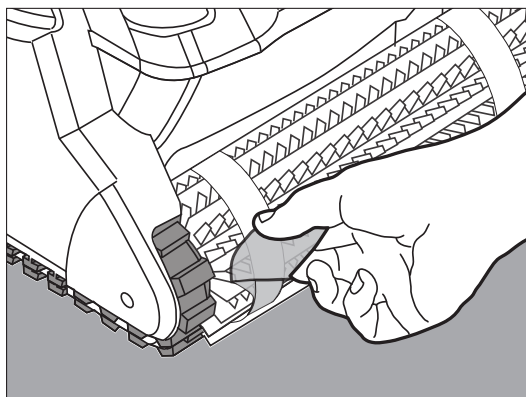

Remove the plastic coverings before use.

Position the power supply so that it is approximately in the middle of the long side of the pool at a distance of 3m/10ft.

Attach the floating cable to the power supply by inserting it with the notch on the connector (1) lined up with the groove in the socket on the power supply and turning clockwise (2).

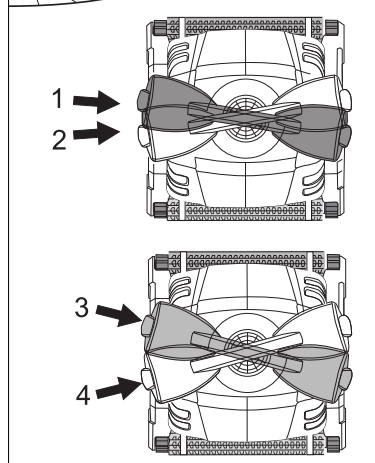
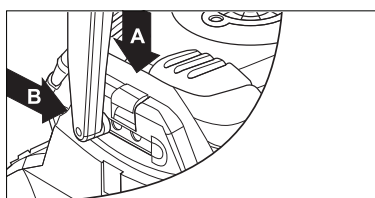
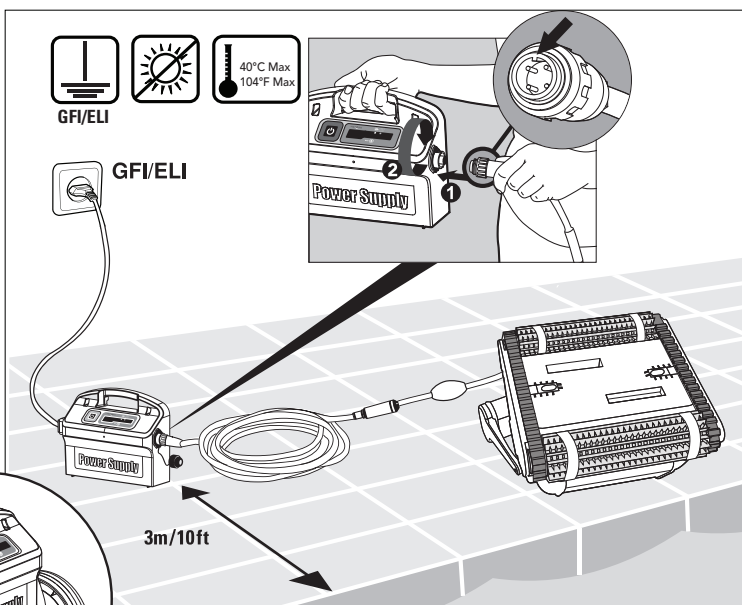

Change diagonal handle position for water line sideways movement. To adjust the handle angle:

- A.** Press the latch down and hold it in position.
- B.** Move the handle to the desired position and release the latch to hold the handle in place.

1,2: Normal advance
More efficient cleaning action on water-line.

3,4: Fast advance
Fast speed – for faster but less efficient cleaning action on water-line.

4.2. Putting the Pool Cleaner into the pool

If the foam climbing rings on the brushes are dry soak them in water until soft.

Shake the robot from side to side or turn it upside down to release trapped air.
Let it sink to the pool floor.

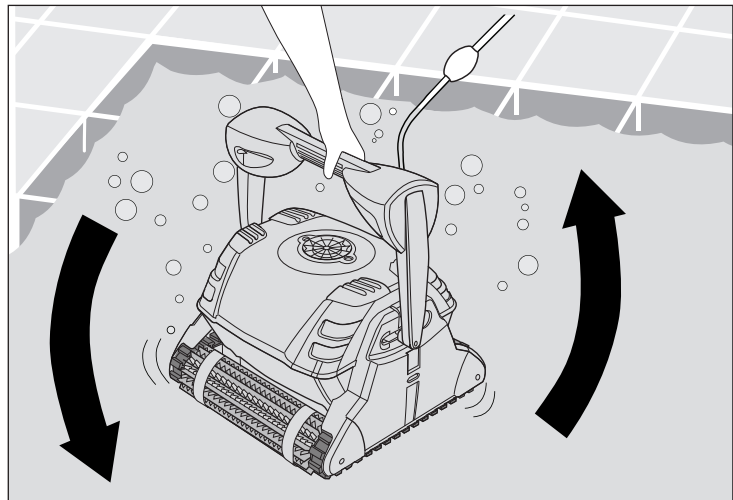

Turn the power supply ON.

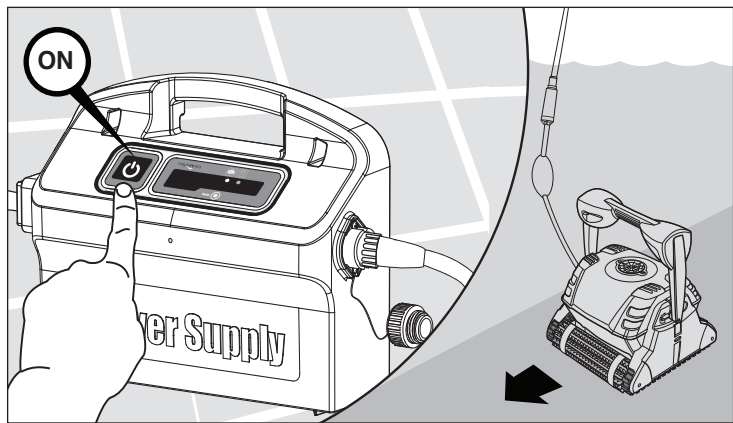

4.3. Removing the Pool Cleaner from the pool

The robot will perform automatic shut-off at the end of the cleaning cycle.

 Turn off and unplug the power supply.

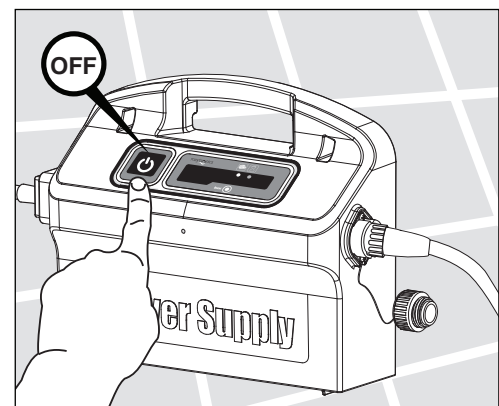

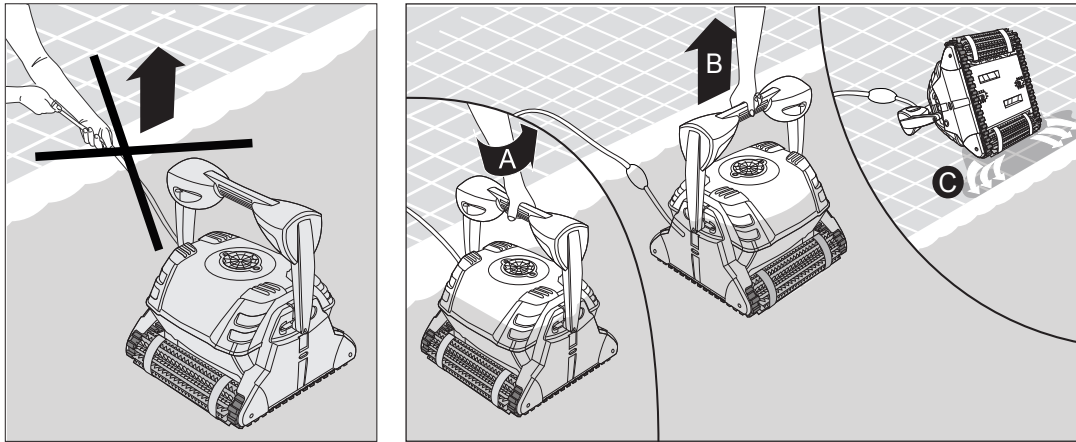

Using the floating cable, bring the Pool Cleaner to the pool's edge.

 DO NOT PULL THE POOL CLEANER FROM THE POOL USING THE CABLE.

4.4. Maintenance

Clean the filter bag with a hose.
Periodically clean the brushes with a hose. It is recommended to periodically wash the filter bag in a washing machine. Use gentle cycle program.

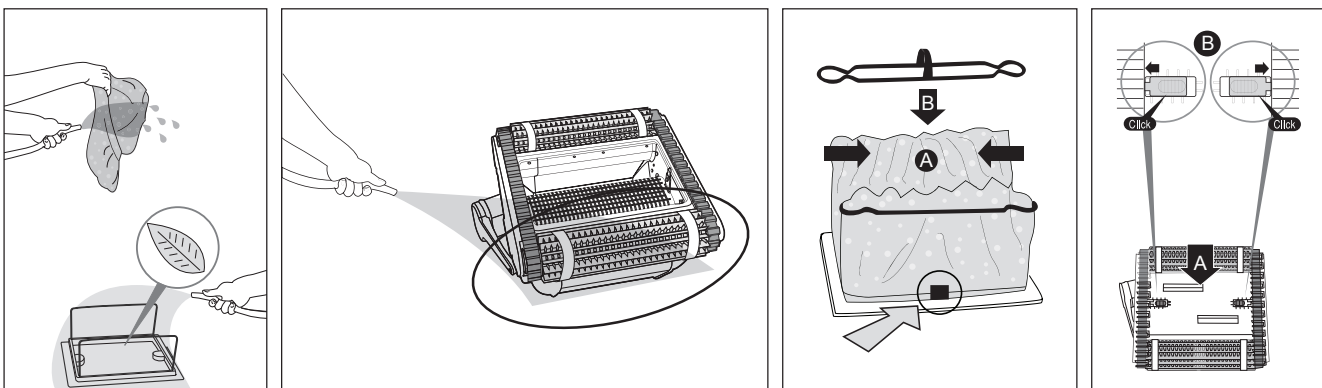
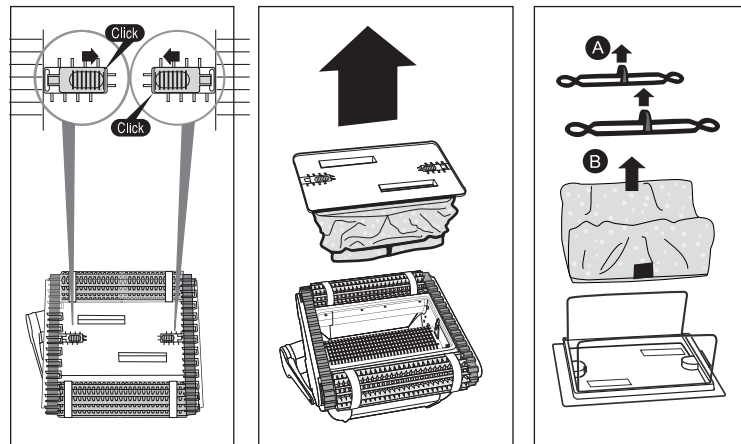

Cleaning the impeller

 Unplug the power supply.

If you notice debris trapped in the impeller open the impeller and remove the debris.

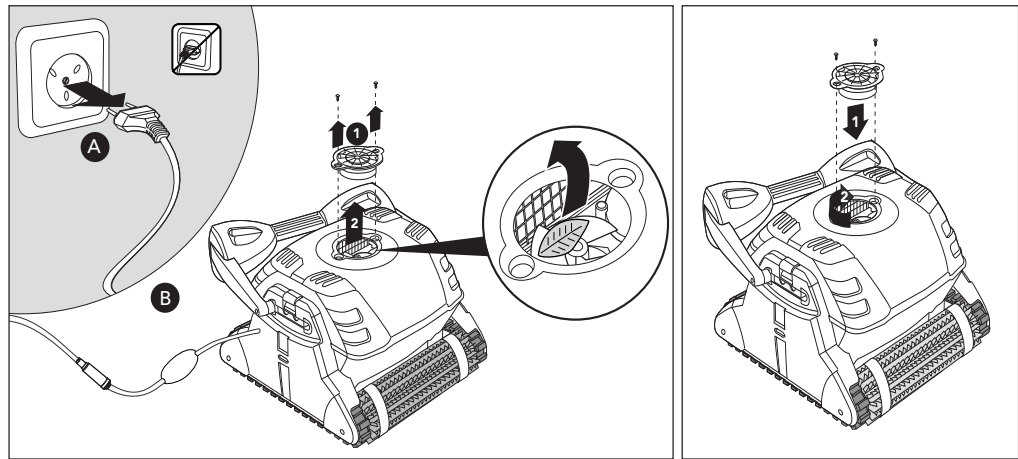

Cable

To remove the kinks, stretch the cable out completely and let it sit for at least a day in the sun.

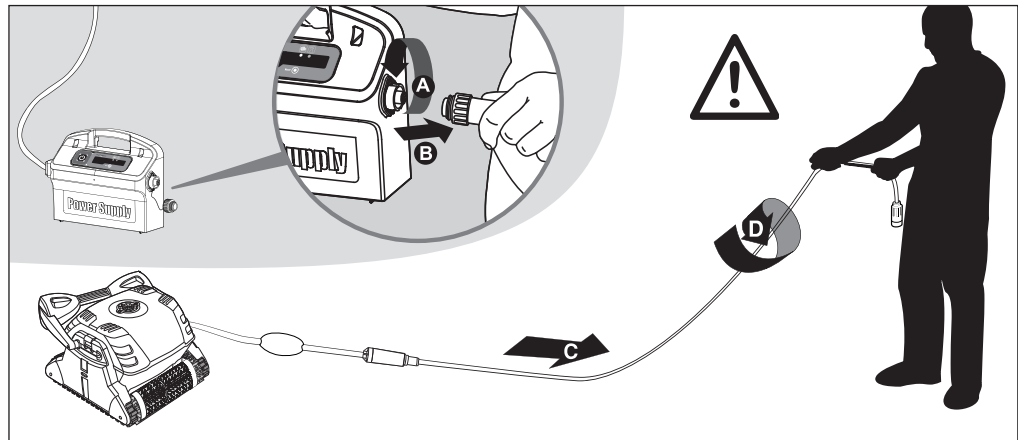

4.5. Off-season storage

If the pool cleaner will not be in use for an extended period, perform the following storage steps:

- Make sure that no water is left in the pool cleaner
- Thoroughly clean the filter bag and insert in place
- Roll up the cable so that it has no kinks and place on the Caddy
- Store the pool cleaner in a protected area either on its Caddy or simply upsidedown

