

EN Operating Instructions

Robot Pool Cleaner MTC5

English 1-14

FR Instructions d'opération

Robot nettoyeur de piscine MTC5

Français 15-29

ES Instrucciones operativas

Limpiador de piscinas Robot MTC5

Español 30-44

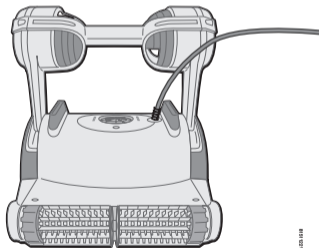

Operating Instructions 1-14

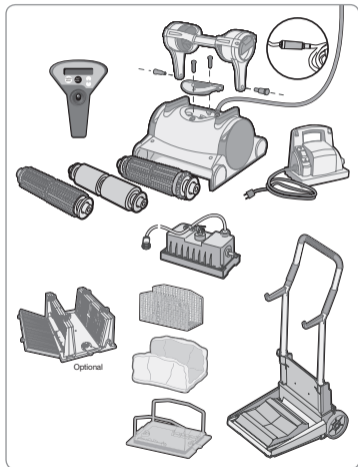

Important safety instructions



GFI/ELI

1

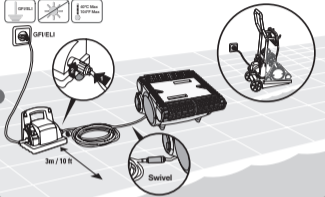

Standard Brush



Combined Brush



Wonder Brush

2

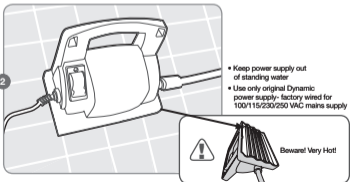



Caddy Assembly

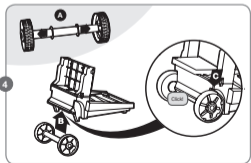
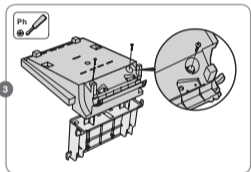

Enderezar el cable de vez en cuando

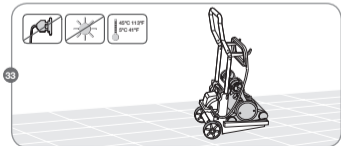
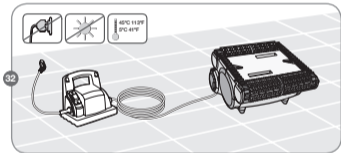
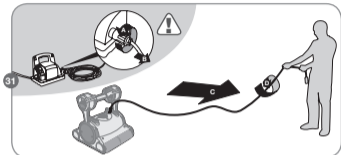

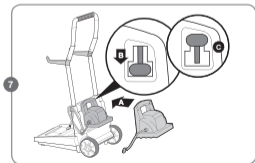
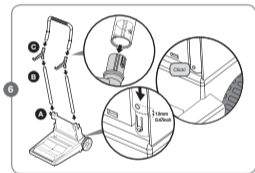
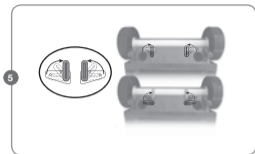
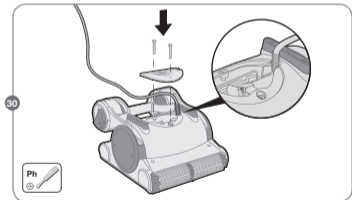
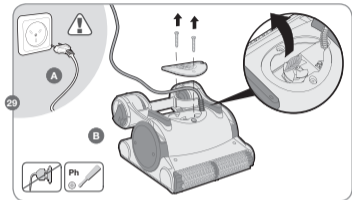

Place cable on the right side in front of the handle.
Right float faces up. Left float faces down.

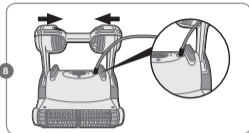

Shake robot from side to side or turn it upside down to release trapped air

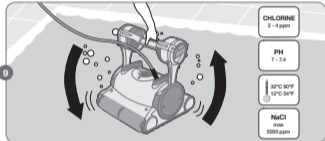

Soak and squeeze PVA (Wonder brush) / PVA rings (Combined brush) in water

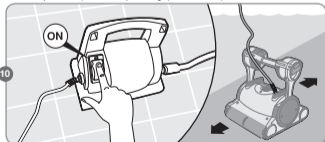

Cartridge
Optional

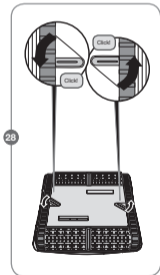
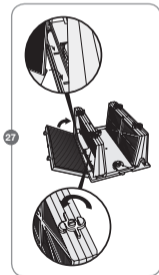
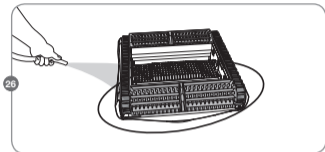

Se recomienda lavar el cartucho después de cada ciclo
 Note: en piscinas extremadamente sucias (por ejemplo, durante la limpieza de la primavera), hay que abrir y limpiar el cartucho cada 1/2 hora de operación. De lo contrario, la exploración será deficiente y el robot no preparará por las paredes de la piscina.

Cartridge Optional



Although the robot will perform automatic shut-off at the end of the cleaning cycle, switch power supply "OFF" manually

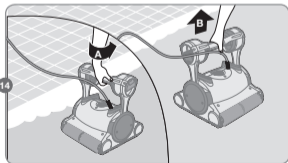
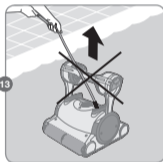
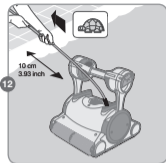
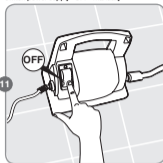
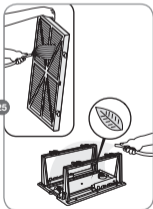
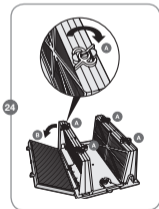
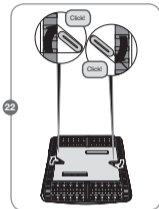



Remote Control Unit (RCU)

These buttons are used for switching between menus and options.



This button is used to switch on the RCU, to select a required menu, to SEND or to SET a parameter or a program.



This button is used to EXIT from a menu or move back a step. This button is also used to turn off the RCU. Press EXIT a number of times until RCU turns off.



If a parameter was modified, then just before final EXIT you may be required to send your new set of parameters.

Description and use of menus

Cleaning programs

- **REGULAR** – Floor and walls cleaning program.
- **ULTRAClean** – Slower movement for special thorough cleaning. Note: ULTRAClean mode can only be selected from REGULAR mode.
- **WATERline** – For special attention to walls and water line. If you choose WATERline or ULTRAClean modes, these parameters will not remain in the robot pool cleaner memory for the next cycle. Instead, the robot pool cleaner automatically switches to REGULAR mode.
- **LAPpool** – Suitable for this specific type of pool – narrow and long. Note: If you choose a LAPpool cleaning mode, set the pool length after setting this mode.

Parameters

- **CYCLE-TIME** – Choose the most suitable cycle time.
- **POOL-LENGTH** – Program the pool length.
- **CLIMB-EVERY** – This option controls the frequency of wall climbing e.g.: at which frequency the robot pool cleaner should climb on the walls.

Battery Replacement

If the message "Low Battery" appears on the RCU screen:

- Open the battery cover.
- Remove all used batteries from the RCU.
- Place two 1.5 V AAA batteries into the RCU as shown in the drawing inside the battery housing.
- Close the battery cover.

If you are not using your RCU for more than 6 months - remove batteries.

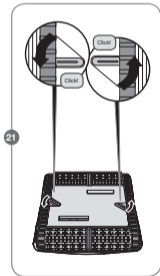
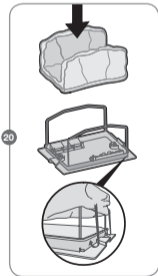
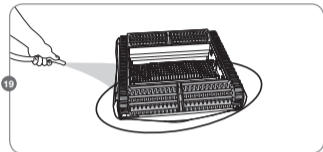

Filter Bag



Se recomienda lavar periódicamente la bolsa del filtro en una máquina lavadora.
Utilice el programa para el lavado de fibras sintéticas.

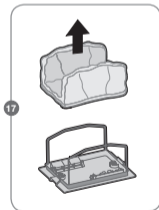
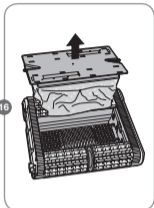
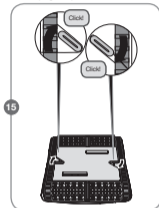

RCU

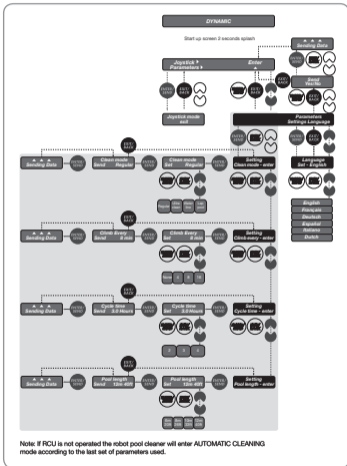

Filter Bag



RCU



It is recommended to periodically wash filter bag in a washing machine.
Use synthetic cleaning program

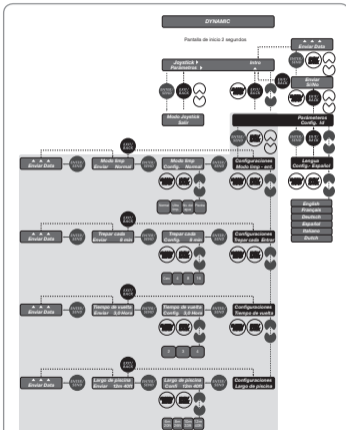
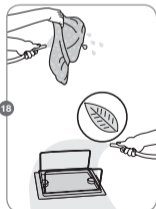
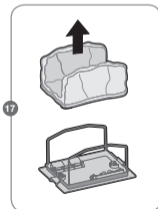
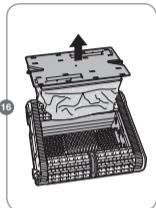
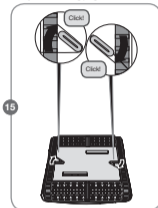

Note: si no se acciona la RCU, el limpiador de piscinas entrará en el modo LIMPIEZA AUTOMÁTICA de acuerdo con los últimos parámetros de configuración utilizados.



Unidad de control remoto (RCU)

Estos botones se usan para cambiar de un menú y de una opción a otra.



ENTER/SEND

ENTER/SEND (INGRESAR/ ENVIAR): Este botón se usa para encender la RCU, para seleccionar un menú requerido, para enviar o configurar un parámetro o un programa.

EXIT/BACK

EXIT/BACK (SALIR/ ATRÁS): Este botón se usa para salir de un menú o volver un paso atrás. También se usa para apagar la RCU. Oprima Exit (Salir) varias veces hasta que la RCU se apague.

Si se modificó un parámetro, antes de salir definitivamente puede requerirse que envíe su nuevo conjunto de parámetros.



Descripción y uso de los menús

Programas de limpieza

- **REGULAR:** programa de limpieza de piso y paredes.
- **ULTRAClean:** movimiento más lento, para una limpieza especial y más profunda.
Nota: El modo ULTRAClean sólo puede seleccionarse desde el modo REGULAR.
- **WATERLINE** (Nivel de la superficie del agua): presta especial atención a las paredes y a la superficie del agua.
Si usted elige los modos nivel de la superficie del agua o ULTRAClean, estos parámetros no quedarán en la memoria del limpiador de piscinas para el siguiente ciclo. En cambio, pasará automáticamente al modo REGULAR.
- **LAPpool** (Piscina de entrenamiento): adecuado para este tipo específico de piscinas, que son anchas y largas.
Nota: Si elige el modo de limpieza LAPpool, configure el largo de la piscina después de configurar este modo.

Parámetros

- **TIEMPO DEL CICLO:** elija el tiempo del ciclo que le resulte más conveniente.
- **LARGO DE LA PISCINA:** programe el largo de la piscina.
- **CLIMB-EVERY (TREPAR CADA):** esta opción controla la frecuencia de trepado por las paredes, por ejemplo, a qué frecuencia el limpiador de piscinas debe trepar por las paredes.

Cambio de baterías de la RCU

Si aparece el mensaje "Low Battery" en el visor de la RCU:

- Abra la tapa de las baterías.
- Quite todas las baterías usadas de la RCU.
- Coloque dos baterías de 1,5 V AAA en la RCU, como se muestra en el dibujo que está dentro del compartimiento para las baterías.
- Cierre la tapa de las baterías.

Si usted no va a usar su Unidad de control remoto durante más de 6 meses, retire las baterías.

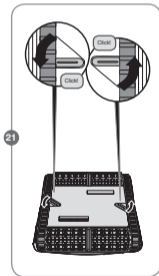
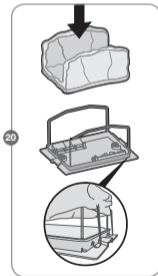
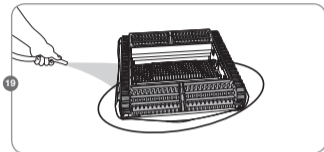

It is recommended to wash the cartridge after every cycle
Note: In extremely dirty pools (e.g. spring cleaning), there is a need to open and clean the cartridge every 1/2 hr. of operation. Failing to clean the cartridge will result in poor scanning and inability to climb the pool walls.

Cartridge Optional



Aunque el robot efectuará el apagado automático al término del ciclo de limpieza, apague la fuente de alimentación ("OFF") automáticamente.

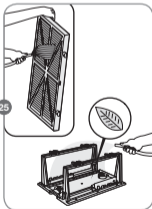
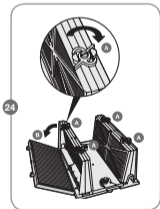
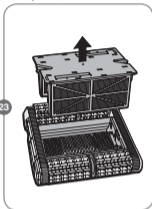
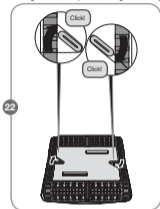
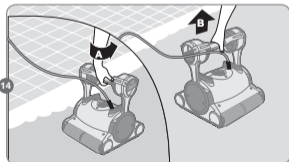
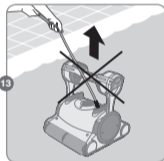
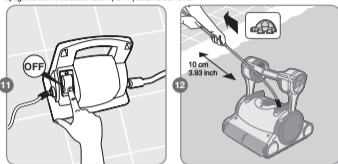

Coloque el cable en el lado derecho en frente del asa.
Derecho flotar hacia arriba. Flotador se enfrenta a la izquierda hacia abajo.

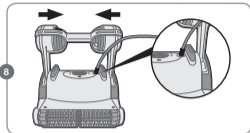

Sacuda el robot de lado a lado o póngalo boca abajo para soltar el aire retenido.

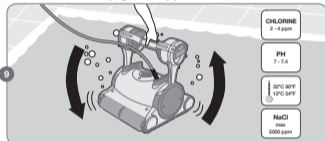

Remoje en agua y retuerza los PVA (cepillo Wonder) / anillos PVA (cepillo combinado)

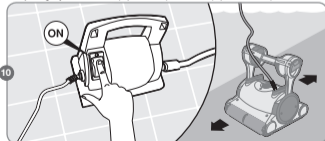

Cartridge
Optional

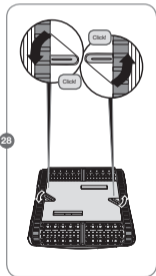
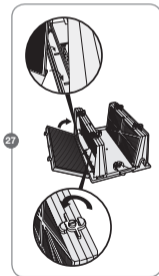
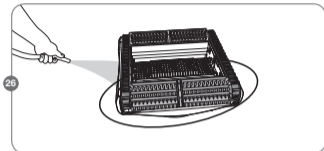

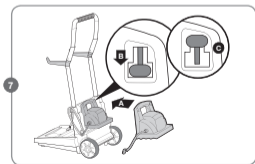
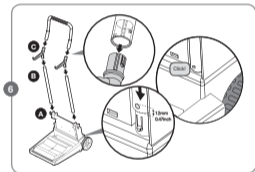
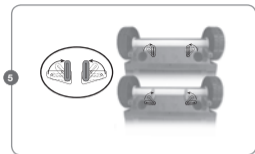
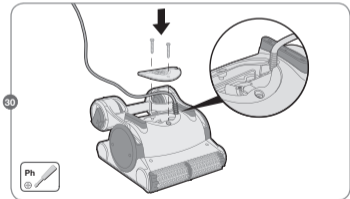
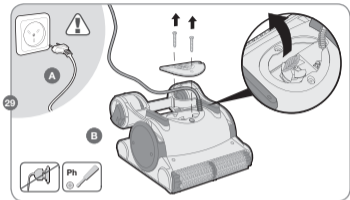



Montaje del Caddy

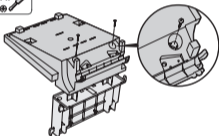

3



4



Straighten the cable from time to time.

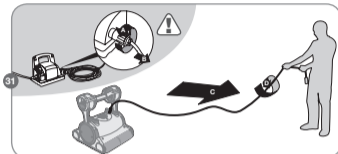

31

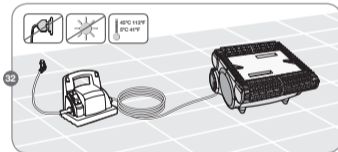

32

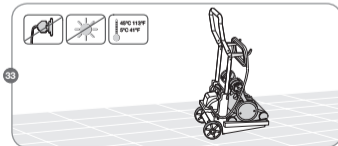

33

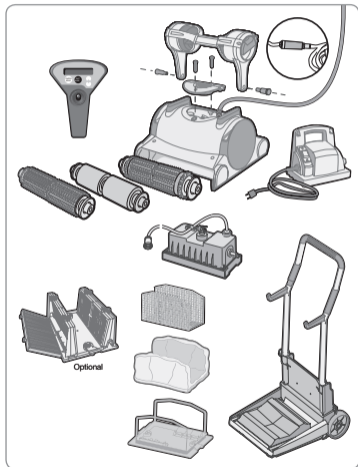

Instrucciones importantes de seguridad

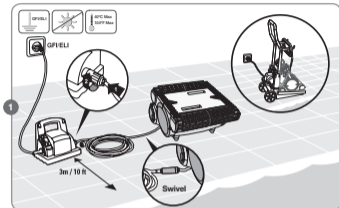

Standard Brush



Combined Brush



Wonder Brush

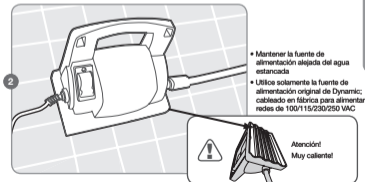

• Mantener la fuente de alimentación alejada del agua estancada

• Utilice solamente la fuente de alimentación original de Dynamic; cableado en fábrica para alimentar redes de 100/115/230/250 VAC



Atención!
Muy caliente!

Instrucciones operativas 30-44

Instructions d'opération 15-29



Instructions de sécurité importantes

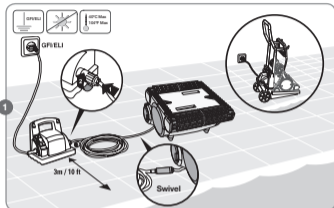

Standard Brush



Combined Brush



Wonder Brush

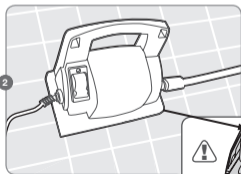

- Ne pas poser le boîtier électrique sur une surface humide
- Utiliser uniquement l'unité d'alimentation électrique du Dynamic - câblé en usine pour recevoir du courant en 100/115/230/250 VAC



Attention! Appareil très chaud!

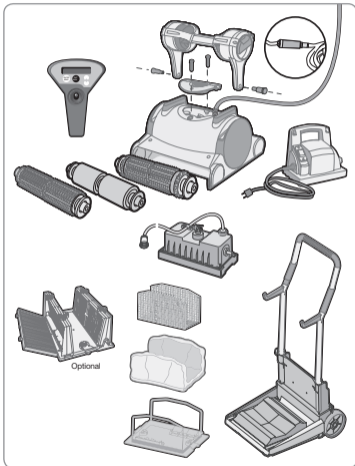



Redresser le câble de temps en temps



31

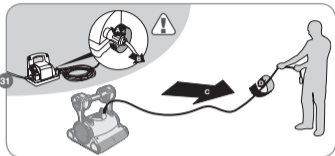

32

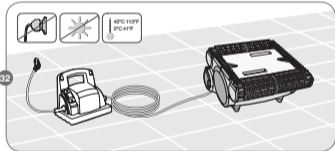

33

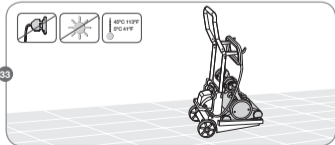

Montage du Caddy

3

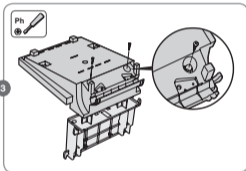

4

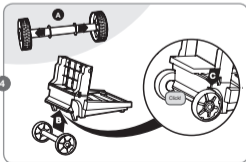

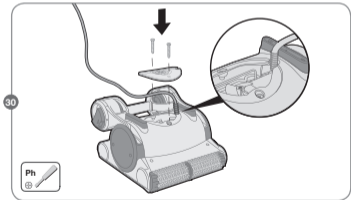
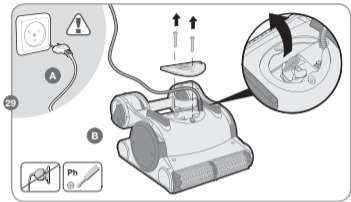
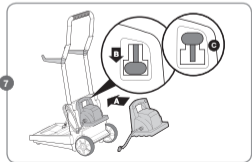
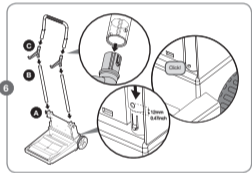
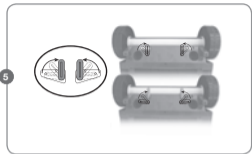

**Cartridge
Optional**

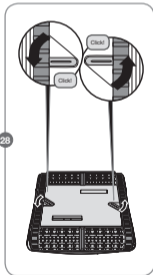
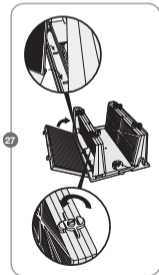
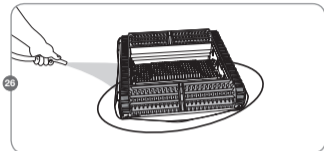

Placer le câble électrique sur le côté droit et sur la partie avant de la poignée
Flotteur droit face. Flotteur gauche doit faire face vers le bas.

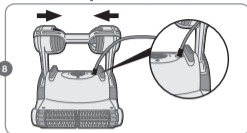

Secouez le robot sur les côtés ou de haut en bas pour libérer les bulles d'air

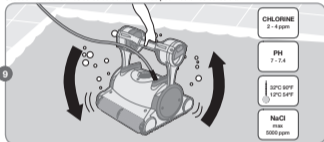

Standard Brush



Combined Brush



Wonder Brush

Tempérer les PVA et presser-les (brosses Wonder) / les anneaux PVA (brosses combinées) dans l'eau.

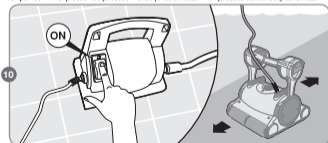

Bien que le robot s'éteigne automatiquement en fin de cycle de nettoyage, éteindre l'appareil manuellement

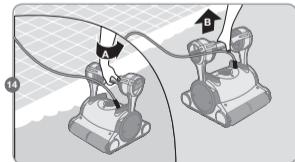
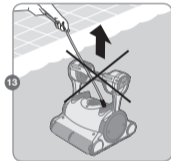
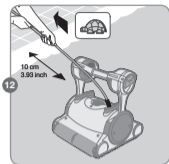
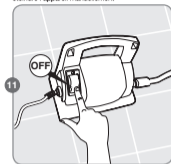

Il est recommandé de laver le cartouche après chaque cycle
Note: Pour les piscines très sales (comme par exemple lors d'un nettoyage de printemps) il est nécessaire d'ouvrir et de nettoyer le cartouche toutes les 1/2 heures de fonctionnement. Dans le cas contraire, le cartouche effectuera un recouvrement inefficace et sera incapable d'escalader les parois de la piscine

**Cartridge
Optional**

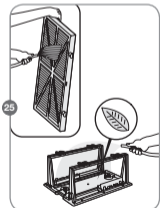
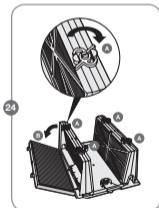
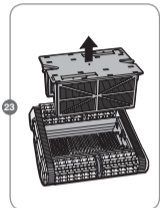
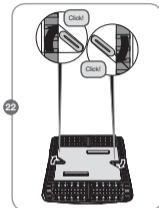

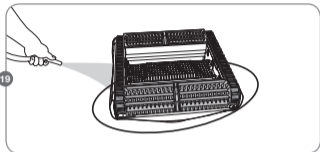

19

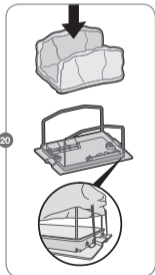

20

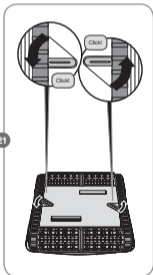

21

La télécommande



Ces boutons sont utilisés pour se déplacer entre les différents menus et les options.



Ce bouton s'utilise pour allumer la télécommande, pour sélectionner le menu désiré, pour envoyer ou pour régler un paramètre ou un programme.



Ce bouton s'utilise pour sortir du menu ou pour retourner à l'étape précédente.
Ce bouton est également utilisé pour éteindre la télécommande. Appuyer sur SORTIE [EXIT] plusieurs fois jusqu'à ce que la télécommande s'éteigne.



Si un paramètre a été modifié, juste avant la sortie définitive il peut vous être demandé d'envoyer votre nouveau réglage de paramètres.

Description et utilisation des menus

Programmes de nettoyage

- Régulier (Regular) – Programme de nettoyage du sol et des parois.
- Ultra Propre (Ultra Clean) – Mouvements plus lents pour un nettoyage intégral.
Note: Ultra Propre (Ultra Clean). Ce mode peut être sélectionné uniquement à partir du mode RÉGULIER.
- Bordure (Water Line) – Pour une attention particulière portée aux parois et aux bordures de l'eau.
Si vous choisissez les modes Bordure (Water Line) ou Ultra Propre (Ultra Clean) ces paramètres ne resteront pas dans la mémoire du robot nettoyeur de piscine pour le prochain cycle de nettoyage. Au lieu de cela, le robot nettoyeur de piscine retournera directement sur le mode RÉGULIER.
- Recouvrement de la piscine (Lap Pool) – Pour les piscines de formes spécifiques - étroites et longues.
Note: Si vous choisissez le mode de nettoyage Recouvrement de la piscine (Lap Pool), réglez la longueur de la piscine après avoir réglé ce mode.

Paramètres

- Durée du cycle (Cycle Time) – Pour sélectionner la durée du cycle de nettoyage la mieux adaptée.
- Longueur de la piscine (Pool Length) – Pour programmer la longueur de la piscine.
- Escalade des parois (Climbing) – Cette option permet de régler la fréquence d'escalade des parois, par exemple la fréquence à laquelle le robot nettoyeur de piscine devra escalader les parois.

Remplacement des piles de la télécommande

Si le message - Piles faibles - apparaît sur l'écran de la télécommande:

- Ouvrir le couvercle du compartiment à piles.
- Enlever les piles usagées de la télécommande.
- Placer deux piles de 1,5 V AAA dans le compartiment à piles de la télécommande comme montré sur le croquis à l'intérieur de celui-ci.
- Fermer le couvercle du compartiment à piles.

Si vous n'utilisez pas la télécommande pendant plus de 6 mois, retirer les piles.

RCU



Filter Bag



Il est recommandé de laver périodiquement le sac-filtre dans la machine à laver.
Utiliser le programme de nettoyage synthétique.

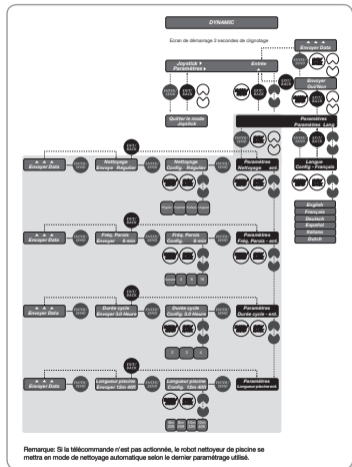

Remarque: Si la télécommande n'est pas actionnée, le robot nettoyeur de piscine se mettra en mode de nettoyage automatique selon le dernier paramétrage utilisé.

