

Swimming Pool and Spa Purification System

POOL PILOT PROFESSIONAL

by AquaCal AutoPilot, Inc.

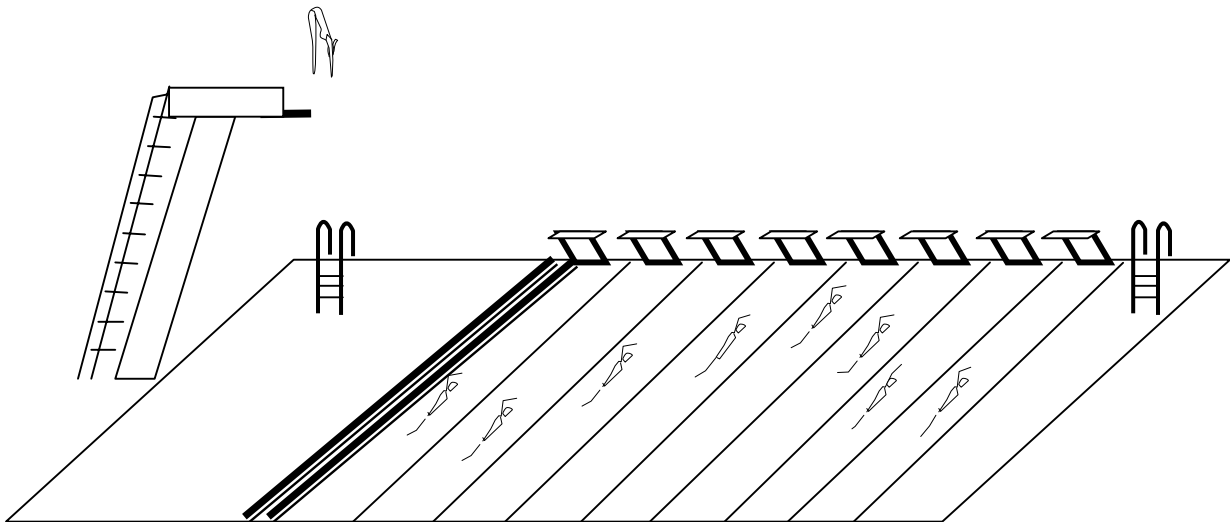

Installation / Operation Manual

IMPORTANT

Read This Manual Before Installing & Operating

#18516 Rev 3 9-23-09

Section 1a – GENERAL PRODUCT INFORMATION

POOL PILOT PROFESSIONAL

POOL AND SPA PURIFICATION SYSTEM

by AquaCal AutoPilot, Inc.

Record The Following Information

Installer: _____		
Date of installation: _____		Model Number: _____
Serial Number:#PSA _____	#PSB _____	#PSC _____
CC-15 / CC-30 Cell (Canada Only)		
Serial Number:#A 1 _____	#B 1 _____	#C 1 _____
Serial Number:#A 2 _____	#B 2 _____	#C 2 _____
Serial Number:#A 3 _____	#B 3 _____	#C 3 _____
Serial Number:#A 4 _____	#B 4 _____	#C 4 _____
Serial Number:#A 5 _____	#B 5 _____	#C 5 _____
Serial Number:#A 6 _____	#B 6 _____	#C 6 _____

Factory Direct Customer Assistance...

HOTLINE: 1.800.786.7751 or 1.727.823.5642

FAX: 1.727.824.0847

e-mail to: AutoPilotTechSupport@teamhorner.com

Visit Us On The Internet @

<http://www.autopilot.com>

Manufactured by

AquaCal AutoPilot, Inc.

2737 24th Street North • St Petersburg • Florida 33713, U.S.A.

Pool Pilot Professional

by AquaCal AutoPilot, Inc.

SPECIFICATIONS

AC Input Power

230 VAC 1.8 amps per board (Range: 1.8 – 10.8 amps)

The Professional is capable of 1 to 6 Power Control Boards and should match the number of cells in the Manifold

Chlorine Output (per cell)

SuperCell Type	Maximum Chlorine Output (unit set at High Power)
CC-15	2.5 lbs/day (1.14 kg/day) (Range: 2.5 – 15 lbs/day (1.14 – 6.84 kg/day))

ORP Input

Dry contact – 10 mA typical (ORP systems with 110 V output will require a relay kit, PN# 110-ORP)

Manifold

Ideal Flow Rate: 30 – 50 gpm (6.8 – 11.3 m³/hr)

Maximum Flow Rate: 100 gpm (22.6 m³/hr) maximum flow rate to the manifold assembly

Agency Approvals

- NSF/ANSI Standard 50 - Circulation System Components and Related Materials for Swimming pools, Spas/Hot Tubs.
- ETL tested to conform to the following UL specifications:
 - UL1081 - Standard for Safety for Swimming Pool Pumps, Filters and Chlorinators
- CAN/CSA-E335-1 - Safety of Household and Similar Electrical Appliances
- CE
 - EMC Standards EN61000-3-2

Section 1b – GENERAL PRODUCT INFORMATION



IMPORTANT SAFETY INSTRUCTIONS

READ AND FOLLOW ALL INSTRUCTIONS

INSTALLATION AND EQUIPMENT RELATED

Installation of all Professional models:

When installing and using your Professional Control Panel, basic safety precautions must always be followed, including the following:

1. Follow all aspects of the local and National Electrical Code(s) when installing your Control Panel.
2. During installation, mount your Control Panel to ensure the least amount of direct exposure to rain, garden sprinkler water, direct sunlight or any corrosive environment.
3.  **DANGER** – Risk of electrical shock. Install Control Box at least 10’ (3 m) for 115VAC Units, from the inside wall of the pool or spa using non-metallic plumbing. 5’ (1.5 m) minimum distance for 230VAC Units.
4. All field-installed metal components such as rails, ladders, drains or similar hardware within 10’ (3 m) of the spa or hot tub shall be bonded to the equipment grounding bus with copper conductors not smaller than No. 8 AWG in the U.S.A. and No.6 AWG in Canada.
5.  **WARNING** – Maintain water chemistry in accordance with manufacturer’s instructions.
6.  **DANGER** – To reduce the risk of injury, do not permit children to use this product unless they are closely supervised at all times. Children should not use spas, hot tubs or pools without permanent adult supervision.

Equipment Related

220Volt Models (fixed wiring)

1. A wire connector is provided on your Professional to connect a minimum No. 8 AWG (8.4 mm²) solid copper bonding conductor between this unit and any metal equipment, metal enclosures of electrical equipment, metal water pipe or conduit within 5’ (1.5 m) of the unit.
2. A bonding terminal is located inside your Professional. To reduce the risk of electrical shock, this terminal must be connected to the grounding means provided in the electrical supply panel with a continuous copper wire equivalent size to the circuit conductors supplying your Professional.

SAVE THESE INSTRUCTIONS

Section 1c – GENERAL PRODUCT INFORMATION

Table of Contents

POOL PILOT PROFESSIONAL

by **AQUACAL AUTOPILOT**
INC.

Section 1	GENERAL INFORMATION	
1a	Product Information and Contact Numbers	1
1b	Specifications	2
1c	Important Safety Instructions.....	3
1d	Table of Contents.....	4
Section 2	PARTS (Breakdown and part numbers)	
2a	Manifold Assembly.....	5
	Cell / Cell Cord	
	Tri-Sensor Assembly / Tri-Sensor Cord	
2b	Control Center.....	6
Section 3	INSTALLATION	
3a	Main Components.....	7
	Locating and Mounting the Control Center and Manifold	7
	Control Panel Connections	7
	Electrical Connections	
	Cell Cord and Sensor Assembly Connections	
3b	ORP Connections and Fuse Locations.....	8
Section 4	OPERATION	
4a	Control Panel	9
	Menu and Features	
4b	Pool Water Preparation	10
	Salt Requirement Chart	
	Start-Up Procedures.....	10
4c	Monitoring and Maintenance.....	11
	Water Chemistry Parameters	
	Visual Cell Inspection and Manual Cell Cleaning	
	Filter Backwashing	11
Section 5	TROUBLESHOOTING	
5	Troubleshooting.....	12

Section 2a – PARTS (Breakdown and part numbers)

Manifold Assembly

Manifold

The manifold assemblies come with 2, 3, 4, 5, or 6 cells, and the Tri-sensor mounted in series. Ensure that there is sufficient flow to the manifold base (30 – 50 gpm). Maximum flow rate to the manifold is 100 gpm. Union nuts are provided to allow easy disassembly.

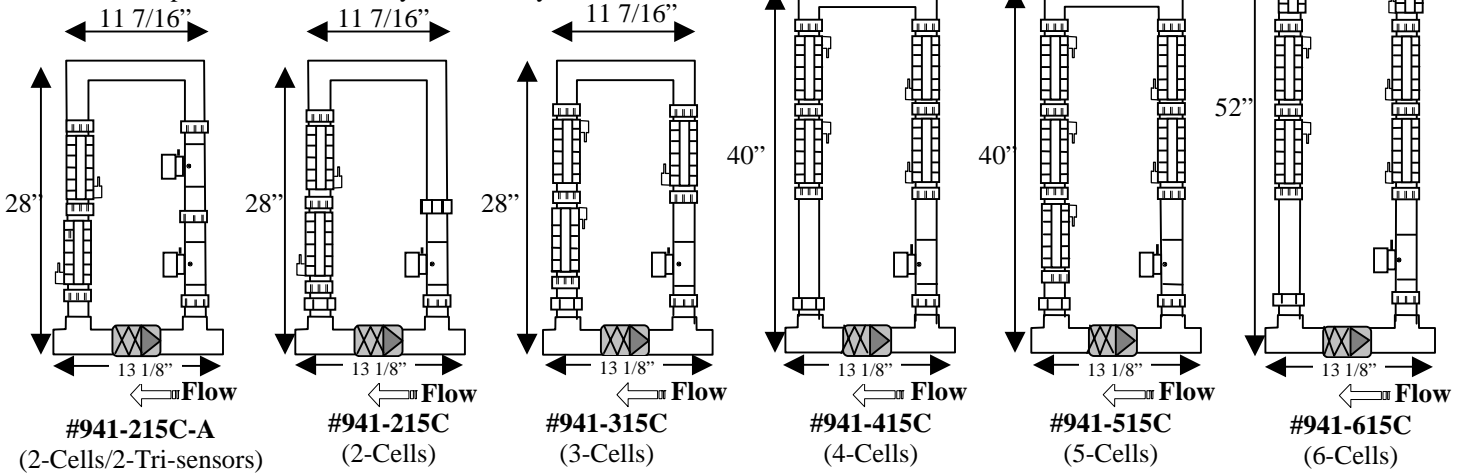

Cell: The Cell is installed with Unions on each end of the cell to allow quick and easy removal. Loosen the unions and remove the cell from the plumbing.

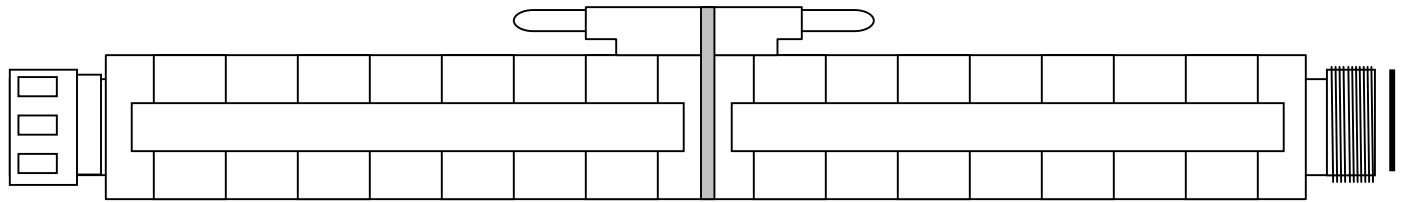
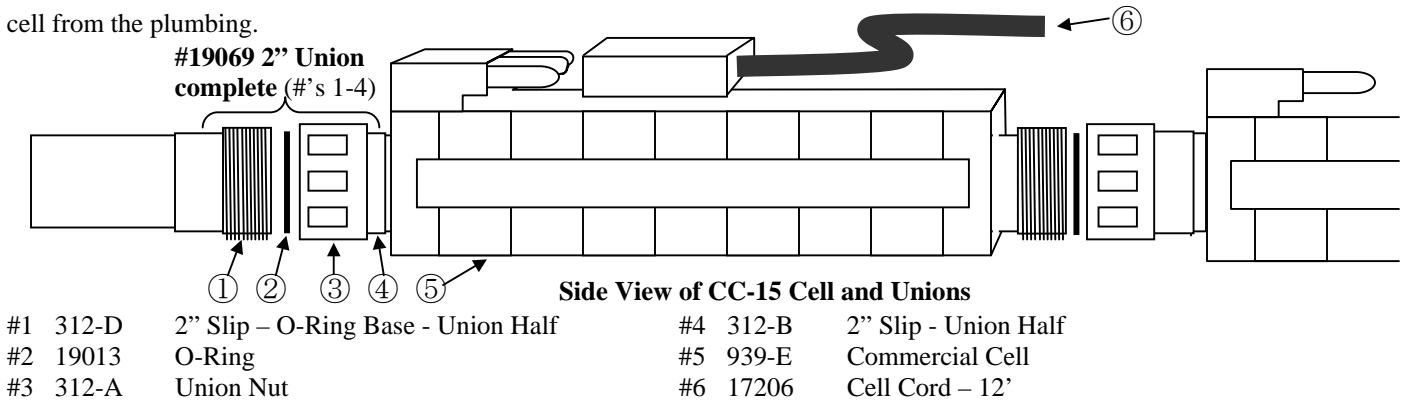

Tri-Sensor Assembly

#909-GO1.5

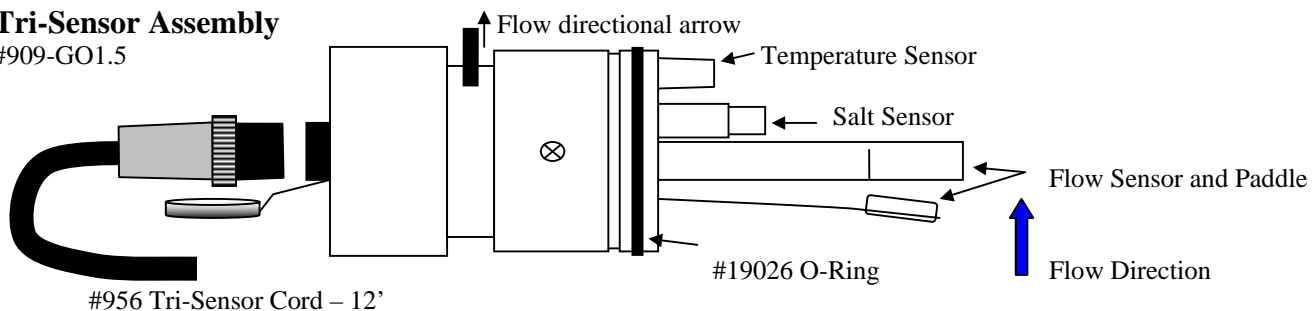

Section 3a –INSTALLATION

Main Components

CONTROL CENTER converts incoming AC power to Low Voltage DC power, which energizes the Cells.

ELECTROLYTIC CELL receives the Low Voltage DC power from the Control Center and initiates the electrolytic process. This process converts ordinary table salt (Sodium Chloride) to 100% Pure Sodium Hypochlorite which in turn purifies your pool. As the dissolved salt cycles through the cells, the electrolytic process splits the sodium from the chloride and generates purifier. After the chlorine reacts with the organics and debris in the water, the chlorine recombines with the sodium and the whole process is repeated over and over again.

TRI-SENSOR ASSEMBLY ensures that adequate flow, 30 - 50 gpm (6.8 – 11.3 m³/hr) ideal; salt, 2500 – 3500 ppm (2,5 – 3,5 g/l) ideal range; and water temperature are satisfactory to prevent abusive conditions for the cell to operate.

Locating and Mounting the Control Center and Manifold

⚠ CAUTION: Due to the weight of the Control Center, it is recommended to have another person assist you when marking and mounting to the wall.

The **Control Center** should be set on a vertical surface away from excessive exposure to heat and moisture. Ensure that you are attaching the Control Center brackets to a solid wall surface or wall stud. Failure to mount the control panel properly may result in the dislodging of the control panel, which can cause serious injury. Ensure a clear area behind the Control Center for proper convection cooling and a clear area in front of the control panel so that the front access door can swing open completely.

There are 12' (3.6 m) of **Cell and Tri-Sensor cords** provided with the unit. Ensure the **Manifold** is plumbed within that distance from the control panel with enough slack to allow for service or maintenance. Each cell is provided with 2" unions for easy access for service or inspection. Ensure that the unions are all installed with the male/female half unions on the same side of the cell body. This will allow a uniform design for replacement when needed. See manifold diagrams on page 5.

Control Panel Connections

Electrical Connections

Wiring. An electrical access panel is located on the right side of the control center for the input power, Tri-Sensor and optional ORP. Removal of the internal cover is not necessary for this installation. Your Professional Control Panel is capable of 220 – 240V @ 16 A, and 50/60 Hz input. Remove the side access panel and route the power wires through the strain relief. This Wiring Diagram is also attached to the side access panel.

⚠ WARNING: Ensure that the circuit breaker is set to OFF prior to installing. Connect your input wiring to the circuit panel with at least 16 amps of service. Ensure that this circuit is interfaced with the main circulation pump. This ensures that when the filter pump is turned off, the Professional is protected and also turned off.

Tri-Sensor Cord. The gray Tri-sensor cord is attached into the electrical access box. Remove the side access panel, route the Tri-sensor cord through the strain relief connector and connect to the terminals marked for the flow (Red, White), temperature (Black, Blue), and salt sensor (Green, Brown). The opposite end of the cord is connected to the Tri-sensor head plug. The Tri-sensor and head plug are keyed so that they must be aligned and matched up before securing. Do not force this connection as the pins can be damaged. Once inserted, secure the locking ring and tighten.

Cell Cord. Depending on the model, there will be (2) – (6) cell cords provided with the control center. Ensure that the cell cord is plugged firmly onto the cell terminals. The other end of the cell cord attaches to the terminal block at the base of the box. The black wire from the cell cord is matched to the center terminal (black wire) of the control center wiring. The other two wires from the cell cord (red and white wires) can be connected to either of the outer terminals (red wires) of the terminal block.

Labeling and Markings: To avoid mismatching or crossing cell terminals, ensure that each cell and cell cord is appropriately labeled with markings to identify them. AutoPilot Systems recommends using a marking system of A-1, A-2, A-3, etc... for each cell and cell cord, then marking the Power Supply with "PS-A" and Tri-sensor with "TS-A". If additional units are used, they should be labeled B-1, B-2, B-3, PS B, TS B, etc., C-1, C-2, C-3, PS C, TS C, etc. to ensure that no wires or cords become crossed.

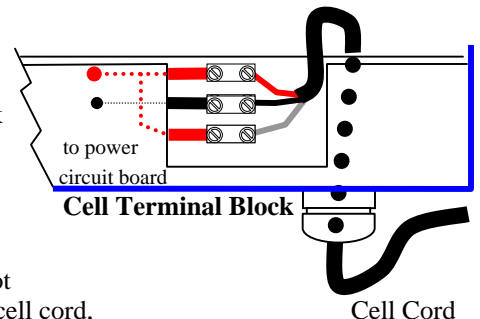
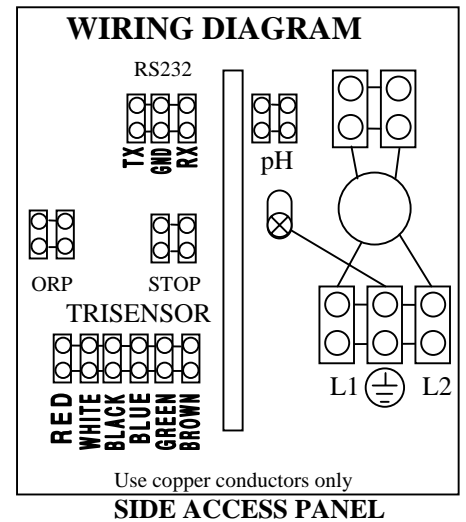

Section 3b – INSTALLATION

ORP Connections and Fuse Locations

ORP CONNECTIONS

When an **ORP chemical controller** is interfaced to your Professional, the controller will control the purifier Output. The ORP controller wires will attach to the terminal block, marked ORP, located on the left side electrical access box. Adjust your output level to 0%. As the controller measurement falls below the set point, the Professional is activated to produce chlorine until the set point is satisfied.

Check with your local commercial guidelines for minimum and maximum ORP levels.

⚠ NOTE: THE REMOTE CONNECTIONS ARE COMPATIBLE WITH EITHER DRY CONTACT CLOSURE OR SOLID STATE RELAY. DO NOT ENERGIZE THESE INPUTS! DAMAGE TO THE CONTROL PANEL WILL OCCUR AND THE WARRANTY WILL BE VOIDED.

Display will toggle between **ORP ON** and **OFF**.

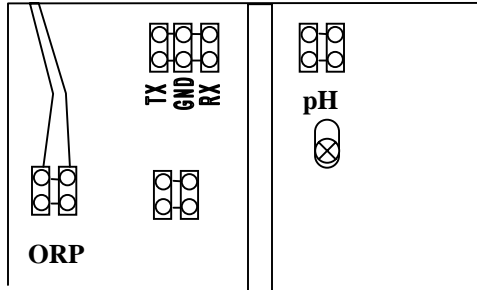
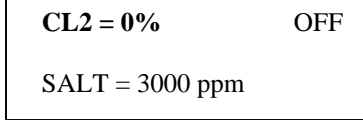

*ORP and pH controller supplemental instructional sheets are provided when the optional controller is ordered.

FUSE LOCATIONS

There are very few user serviceable parts internally. The only parts that may be serviced are the following fuses. Note that either US AGC or European 5 x 20 mm-sized fuses may be used. Follow the instructions on page 6 to access the fuses.

MAIN CONTROL BOARD CIRCUIT FUSE. The Control Board Circuit Fuse protects the microprocessor chip and is located on top left corner of the Main Controller Circuit Board, marked **F1**. This is a standard 2-amp 250V fast acting fuse.

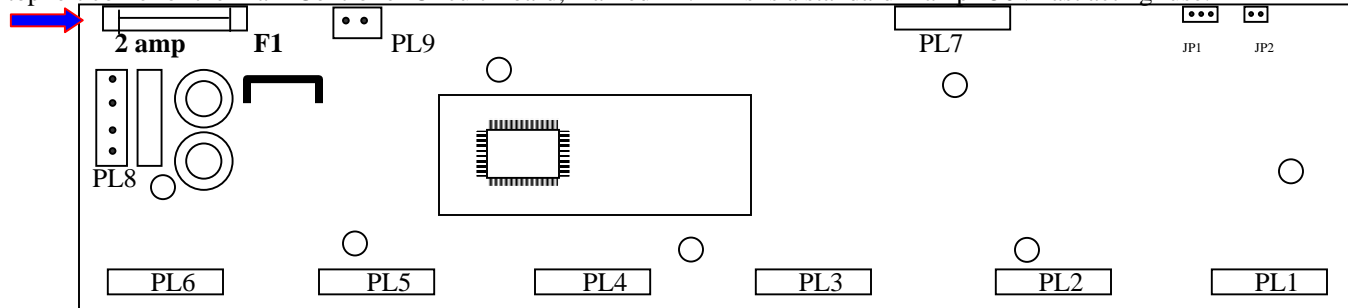

MAIN CONTROLLER CIRCUIT BOARD

POWER CIRCUIT BOARD FUSES

CELL FUSE. The Cell Fuse protects the Cell from over power conditions and is located at the upper left side of the circuit board, marked **F3**. This is a standard 20-Amp 250V fast acting fuse.

CONTROL FUSE. The Control Fuse protects the control circuit from over power conditions and is located at the upper right side of the circuit board, marked **F2**. This is a standard 3-Amp 250V fast acting fuse.

MAIN AC POWER FUSE. The Power Fuse and surge protector protects the circuit board from power surges and is located on the bottom left side of the circuit board, marked **F1**. This is a standard 6-Amp 250V fast acting fuse and MOV-1 (PN#14156). If this fuse is replaced and blows again, return the circuit board for repair or replacement.

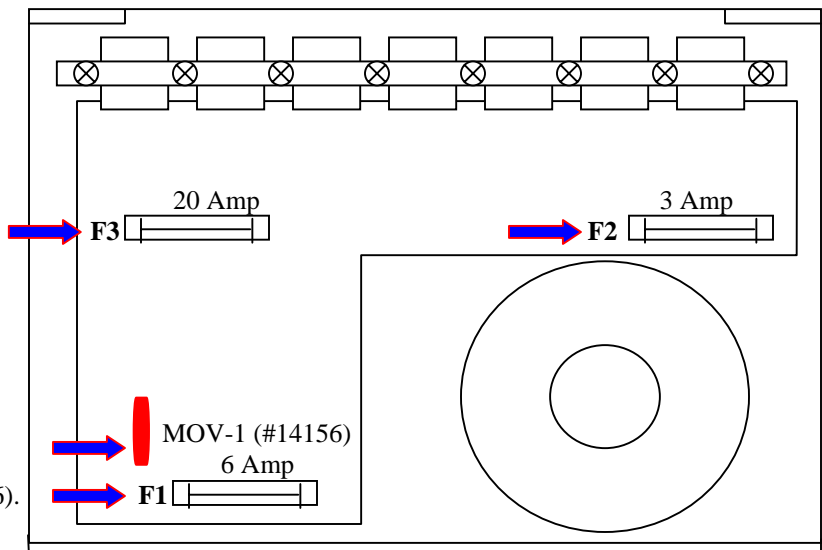

POWER CIRCUIT BOARD

Section 4a – OPERATION

Control Panel

Control Panel

The control provides a full information panel and display. There are several soft touch buttons that allow control of the system.

ON/OFF POWER CIRCUIT BREAKER – this main switch activates and deactivates the power going to the control center.

When extreme power surges occur, the circuit breaker will trip to the off position.

To reactivate, turn fully off, and then back on.

UP BUTTON: Press to increase the rate of sanitizer production. Also used in conjunction with the SERVICE button to step through the menu selections.

DOWN BUTTON: Press to decrease the rate of sanitizer production. Also used in conjunction with the SERVICE button to step through the menu selections.

SERVICE BUTTON: Press to enter the SERVICE MENU. Use the UP and DOWN buttons to scroll through the menu and the SERVICE button to select the function. The lists of functions in order are as follows:

ENABLE/DISABLE ALARM: Use UP/DOWN and SERVICE to select the desired state of the audible alarm.

SET REVERSING TIME: Use UP/DOWN and SERVICE to choose the reversing time. The reversing time can be set to reverse polarity every 1, 2, 3, 4, 6, 8, 12 or 16 hours of cell run time. The factory setting is 4 hours.

FORCE REVERSE: Press SERVICE to exit the service program and force all the cells to reverse in sequence.

CALIBRATE SALT: Press SERVICE to display the measured salt level. Use UP and DOWN to change the salt reading to match the actual value in the pool. Press SERVICE when done, which will immediately exit the Service mode.

REPLACE CELL: This is used to zero the accumulated ampere-hours when a cell is replaced. The display will show “Replace Cell 1”. Use UP/DOWN to select the cell to be replaced, and then SERVICE to reset the Ampere-hour counter.

SET POWER LEVEL: Use UP/DOWN and SELECT to set the power level to 8 amps or 6.5 amps, depending on the sanitizer requirements of the pool. The factory setting is 8 amps

ENGLISH/METRIC UNITS: Use UP/DOWN and SELECT to choose the system of units displayed.

FAHRENHEIT/CELSIUS DEGREES: Use UP/DOWN and SELECT to choose the unit of temperature displayed.

EXIT SERVICE MODE: Returns to normal operation.

*Note that after completing a function, the next function in sequence will be displayed for selection. This does not apply with those functions that exit service mode upon completion (FORCE REVERSE and CALIBRATE SALT)

TEST BUTTON: Press to initiate the test sequence. The Test display advances automatically in the following sequence:

Power Level

Reversing Time

Water Temperature

Condition of CELL 1, CELL 2, CELL 3, CELL 4, CELL 5 then CELL 6 (cell voltage, current and elapsed cell ampere-hour)

* Note: Wherever there is no CELL connected to the control center, the display will show “CELL X not found”.

After cycling through the sequence, the controller will resume normal operation.

AUDIBLE ALARM: The alarm will sound when there is no flow or low salt. Entering TEST or SERVICE will temporarily silence the alarm. The alarm can be disabled through the Service mode, but will be re-enabled if power is turned off and on again.

EXTERNAL SHUTOFF: A terminal block is provided in the connection box for an external shutoff and is labeled “STOP”. These contacts are normally closed, and sanitizer production will cease if they are opened. See page 7.

ORP CONTACTS: There is a terminal block in the connection box for an external ORP controller. Closed contacts override the controller setting and produce sanitizer as long as the ORP contacts remain closed. Purifier Output should be set to 0%.

* Note that the contacts are compatible with either a dry contact closure or a solid-state relay.

TRI-SENSOR ASSEMBLY: The Tri-sensor terminal block is in the connection box. The wiring diagram shows where to connect each colored wire. See page 7.

RS-232: This is for future expansion of “transmit and receive remote functions”.

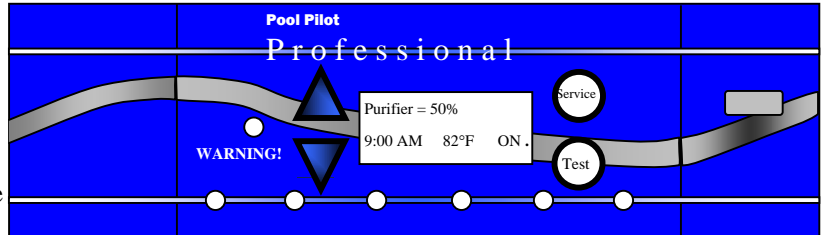

Section 4b – OPERATION

Pool Water Preparation

Salt Requirements

It is important that a salt residual of 2500 to 3500 ppm (2,5 – 3,5 g/l) be maintained at all times for peak efficiency. The amount of salt required depends on the size of the pool and the present salt level. We recommend the use of **AutoSoft Plus™** Water Conditioning Salt.

AutoSoft Plus™ salt contains 99.8% pure Sodium Chloride (NaCl) without Iodine or the Anti-Caking additive, Yellow Prussiate of Soda (YPS) that can cause a localized tint to the water or yellow staining on the cementitious finish if allowed to rest undissolved on the finish for extended periods of time. **AutoSoft Plus™** also contains the proper amount of stabilizer needed to maintain a proper level within the recommended range when added according to the salt chart on the box.

Granular Salt, Solar Salt or Water Conditioner Pellets, can also be used but will have different dissolve rates. In the event that the salt you use contains Iodine or YPS, constant brushing will help the dissolve rate and prevent staining due to the additives in the salt. Ensure that the salt you use contain a minimum purity of 99% Sodium Chloride (NaCl).

NOTE: Do not use Rock Salt due to its high levels of impurities.

First, determine the salt level with the provided salt test strips, and then use the chart below to determine the amount of salt to add. Before adding salt to the pool for the first time, turn your Professional's Circuit Breaker to "OFF" (0%), open the main drain valve, then with the main filter pump running, pour the salt around the perimeter of the pool. Circulate your water for a minimum of 24 hours to allow the salt to completely dissolve before turning your Professional's Circuit Breaker "ON".

Occasionally, salt may be lost due to bather splash out, filter backwashing, rain or makeup water dilution, or leaks. As you perform your periodic maintenance checks, if the salt residual falls below 2500 ppm (2,5 g/l), add the proper amount of salt to reestablish the optimum range.

POUNDS (kg) OF SALT NEEDED FOR 3000 PPM (3,0 g/l) RESIDUAL									
SALT Level Before Addition	Pool Volume in Gallons (m ³)								
	10,000 (37.7)	25,000 (94.3)	30,000 (113.2)	50,000 (188.7)	75,000 (283.0)	100,000 (377.4)	150,000 (566.0)	200,000 (754.7)	500,000 (1886.8)
0 ppm (0,0 g/l)	249 (113)	623 (283)	747 (340)	1245 (566)	1868 (849)	2490 (1132)	3735 (1698)	4980 (2264)	12450 (5659)
500 ppm (0,5 g/l)	208 (95)	519 (236)	623 (283)	1038 (472)	1556 (707)	2075 (943)	3113 (1415)	4150 (1886)	10375 (4716)
750 ppm (0,75 g/l)	187 (85)	467 (212)	560 (255)	934 (425)	1401 (637)	1868 (849)	2801 (1273)	3735 (1698)	9338 (4245)
1000 ppm (1,0 g/l)	166 (76)	415 (189)	498 (226)	830 (377)	1245 (566)	1660 (755)	2490 (1132)	3320 (1509)	8300 (3773)
1500 ppm (1,5 g/l)	125 (57)	311 (141)	373 (170)	623 (283)	934 (425)	1245 (566)	1868 (849)	2490 (1132)	6225 (2829)
2000 ppm (2,0 g/l)	83 (38)	208 (95)	249 (113)	415 (189)	623 (283)	830 (377)	1245 (566)	1660 (755)	4150 (1886)
2250 ppm (2,5 g/l)	62 (28)	156 (71)	187 (85)	311 (141)	467 (212)	623 (283)	934 (425)	1245 (566)	3113 (1415)

Note: The above chart is based on 1 lb. (2.2 kg) of salt added to 1,000 gallons (3.8 m³) to increase your salt residual 120-ppm (0,12 g/l).

Start Up Procedures

Keep the circuit breaker on your Professional in the OFF position until you get your water clear, blue, and properly balanced.

1. After balancing your water chemistry according to the Water Chemistry Parameters section on page 11 of this manual, add the proper amount of salt, as instructed in the Salt Requirement Chart above and circulate 24-hours prior to starting your Professional.
2. Your Professional runs in conjunction with the main filter pump so that whenever the pump and circuit breaker are on, the display will be on to indicate power is being sent to the Control Panel. The display will show the setting to which the unit is adjusted. The GREEN cell lights will be on whenever that cell is energized to produce purifier.
3. Use the up and down arrow buttons to set the Purifier % to 50% and allow the pool to operate normally. For the first two weeks, test the water chemistry parameters every 3-4 days. Adjust Purifier % as needed.

Section 4c – OPERATION

Monitoring and Maintenance

Water Chemistry - VERY IMPORTANT NOTE! Your Professional is designed to provide Purifier on a daily basis. We recommend the following water chemistry ranges and periodic checks to monitor your system and follow all local/state requirements.

Daily Checks:		Monthly Checks:			
Free Chlorine:	1.0 – 3.0 PPM	Calcium Hardness:	200 – 400 PPM	Salt Residual:	2500 – 3500 PPM
Or Bromine:	2.0 – 4.0 PPM	Total Alkalinity:	80 – 120 PPM	Langelier's Index:	± 0.3 pH of saturation
pH:	7.2 – 7.8	Cyanuric Acid:	60 – 80 PPM	Visual Cell Inspection	for wear, scale or debris

CHLORINE/BROMINE REQUIREMENTS: During Peak Purifier Demand (summer months, rainy season or heavy bather usage) it may be necessary to increase your Purifier output by increasing your output setting. Conversely, during Low Purifier Demand, you can decrease your output to a lower setting. For extremely Heavy Purifier Demand or to boost your chlorine residual levels quickly, you can supplement with a *Non-Chlorine Shock* containing POTASSIUM MONOPERSULFATE.

NOTE: During cold-water conditions, below 60°F, Purifier demand is reduced significantly. For colder climate regions with sustained low temperatures, contact your local pool professional for proper pool winterizing instructions.

pH: When your pH falls below the accepted range, your Purifier is used up very quickly. For pH levels higher than the accepted range, your Purifier becomes much less effective. Improper pH also contributes to the strong smell, red eyes, dry itchy skin and brittle hair conditions usually associated with “too much Chlorine”.

CALCIUM HARDNESS AND TOTAL ALKALINITY: Your Professional provides 100% pure sodium chloride and does not affect the calcium hardness or total alkalinity levels. When you start up and maintain your pool with proper water chemistry, it stays balanced much easier, until influenced by adding other ancillary chemicals or “out of balance” make-up water.

CYANURIC ACID (STABILIZER/CONDITIONER): This chemical goes by either trade name and allows your chlorine residual to last longer by protecting it from the UV rays of the sun. With low or no Cyanuric acid it is possible for the chlorine being produced, to be used up just as quickly as it is generated.

* Check your local commercial codes for maximum acceptable Cyanuric acid levels in commercial projects.

NOTE: For Bromine or indoor pools, it is not necessary to maintain a stabilizer level to protect the Purifier from the UV rays. However, it is recommended to maintain a minimal 15-ppm (0,015 g/l) to protect metallic fixtures from possible corrosion.

SALT RESIDUAL: Your Professional works most efficiently with salt levels between the above-recommended ranges. Low salt will cause premature deterioration on the Cell blades. For SALTWATER pools, your Professional is designed to handle up to 35,000 ppm (35,0 g/l) without harmful effects on the unit. However, high salt levels, above 6000 ppm (6,0 g/l) have been known to cause corrosion on metallic fixtures.

LANGELIER'S INDEX: (or Saturation Index) A mathematical formula used by Pool Professionals to ensure that your total water chemistry does not fall into a corrosive or aggressive condition. Either condition can cause premature damage to the Cell, any of your other equipment as well as your cementitious finish. Contact the factory for more details.

VISUAL CELL INSPECTION: Periodically inspect both ends of the cell. Follow the directions in the CELL section in the PARTS section, on page 5. The titanium Cell blades, seen inside the Cell body, should be straight and clear of any debris between the blades. Your Professional is designed to automatically self-clean calcium scale build up within the Cell. This is seen as a white flaky or crusty build-up on the edges or between the blades and will pre-maturely deplete the life of the cell. Certain conditions can cause a heavier scale build up that exceeds the self-cleaning capability and would need to be cleaned manually by the method described in the next section.

MANUAL CELL CLEANING:

With the Cell removed as described in the CELL section in the PARTS section, on page 5, use a high-pressure hose nozzle to spray off as much loose scale and debris as possible. Any remaining calcium scale can be treated with a mixture of one (1) part Muriatic Acid into four (4) parts water. Mix the solution in a pail, high enough to cover the Cell blades.

Remove the Cell cord and immerse the Cell so that the blades are completely covered in the solution for no more than 15 minutes intervals. Drain and flush with fresh water and re-inspect. Repeat the immersion if necessary.

 **CAUTION: ALWAYS ADD ACID TO WATER, never water to acid.**

NEVER USE ANY SHARP OBJECTS TO REMOVE SCALE. Scraping or scratching the titanium blade's edge or surface will allow chemical attack of the blade and cause premature failure of the Cell and will void your warranty.

FILTER BACKWASHING: We recommend turning off the circuit breaker on the Professional when backwashing the circulation filter.

Section 5a – TROUBLESHOOTING

TROUBLESHOOTING

<u>PROBLEM</u>	<u>CAUSE</u>	<u>SOLUTION</u>
1) Insufficient Purifier Production	A) The test kit reagents or test strips are old or expired. B) The unit is set too low in relation to purifier demand. C) The bather load has increased. D) Purifier loss due to intense sunlight E) The body of water being purified leaks. F) Low Salt.	A) Retest with new Reagents or Strips. B) Turn up the output setting. C) Same solution as (B) or add a Non-Chlorine Shock containing Potassium Monopersulfate. D) Check your stabilizer level and adjust if needed. If on Bromine, replenish bromine residual. E) Repair the leak and rebalance as needed. F) Check the salt residual level and adjust as needed.
2) Scale Build-up within the Cell	A) The water being purified contains high pH, total alkalinity and calcium hardness levels.	A) Calculate Langelier's Index to assure balanced water. Adjust chemicals if needed and clean the Cell as described on page 11.
3) DC Plug and Cell Terminals Burned	A) The Cell plug is not securely pushed onto the cell terminals, allowing moisture to seep into the plug. B) The Cell terminals leak.	A) Ensure the Cell cord plug is pressed completely onto the Cell terminal. Check the terminals and clean with a dry cloth to remove all dirt and corrosion. B) Contact the factory for Warranty Status/Procedures.
4) Premature Cell Failure (Requires Replacement)	A) Abnormally high Cell usage due to an insufficient Stabilizer (Cyanuric acid) level. B) Debris in the Cell.	A) Check the stabilizer level as recommended and adjust. B) Inspect the Cell monthly and clean debris if needed.
5) White Flakes in the Water	A) This occurs when excessive calcium hardness is present. This should cease after a few days.	A) Visually inspect Cell for scale build-up and clean the cell as described on page 11. Adjust your water chemistry as needed.
6) No Green Lights with Power to the Control Panel	A) On/Off Circuit Breaker tripped. B) Control Panel Circuit Board Fuse Blown	A) Reset the On/Off Circuit Breaker Switch. B) Replace Fuse. See page 8 for fuse rating and location.
7) "NO FLOW" Message	A) Insufficient Flow (Ideal 30 - 50 gpm) (6.8 – 11.3 m ³ /hr) B) A Flow switch wire is loose.	A) Ensure your Filter and Cell are clean of debris. Ensure there are no valves diverting flow away from the cell. B) Check each end for tightness onto the terminals.
8) "LOW SALT" message (Purifier is still generating)	A) Low salt.	A) Check residual salt level and adjust if needed.
9) "LOW AMPS" message	A) Very cold pool water. B) The Cell is scaled. C) Possible Cell failure.	A) Lower the output and add a Non-Chlorine Shock containing Potassium Monopersulfate to the pool until the water temperature rises above 50°F. B) See #2 of this section. C) Check with a 957 tester and replace if needed. Also see #4 of this section.
10) No GREEN CELL light (Cell Life Depleted)	A) Low Cell Amperage. B) The Cell Cord is Disconnected from the Cell C) Fuse Blown on Power Module	A) Replace cell. B) Ensure that the cord is firmly pressed into the cell. C) Replace Fuse. See page 8 for fuse rating and location.

Pool Pilot Professional

Manufactured by
AquaCal AutoPilot, Inc.
2737 24th Street North • St Petersburg • Florida 33713, U.S.A.