

AutoPilot[®] Owner's / Installation Manual

Pool Pilot[®] Professional

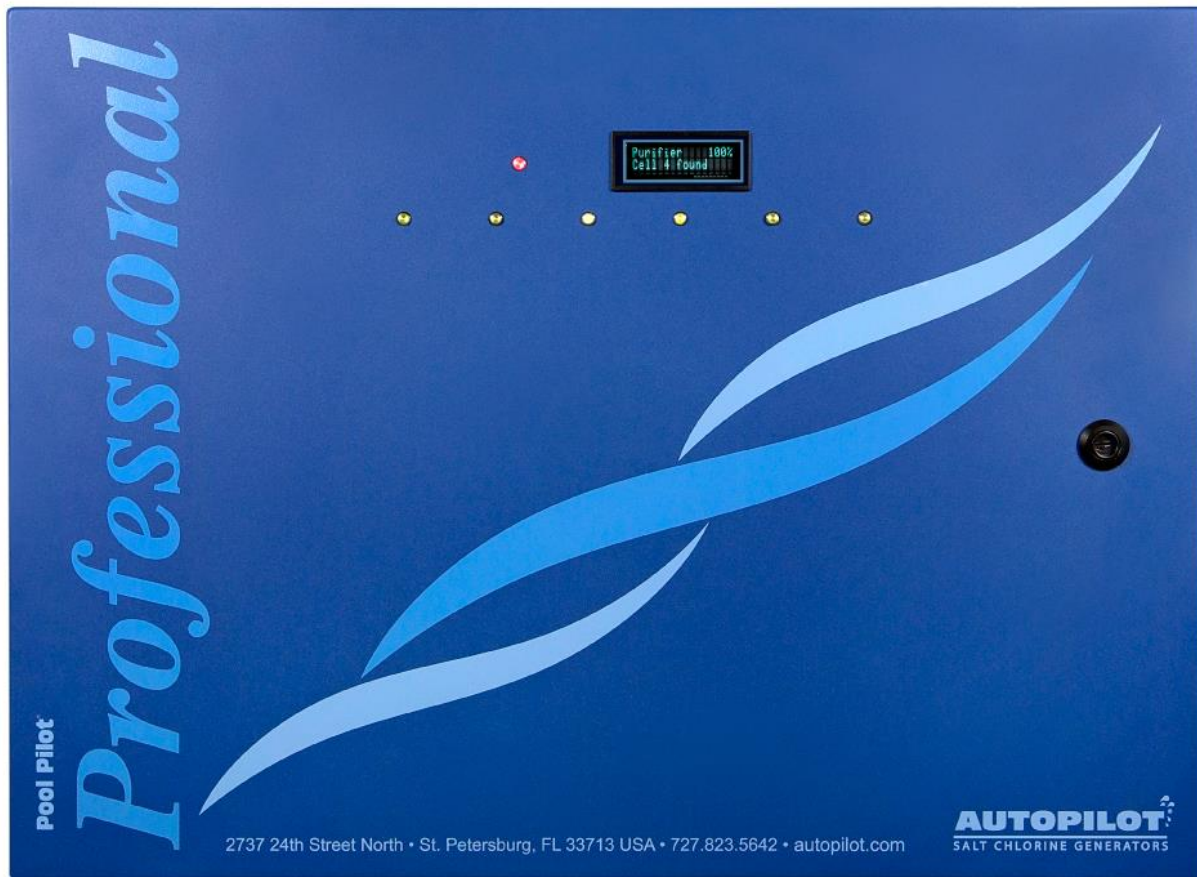

Important!

This manual covers the installation and operation of the Pool Pilot[®] Professional Salt Chlorine Generators.
Read this manual and product labels before installing or operating this equipment.

INSTALLER: THIS DOCUMENT IS PURCHASER'S PROPERTY AND IS TO REMAIN WITH THE EQUIPMENT OWNER

Table of Contents

Section 1 - Safety Information	
1.1 Important Safety Instructions	iv
Section 2 - General Information	
2.1 Contacting AquaCal AutoPilot, Inc.	1
2.2 Pool Pilot® Professional Model Options	1
2.3 Main Components	2
2.3.a Control Center	2
2.4 Cells and Manifold Assembly	3
Section 3 - Owner Quick Start & Run	
3.1 How Your Chlorinator Works	4
3.2 Water Balance and Chemistry Recommendations	4
3.3 Owner / Operator Control Buttons, Check System Fault and Audible Alarm	5
3.3.a UP and DOWN Arrows	5
3.3.b MENU/ENTER Button	5
3.3.c On / Off Power Circuit Breaker	5
3.3.d TEST Button (Diagnostic Menu)	6
3.3.e WARNING Light and Audible Alarm	6
3.4 Normal Display Modes	6
Section 4 - Specifications and Approvals	
4.1 Specifications	7
4.2 Manifold Pressure Drop vs Flow	7
Section 5 - Features	
5.1 Patented Temperature Compensation	8
5.2 Water Manifold Assemblies - Available Options	8
5.2.a Automatic - Flow Bypass Manifold Assembly	8
5.2.b Cell	9
Section 6 - Maintenance	
6.1 Accessing the Power Module	10
6.2 Removing / Inspecting / Cleaning Tri-sensor	11
6.2.a Tri-sensor Assembly Overview	11
6.2.b Inspect Tri-sensor	11
6.2.c Cleaning Tri-sensor / Salt Sensor	12
6.2.d Test Tri-sensor Flow Switch	12
6.3 Servicing the Cell	13
6.3.a Removal	13
6.3.b Visual Inspection	13
6.3.c Manual Cleaning	14
6.3.d Installing	14
6.4 Winterizing	14
6.5 Spring Start Up	15
Section 7 - Programming	
7.1 Control Panel	15
7.1.a Button Overview	15
7.1.b On / Off Power Circuit Breaker	15

7.1.c Up or Down (Δ / ∇) Buttons	15
7.1.d MENU/ENTER Button	16
7.1.e TEST Button (Diagnostic Menu)	16
7.1.f WARNING Light and Audible Alarm	16
7.1.g Cell Indicator Lights	17
7.1.h Display Overview	17
7.2 Basic Operational Programming	17
7.2.a Adjusting the Purifier Output %	17
7.2.b Boost	17
7.2.c Purifier Mode	18
7.2.d Purifier % Adjustment Procedure	18
7.3 Review of Main Menu Programming	19
7.3.a Enable / Disable Audible Alarm	19
7.3.b Boost	19
7.3.c Set Reverse Time	20
7.3.d Force Reverse	20
7.3.e Replace a Cell	20
7.3.f Set Cell Power	20
7.3.g English/Metric (units)	20
7.3.h Set Temperature Unit	20
7.4 Review of Installer Menu Programming	21
7.4.a Calibrate Temperature	21
7.4.b Calibrate Salt	21
7.4.c Set Pool Volume	21
Section 8 - Installation	
8.1 Basic System Overview	22
8.2 Planning the Installation	23
8.3 Installation Steps	23
8.4 Mounting the Control Center	23
8.5 Plumbing the System	24
8.5.a Plumbing the Manifold Assembly	24
8.5.b Plumbing for Convection Cell Applications	24
8.5.c Flow Rates 20 – 70 gpm (76 – 265 L/min)	25
8.6 Preparing the Pool Water	25
8.6.a Calculating Pool Volume	25
8.6.b Steps to Prepare Water	26
8.6.c Adding Salt	26
8.7 Programming at Installation	27
8.8 Electrical Connections	28
8.8.a AC Input Voltage	28
8.8.b Bonding	28
8.9 High Voltage Wiring	28
8.10 Low Voltage Wiring	29
8.10.a Tri-sensor Cord	29
8.10.b Cell Cord	29
8.11 ORP Connection	30

Section 9 - Troubleshooting	
9.1 Troubleshooting	31
Section 10 - Reference	
10.1 Basic Water Chemistry	37
10.1.a Chlorine	38
10.1.b pH	38
10.1.c Total Alkalinity	38
10.1.d Calcium Hardness	38
10.1.e Cyanuric Acid	39
10.2 Using the Saturation Index	39
10.3 Salt Addition Chart	40
Section 11 - Approvals	
11.1 Agency Approvals	41
11.2 FCC Compliance	41

SECTION 1 - SAFETY INFORMATION

1.1 Important Safety Instructions

When installing and using this electrical equipment, basic safety precautions should always be followed, including the following:

READ AND FOLLOW ALL INSTRUCTIONS.

- A green colored terminal or terminal marked G, GR, Ground, Grounding, or the  symbol is located inside the power center terminal box or compartment. To reduce the risk of electric shock, this terminal must be connected to the grounding means provided in the electric service panel with a continuous copper wire equivalent in size to the circuit conductors supplying this equipment.
- Follow all state, local, and National Electrical Code(s) (provincial and Canadian Electrical Code(s) if applicable) unless local guidelines supersede.
- For personal safety, and to avoid damage to equipment, follow all safety instructions displayed on the equipment and within this manual. Repair and service of your AutoPilot® chlorinator must be performed by qualified service personnel.
- Should you suspect your chlorine generator is not performing properly, refer to the Troubleshooting section in this manual to determine if service is required. See "Troubleshooting" on page 31.
- Warranties will be voided if the chlorinator has been improperly installed. Failure to properly operate, maintain or repair the AutoPilot® chlorinator will void the factory warranty.

SAFETY SIGNALS

Throughout this manual safety signals are placed where particular attention is required.



WARNING - Failure to heed the following may result in permanent injury or death.



CAUTION - Failure to heed the following may result in equipment damage.



WARNING - Failure to heed the following may result in permanent injury or death.

- **RISK OF ELECTRICAL SHOCK** - Disconnect all AC power when installing or servicing this system. Follow all state, local, and National Electrical Code(s) (provincial and Canadian Electrical Code(s) if applicable) unless local guidelines supersede. Use copper conductors only.
- **RISK OF ELECTRICAL SHOCK** - To reduce the risk of electrical shock, replace damaged cord immediately.
- **RISK OF ELECTRICAL SHOCK** - The AutoPilot® chlorinator contains no owner-repairable components. Repairs must not be attempted by untrained and / or unqualified individuals. If service is deemed necessary, contact installing dealer or AquaCal AutoPilot Customer Support.
- **RISK OF ELECTRICAL SHOCK** - A bonding lug has been provided on the outside of the power supply. This lug permits the connection of a No. 8 AWG (8.4 mm²) solid copper-bonding conductor (No. 6 AWG in Canada). Make this connection between the Pool Pilot® power supply and all other electrical equipment and exposed metal within 5 ft (1.5 m) of the unit. All field-installed metal components (such as rails, ladders, drains, etc.) within 10 ft of the pool, spa, or hot tub, must be bonded to the equipment grounding bus using copper conductors not smaller than No. 8 AWG (8.4 mm²) (No. 6 AWG in Canada). Install control center at least 10' (3 m) from the inside wall of the pool or spa using non-metallic plumbing.
- **RISK OF ELECTRICAL SHOCK** - A disconnect device incorporated into the fixed wiring must be included in the supply circuit (such as a time clock, relay, or circuit breaker).
- **RISK OF ELECTRICAL SHOCK** - Connect only to a branch circuit protected by a ground-fault circuit-interrupter (GFCI). Contact a qualified electrician if you cannot verify that the circuit is protected by a GFCI.

- RISK OF ELECTRICAL SHOCK - The Pool Pilot® unit must be connected only to a supply circuit that is protected by a ground-fault circuit-interrupter (GFCI). The GFCI must be tested on a routine basis. To test, push the GFCI test button. Power should be interrupted. Push the reset button. Power should be restored. If the GFCI fails to operate in this manner, it is defective.
- RISK OF ELECTRICAL SHOCK - If the ground-fault circuit-interrupter (GFCI) interrupts power to the equipment without the test button being pushed, a ground current is flowing with a possibility of an electrical shock. Do not use equipment. Disconnect the equipment and have the problem corrected by a qualified service representative before using.
- CHEMICAL HAZARD - To avoid damaging splashes, always add acid to water, never water to acid. Wear safety glasses and use other appropriate personal protection equipment.
- CHEMICAL HAZARD - Always follow the instructions on the manufacturer's label whenever handling or using chemicals.
- CHEMICAL HAZARD – Heavy pool (or spa) usage and higher temperatures may require a higher chlorine output in order to maintain proper free available chlorine residuals.
- WATER CHEMISTRY SAFETY - Improper water chemistry can present a serious health hazard. The proper residual chlorine level and water chemistry must be maintained. The addition of certain pool maintenance chemicals can reduce the effectiveness of chlorine. Maintain pool / spa water per standards detailed later in this manual.
- COMBUSTIBLE HAZARD – The AutoPilot® chlorinator is equipped with an electronic flow switch that automatically turns the unit off in the event of a “low water flow” situation. Do not tamper in any way with this safety feature.
- CHEMICAL HAZARD – CHLORINE GAS BUILDUP CAN OCCUR WITH IMPROPER WIRING: To reduce the risk of personal injury the Pool Pilot® power center must be installed on and wired to the load side of the time clock, electronically controlled switch, or relay load side, so that it will receive power only when the pool pump is on. Dangerous chlorine gas buildup can occur. The Pool Pilot® should never be energized when the pool pump is OFF and there is no water flow.
- PERSONAL SAFETY HAZARD – To reduce the risk of injury, do not permit children to operate this device.
- RISK OF CHILD DROWNING OR INJURY - Children must be closely supervised at all times around pool or spa equipment.

 CAUTION - Failure to heed the following may result in equipment damage.

- The Pool Pilot® must be installed and operated as specified. Failure to do so will void the equipment warranty.
- To permit proper air circulation, the Pool Pilot® power supply must be mounted at least 1ft (30 cm) above ground level or any other air flow obstruction.
- Special measures are required in the event of freezing conditions. Your chlorinator may be damaged if measures are not taken in advance of freezing conditions. Equipment damage due to freezing conditions is NOT covered under the equipment warranty.
- Do not use a pool cleaner or vacuum head with wheels, as wheels can leave track marks on newly-plastered pools. Do not allow Granular salt to pile up in one location without brushing, as staining may occur.
- For all newly constructed or resurfaced plaster pools: Do not operate the Pool Pilot® with newly poured or resurfaced pool plaster. Before adding salt and operating the chlorinator, wait 30 days after construction is completed to allow proper curing of the surface material. Follow the pool surface manufacturer's guidelines for your specific pool. FOR NEW VINYL LINER POOLS, contact the manufacturer for recommended instructions before adding salt and operating the Pool Pilot®.
- Salt is an inherently corrosive material. While the recommended level of salt for your AutoPilot® product should not damage your equipment, excessively high chlorine levels can cause corrosion damage to pool fixtures and equipment. Consult your pool professional for equipment selection, proper use and maintenance of these products.
- For maximum cell life, maintain water in a balanced condition according to the Saturation Index. Water maintained in a scaling condition will shorten cell life and may render the Pool Pilot® inoperative. Damage, and / or service calls, caused by improper water balance will NOT be covered under the equipment warranty.

- Scraping or scratching the titanium blade's edge or surface will damage the blade catalyst coating and cause premature failure of the cell. Never use any sharp or metallic objects to remove scale. The warranty will be voided.
- Reduced polarity reversing cycle times will reduce cell life and should only be used due to uncontrollable scale formation on the cell. ALWAYS test and adjust water balance before attempting scale control via shortening reverse period.

SAVE THESE INSTRUCTIONS

SECTION 2 - GENERAL INFORMATION

2.1 Contacting AquaCal AutoPilot, Inc.

If you need to call AquaCal AutoPilot, Inc. for questions, service, or parts, please have your model and serial numbers available. Also have the name of your installer and date of your equipment's installation. Please refer to our website for the latest manual revisions, additional information and helpful service advice.

Website	www.autopilot.com
Phone	(727) 823-5642
Fax	(727) 821-7471
Address	AquaCal AutoPilot, Inc. 2737 24th Street North St. Petersburg, FL 33713, USA

Installation Co.:	Installation Date:	Model #:
Power Supply (A) Serial #	Power Supply (B) Serial #	Power Supply (C) Serial #
Cell Serial #: A1	Cell Serial #: B1	Cell Serial #: C1
Cell Serial #: A2	Cell Serial #: B2	Cell Serial #: C2
Cell Serial #: A3	Cell Serial #: B3	Cell Serial #: C3
Cell Serial #: A4	Cell Serial #: B4	Cell Serial #: C4
Cell Serial #: A5	Cell Serial #: B5	Cell Serial #: C5
Cell Serial #: A6	Cell Serial #: B6	Cell Serial #: C6

2.2 Pool Pilot® Professional Model Options

To reduce the risk of personal injury, the Pool Pilot® Professional control center must be installed on an automation filter pump relay wired to the load side of the time clock, electronically controlled switch, or relay load side so that it will receive power only when the pool pump is on. Otherwise, dangerous chlorine gas buildup can occur. The chlorinator should never be energized when the pool pump is off and water is not flowing through the unit.

Chlorinator sizing must comply with all state and local codes. Please contact your local health department for specific requirements or contact your local AquaCal AutoPilot, Inc. representative for assistance. For more information on sizing, see our Commercial Sizing Calculator at www.autopilot.com.

The chlorine output for each of the Pool Pilot® Professional chlorinator models, which is based on a 24 hour chlorinator / pump run time and a salt concentration of 3,500 ppm (mg/L), is listed here.

Model (w / Mfid Assy & PPC5 Cell)	Chlorine Output lbs. (kg) Per 24 Hours
Pool Pilot® Professional PPP-2	5.24 lbs. (2.05 kg)
Pool Pilot® Professional PPP-3	7.86 lbs. (3.08 kg)
Pool Pilot® Professional PPP-4	10.48 lbs. (4.11 kg)
Pool Pilot® Professional PPP-5	13.10 lbs. (5.14 kg)
Pool Pilot® Professional PPP-6	15.72 lbs. (6.16 kg)

Model (w / PPC5 Convection Cell)	Chlorine Output lbs. (kg) Per 24 Hours
Pool Pilot® Professional PPP-2-CONV	4.53 lbs. (2.05 kg)
Pool Pilot® Professional PPP-3-CONV	6.79 lbs. (3.08 kg)
Pool Pilot® Professional PPP-4-CONV	9.06 lbs. (4.11 kg)
Pool Pilot® Professional PPP-5-CONV	11.32 lbs. (5.14 kg)
Pool Pilot® Professional PPP-6-CONV	13.59 lbs. (6.16 kg)

2.3 Main Components

2.3.a Control Center

The Pool Pilot® Professional Control Center converts incoming AC power to low voltage DC power, which energizes the cells. The power modules that energize the cells are mounted vertically inside the control center.

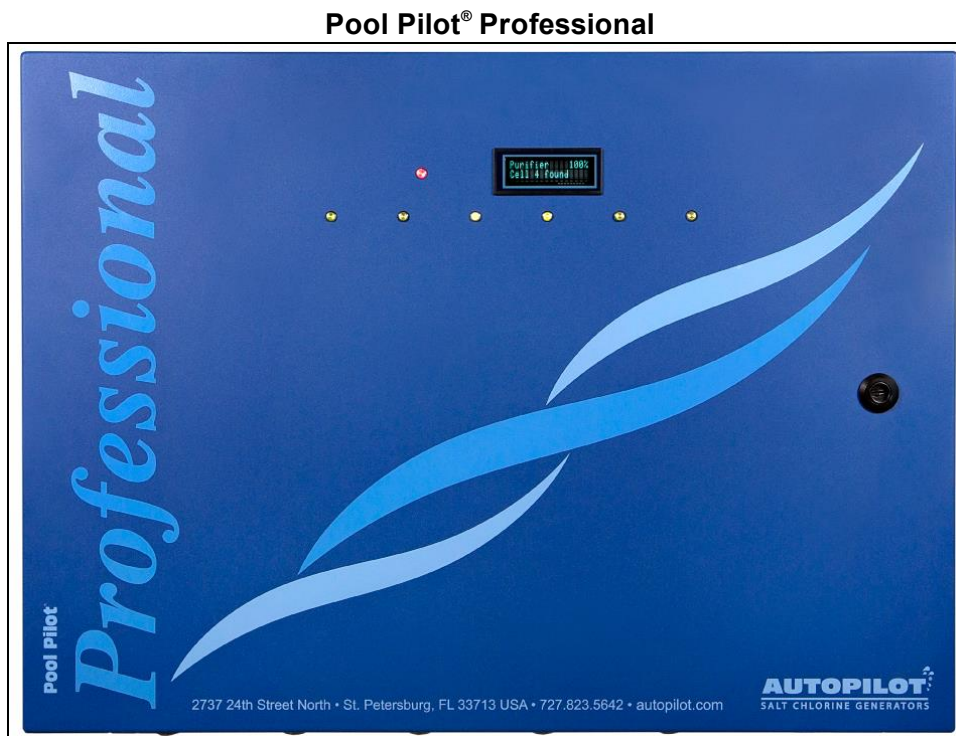

Figure 1

2.4 Cells and Manifold Assembly

The cell assembly consists of a clear PVC housing containing titanium metal coated cell blades. The electrolytic cell receives the low voltage DC power from the control center and initiates the electrolytic process. This process converts ordinary table salt (Sodium Chloride) to 100% pure Sodium Hypochlorite which in turn purifies your pool. Water from the pool circulation system is directed through the cell. As the dissolved salt cycles through the cells, the electrolytic process splits the sodium from the chloride and generates chlorine. After the chlorine reacts with the organics and debris in the water, the chlorine recombines with the sodium and the process is repeated.

The manifold assembly model #941-215AC is shown below and consists of two commercial PPC5 cells. The Pool Pilot® Professional can accommodate up to a six (6) cell manifold assembly. Please note that one power module per cell is required. See "Water Manifold Assemblies - Available Options" on page 8.

The cell is installed with unions on each end to allow quick and easy removal.



Figure 2

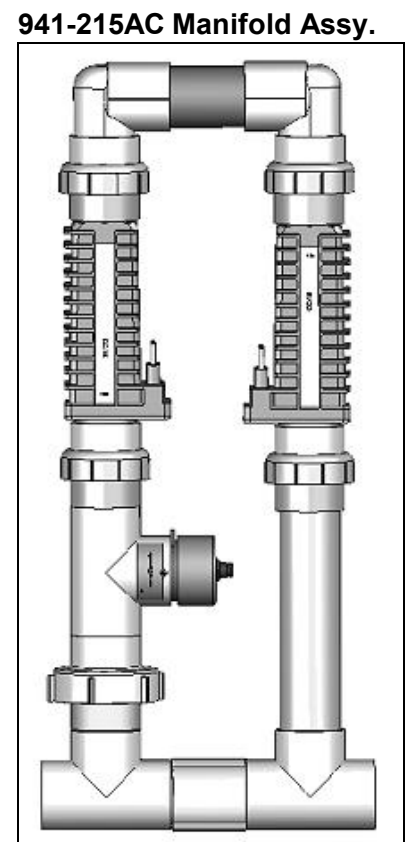

Figure 3

SECTION 3 - OWNER QUICK START & RUN

3.1 How Your Chlorinator Works

The Pool Pilot® Professional is designed to handle the purification needs of commercial swimming pools and spas. The amount of chlorine required for proper sanitization will vary based on the pool size and factors such as water temperature, bather load, exposure to direct sunlight, and special water features.

The system requires a low concentration of dissolved salt (sodium chloride) in the water that is normally maintained between 3,000 and 4,500 ppm (mg/L). The AutoPilot® unit uses the salt to generate chlorine, which your pool / spa requires to remain sanitized. The chlorine reverts back to salt after treating the water. Since the chlorine generation process does not reduce pool water salinity, there is minimal loss during a swimming season. Salt can be lost due to filter back washing, rain water overflow, leaks, or bather splashing / carry out, but not through evaporation.

The water circulation pump must be operating for your Pool Pilot® to produce chlorine, so run time is one of several key factors to maintaining proper sanitizer levels. Refer to your local health codes and / or your pool service professional for required pool filtration turnover rates and suggested pump run times.

3.2 Water Balance and Chemistry Recommendations

Water balance is the relationship between different chemical measurements in your pool water. A pool that is balanced has proper levels of pH, Total Alkalinity and Calcium Hardness. Balanced water can also be defined as water that is not corrosive or scaling. Water that is not balanced can damage equipment and pool surfaces. See "Basic Water Chemistry" on page 37.

Proper water chemistry levels are essential to maintain safe and consistent swimming pool operation. Sanitizers are used to destroy harmful or otherwise objectionable organisms. Stabilizer or Cyanuric Acid (CYA) is used to prevent unnecessary loss of chlorine to sunlight. Salt is used by the Pool Pilot® to generate chlorine sanitizer.

The following recommended water chemistry parameters are for residential pool / spa applications only. Follow local regulatory guidelines for any commercial pool / spa applications.

Parameter	Units	POOL			SPA		
		Min	Ideal	Max	Min	Ideal	Max
Free Chlorine	ppm (mg/L)	1.0	2.0 - 4.0	5.0	2.0	3.0 - 4.0	10
Combined Chlorine	ppm (mg/L)	0.0	0.0	0.2	0.0	0.0	0.5
pH	-	7.2	7.4 - 7.6	7.8	7.2	7.2 - 7.8	7.8
Total Alkalinity	ppm (mg/L)	60	80 - 100	180	60	80 - 100	180
Calcium Hardness	ppm (mg/L)	150	200 - 400	1000	100	150 - 250	1000
Salt	ppm (mg/L)	2,000	3,500 - 4,500	**	2,000	3,500 - 4,500	**
Cyanuric Acid (stabilizer)	ppm (mg/L)	0	30 - 50	***	0	30 - 50	***

** Typically 6,000 ppm (mg/L) or less is recommended; unit can operate with levels as high as 35,000+ ppm (mg/L).

*** This is dictated by state or local codes but is typically 80 ppm (mg/L).

See "Basic Water Chemistry" and "Using the Saturation Index" sections later in this manual for further information concerning pool / spa water chemistry maintenance requirements. Refer to the "Troubleshooting" section for assistance with resolving low or high chlorine issues.

3.3 Owner / Operator Control Buttons, Check System Fault and Audible Alarm

This section assumes the installer has already programmed the system for specific site parameters, established proper water balance and pretreated water to 1-3 ppm (mg/L) chlorine. Should Celsius vs. Fahrenheit, language preference, or other owner options require modification, refer to the "Programming" section of this manual. See "Review of Main Menu Programming" on page 19.

The following is a brief explanation of owner or operator control buttons.

3.3.a UP and DOWN Arrows

Use the UP and DOWN (Δ or ∇) arrows to control the purifier output level. This is also used in conjunction with the MENU/ENTER button to step through the menu selections.

After output level is adjusted, press the MENU/ENTER button to save the value chosen. With a properly prepared pool, the recommended starting output level is 50%.

Upon initial start-up, check sanitizer every 3 - 4 days and make small output level adjustments as necessary to maintain 1 - 3 ppm (mg/L) free chlorine levels. Keep in mind, your Pool Pilot[®] does not directly measure or regulate the sanitizer levels in your pool. Rather, the owner / operator will need to periodically test the water to determine the current chlorine level and adjust the output setting as needed.

After the chlorine output level is "tuned in", the unit will automatically make fine output adjustments as water temperature fluctuates. This temperature compensation feature will adjust output depending on water temperature. See "Patented Temperature Compensation" on page 8.

Note: The optimum output setting will vary based upon pool size, location, exposure to sunlight, number of users, vegetation around the pool, water balance practices, and pump run time. Your installer should have already taken these factors into consideration when performing installation programming. Therefore, your adjustments, at this point, should be relatively minor.

3.3.b MENU/ENTER Button

The MENU/ENTER button allows the operator to choose program menu options. The owner / operator should not normally need to access these features on a regular basis. Consult the "Programming" section for additional information related to the menu options. See "Review of Main Menu Programming" on page 19.

Press to enter the Service Menu. Use the UP and DOWN (Δ or ∇) buttons to scroll through the menu and the MENU/ENTER button to select the function. The list of functions are as follows:

- Alarm On / Off
- Boost
- Set Reverse Time
- Replace a Cell
- Set Cell Power
- English / Metric
- Temperature Unit
- Installer Menu
- Exit Menu Mode

3.3.c On / Off Power Circuit Breaker

This main switch activates and deactivates the power going to the control center. The circuit breaker may trip when power surges occur. To reset, turn completely off and then back on.

3.3.d TEST Button (Diagnostic Menu)

Follow the instructions listed below to get accurate results.

1. If the unit is in the Boost mode, take the unit out of Boost mode.
2. Power the system off at the power breaker switch. Wait three (3) minutes for unit to completely discharge any remaining electricity to the cells.
3. Power on the unit and put back into the Boost mode or increase the Purifier to 100% output. Let the unit run for three (3) minutes.
4. Press TEST to initiate the test sequence. Record diagnostics information, including cell Amps and Volts, for each cell.
5. Deactivate Boost mode and return purifier output % to the original setting.

The unit will automatically sequence through various displays and then return to normal operation. You can also press the Δ or ∇ arrow to scroll forwards and backwards. Press the MENU/ENTER button again to skip the remaining displays and exit back to normal operation.

- Software Ver. X.x – Current version of the control board display software
- Power Setting – High/Low (Factory default is Low)
- Alarm – Enabled/Disabled (Factory default is Enabled)
- Reverse – # hrs. – The reverse rate programmed in the Installation Menu (Factory default is 4 hrs)
- Salt – ### ppm (#.# g/L) – The Tri-sensor salt reading. The optimum salt level is 3,500 ppm (mg/L), 4,500 ppm (mg/L) for efficient chlorine production
 - Add ## Salt (lbs.) – (Amount needed to maintain 3,000 ppm (mg/L))
- Water Temperature ##° F (##° C) – The temperature of the water flowing through the Tri-sensor
- Pool Volume - gallons (litres) – The pool volume programmed in the Installation Menu
- Cell x - ##V – Cell number and volts to the cell measured for each cell connected
 - ##### Amp-Hrs, and then
 - SW Ver: - #.##
- RS232 Enabled/Disabled - Factory use only and set to Enabled
- ATC Enabled/Disabled - Automatic Temperature Compensation feature. See "Patented Temperature Compensation" on page 8. Enabled is the factory default and cannot be changed

3.3.e WARNING Light and Audible Alarm

The WARNING light will flash to warn the unit may need attention. A warning message will also be displayed. If enabled, an audible alarm may also be heard when the system light is flashing. Unless deemed a normal condition per below, refer to the "*Troubleshooting*" section.

- Flashes red when pump is off / water flow is insufficient
- Flashes when salt is low (check salt and add as needed)
- Flashes when water temperature exceeds 125 °F (51 °C), or drops below 10 °F (-12 °C)

3.4 Normal Display Modes

Purifier Mode

Purifier (Chlorine Output %) level..... Shown in 1% increments

Water Temperature

Displayed in Fahrenheit or Celsius

Salt Level

Pool / spa water salt concentration level..... Shown in ppm (mg/L)

WARNING! Light

Off when operating normally. The Warning light will blink red when an error has occurred, such as for insufficient flow and low salt levels. See "Troubleshooting" on page 31.

SECTION 4 - SPECIFICATIONS AND APPROVALS

4.1 Specifications

For more information on sizing, see our Commercial Sizing Calculator on our website at <https://apservicecenter.com/sizing>

Model Designation	PPP-2	PPP-3	PPP-4	PPP-5	PPP-6
Max. Chlorine Output w / PPC5 Cell (lbs/day)	5.24 lbs/day (2.38 kg)	7.86 lbs/day (3.57 kg)	10.48 lbs/day (4.75 kg)	13.1 lbs/day (5.94 kg)	15.72 lbs/day (7.13 kg)
Max. Chlorine Output w / Convection Cell (no manifold) (lbs/day)	4.53 lbs/day (2.05 kg)	6.79 lbs/day (3.08 kg)	9.06 lbs/day (4.11 kg)	11.32 lbs/day (5.14 kg)	13.59 lbs/day (6.16 kg)
Rated Power in AC Amps	230 V/4.4 A	230 V/6.6 A	230 V/8.8 A	230 V/11.0 A	230 V/13.2 A
Minimum Water Flow Rate (gpm)	30 - 50 gpm (6.8 - 11.3 m ³ /hr)				
Maximum Water Flow Rate (gpm)	70 gpm (22.6 m ³ /hr)				
ORP Input (Dry contact)	10 mA typical (ORP controllers with 110 V output and multiple power supplies will require relay kit part #110-ORP: ORP Relay Box (110V US plug))				
Weight (Power Supply)	83 lbs.	91 lbs.	99 lbs.	107 lbs.	115 lbs.
Weight (Manifold)	10 lbs.	20 lbs.	20 lbs.	30 lbs.	30 lbs.
Convection Cells	10 lbs.	15 lbs.	20 lbs.	25 lbs.	30 lbs.

4.2 Manifold Pressure Drop vs Flow

The following chart shows pressure drop versus flow for Pool Pilot® Professional manifolds.

Pool Pilot® Professional Manifold Pressure Drop vs. Flow

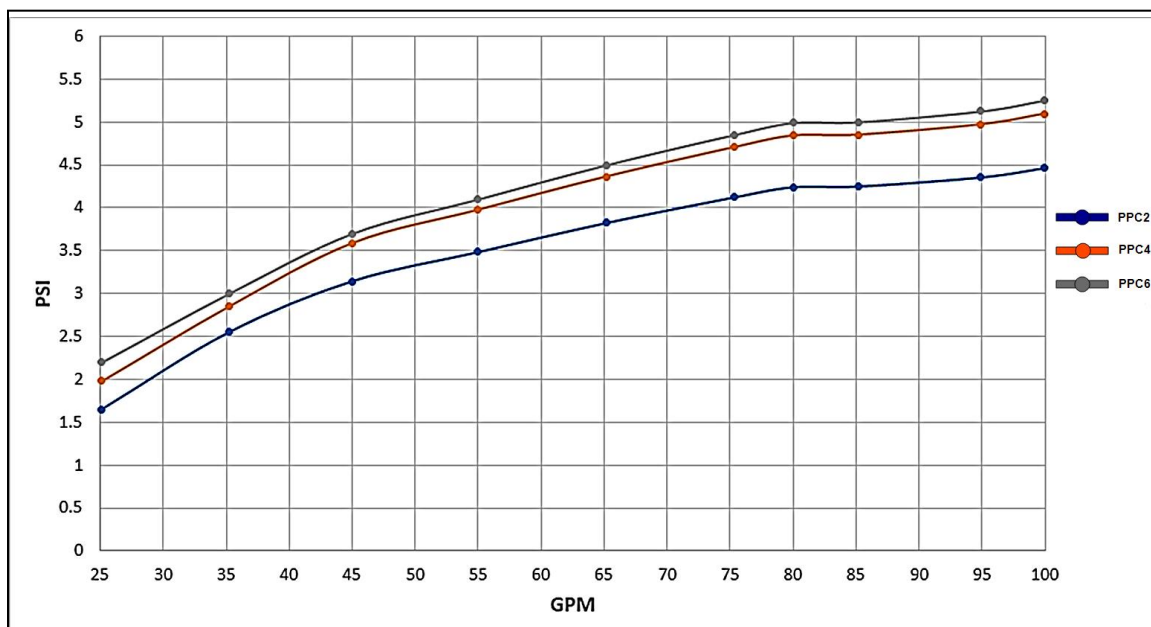

Figure 4

SECTION 5 - FEATURES

- Patented temperature compensation for chlorine output control
- Programmable microprocessor control
- Digitally controlled power to the cell
- Tri-sensor circuitry to monitor water flow, water temperature, and salt level
- Calculates and displays amount of salt needed to reach the recommended 3,000 ppm (mg/L) salt concentration level
- On board diagnostic and test programs
- Interface for connection to an external ORP controller

5.1 Patented Temperature Compensation

- ⚠ WARNING** - Failure to heed the following may result in permanent injury or death.
- Pool or Spa water temperature should not exceed 104 °F (40 °C).

The water temperature sensor works in conjunction with the purifier % feature to automatically adjust chlorine output based upon changes in water temperature. This feature operates between 55 °F and 125 °F (13 °C - 52 °C).

As water temperature falls below 65 °F (18 °C), the controller will reduce the maximum output % that can be selected. This feature prevents the controller from generating excessive chlorine in cold water where it is not needed and prevents premature cell failure.

At 55 °F (13 °C) or colder water temperatures the controller will adjust to a fixed 1% output, thus preventing over-chlorination and premature cell failure.

This feature is disabled when connected to an ORP controller and purifier output is set to 0%.

5.2 Water Manifold Assemblies - Available Options

5.2.a Automatic - Flow Bypass Manifold Assembly

The AutoPilot® manifold assembly is available with two (2), three (3), four (4), five (5), or six (6) cells, including the Tri-sensor. Each cell must have a corresponding power module.

Example: If you order a PPP- 4 unit, there will be four (4) power modules in the control center and a 941- 415AC manifold assembly with four (4) cells and one (1) Tri-sensor assembly.

The manifold is connected into the plumbing after all other equipment. Water from the pool / spa is moved through the manifold by the circulation pump. Ensure there is enough flow to the manifold base (min. 30 – 50 gpm / max. 70 gpm (min. 6.8 – 11.3 m³/hr / max. 22.6 m³/hr)).

The manifold uses four key components:

- The **Tri-sensor** provides data (from electronic sensors) to the Pool Pilot® for monitoring water flow, water temperature, and salt concentration level. The Pool Pilot® uses this data to determine if conditions are suitable for the cell to operate; the signal read from the temperature sensor allows the automatic temperature compensation feature to function.
- The **Cell** (PPCx) receives power from the Pool Pilot® and converts the salt contained in the water to chlorine.
- The **Strainer Screen** prevents debris in the water from entering the Tri-sensor or cell and requires periodic inspection and cleaning.
- The **Bypass Check Valve** allows the water flow rate to be slowed and optimized through the cell while permitting the pump to continue to circulate water to-and-from the pool / spa at full flow rates. The reduced water flow through the cell results in a more efficient "Super-Chlorination" effect, resulting in improved overall sanitization.

Pool Pilot® Professional Manifold Assembly Options

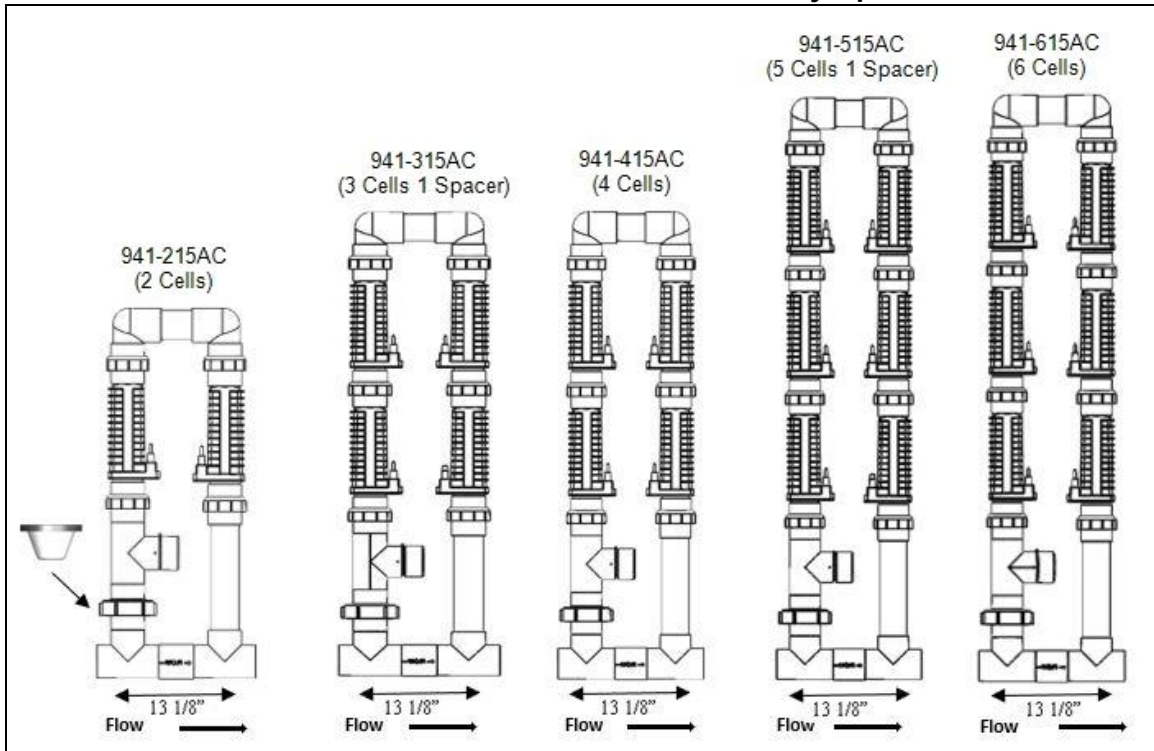

Figure 5

5.2.b Cell

The cell is installed with unions on each end of the cell to allow for quick and easy removal. To remove and inspect the cell, loosen the unions and remove from the plumbing assembly.



Figure 6

SECTION 6 - MAINTENANCE

6.1 Accessing the Power Module

WARNING - Failure to heed the following may result in permanent injury or death.

- **ELECTRICAL SHOCK HAZARD** – Turn off the electrical power at the main circuit breaker to the unit before servicing.

The power modules, which send power to the cell, are located inside the control center and mounted vertically as seen in the diagram below. The control center is capable of housing up to six (6) power modules. Follow the steps below to replace the fuse or power module as needed.

1. The front cover plate is secured by four (4) screws. Loosen all four (4) of the screws and remove the cover plate.
2. The power module angle flange is held by an “L” bracket. The “L” bracket has two screws on each end and each power module angle flange has a screw. Take out the screws on the end of the “L” bracket and on each power module angle flange.
3. Remove the “L” bracket from the power center cabinet.
4. Each module uses two (2) hold down screws to attach the power board angle flange to the back plate. Locations are shown below. Using a long shaft Phillips head screwdriver, loosen both screws but do not remove.
5. Remove the top wire assembly that connects to the main control panel and then the front cell cord wire connections.
6. Slide the power module up until the flange keyholes match the down screws and pull out until you can reach and disconnect the rear power connectors, then remove the power module.

Power Module

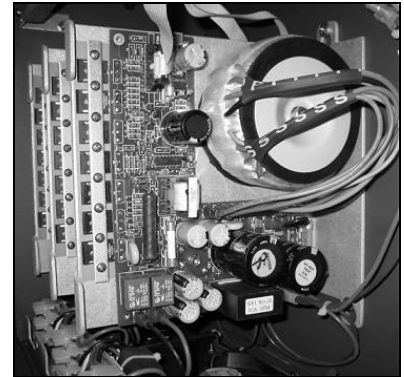

Figure 7

Professional Power Supply

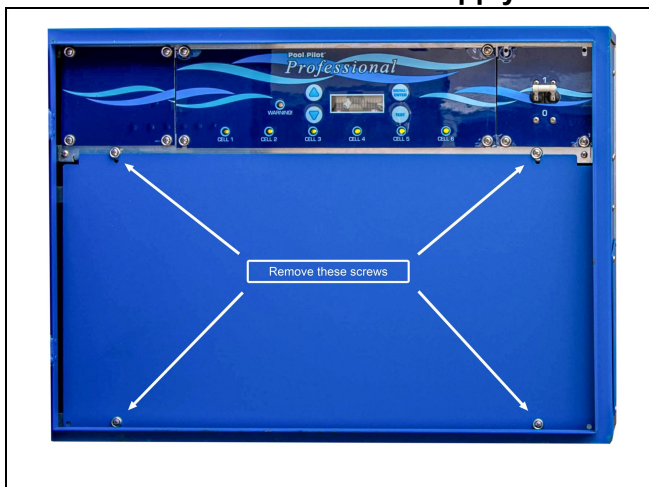

Figure 8

Power Module Location

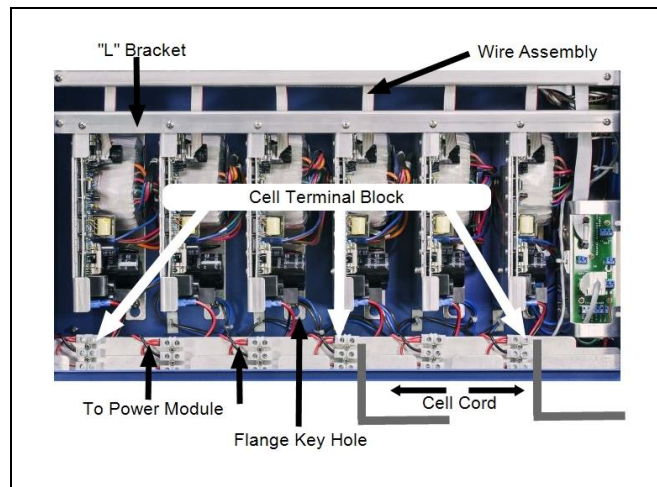

Figure 9

For a complete list of parts, visit www.autopilot.com.

6.2 Removing / Inspecting / Cleaning Tri-sensor

6.2.a Tri-sensor Assembly Overview

The Tri-sensor Assembly is used to measure water flow, salt level, and water temperature.

Note: The use of high strength magnet devices in the close proximity of the Tri-sensor can cause the flow switch to function incorrectly.

- When the water flow reaches a minimum flow rate of 20 gpm (76 L/min), the flow paddle magnet closes a micro-switch monitored by the Pool Pilot®.
- The Pool Pilot® uses dedicated salt sensor blades to measure the level of salt in the water.
- The Pool Pilot® uses the temperature sensor to determine water temperature. This measurement is required for the Patented Automatic Temperature Compensation feature to automatically adjust chlorine output as water temperature varies. Less chlorine is needed in cold water, so chlorine output is automatically reduced as water temperature drops (avoiding excess chlorine production). Conversely, more chlorine is needed in warmer water, and production is automatically adjusted higher as water temperature increases.
- Please note - The Tri-sensor normally does not require maintenance or cleaning.

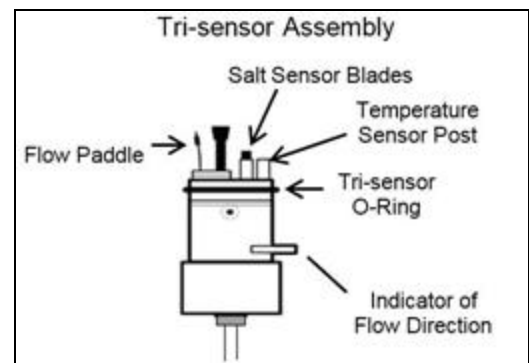

Figure 10

6.2.b Inspect Tri-sensor

1. Disconnect the Tri-sensor cable from the power center.
2. Remove the two (2) screws retaining the Tri-sensor in the Tee joint of the manifold.
 - Note the orientation of the Direction of Flow Tab. The Tri-sensor must be installed in the same orientation when it is reinstalled or replaced.
3. The Tri-sensor can now be pulled out of the Tee.

⚠ CAUTION - Failure to heed the following may result in equipment damage.

- The Tri-sensor should not be removed from manifold at an angle or the flow paddle and / or flow post may be damaged.
 - Firmly grip the Tri-sensor assembly (this is typically done with a large pair of channel lock pliers).
 - Twist the Tri-sensor back-and-forth while simultaneously pulling the Tri-sensor straight out of the Tee joint.
4. Check the Tri-sensor assembly for any damage to the plastic housing and replace if needed.
 5. Inspect the following on the flow switch:
 - Verify the thin metallic paddle is straight and free from erosion.
 - Verify the plastic post is straight and free of cracks. (Do not twist or bend the paddle or the plastic post.)
 6. Inspect the two salt sensor blades. The blades should not have any mineral deposits (scale) or other debris on them.
 - Do not use any metallic objects to scrape the blade surfaces or you will remove or damage the blade sensor coating.

6.2.c Cleaning Tri-sensor / Salt Sensor

If required, you can remove a calcium scale buildup by creating a solution of water and muriatic acid as follows. Do not use any metallic objects to scrape the blade surfaces or you will remove or damage the blade sensor coating.

⚠ WARNING - Failure to heed the following may result in permanent injury or death.

- CHEMICAL HAZARD - To avoid damaging splashes always add acid to water, never water to acid.
 - Wear appropriate personal safety protection, including safety glasses, when using pool chemicals.
1. Mix the solution in a small container tall enough to cover the sensor blades. DO NOT add water to acid; always add acid to water in container.
 2. Mix one (1) part muriatic acid into four (4) parts water.
 3. Immerse the salt sensor blades in the solution for up to fifteen (15) minutes. An effervescing action indicates the calcium is being dissolved from the blades.
 4. Rinse with fresh water and re-inspect. Repeat the acid treatment as necessary until all scale has been eliminated.

6.2.d Test Tri-sensor Flow Switch

⚠ WARNING - Failure to heed the following may result in permanent injury or death.

- Do NOT operate system with a faulty water flow switch.

The Flow Switch is a critical equipment protection device to prevent damage to the cell or system. When water flow has stopped, power to the cell is automatically turned OFF. It is important to verify the proper operation of the Tri-sensor's water flow switch protection device.

The following procedure can be used to verify the proper operation of the flow switch or to flush debris from the bypass valve.

1. Turn off the circulation pump.
2. Slightly loosen the union nut just below the cell on the side of the manifold that does not contain the filter screen. (A strap wrench may be required.)
3. Completely loosen the manifold union nut that contains the filter screen and pivot the manifold to gain access to the filter screen.
4. Remove the screen. Clean the screen if dirty.
5. If the screen was dirty, then the system may need to be purged to remove excess debris. Leave the manifold off and run the pump for a few seconds until clear.
6. Wrap the strainer screen securely with a small piece of plastic wrap (saran wrap, food wrap or zip lock bag) as indicated in the diagram and place it back in the union.
7. Tighten the two unions that were loosened. Do not over tighten.
8. Turn on the pump and the Pool Pilot®. The plastic will stop water flow to the flow switch, which is part of the Tri-sensor that is located right above the strainer screen. All water will be forced through the bypass valve. (This action will normally flush out any small bits of debris trapped in the bypass valve.)
9. The Pool Pilot® should detect a low water flow at the Tri-sensor and activate the red WARNING light. The unit will also display the message "!!! Warning !!! No flow".
10. If the unit did not display this warning, check the Tri-sensor cable connections and inspect and clean the Tri-sensor as outlined in the "Inspect Tri-sensor" and "Cleaning Tri-sensor" sections. If the warning message still does not appear, then turn the Pool Pilot® off and contact the factory or your local dealer for assistance.
11. Turn the pump off.
12. Loosen the unions.
13. Remove the plastic wrap and replace the strainer screen. Tighten the unions.
14. Resume normal operation.

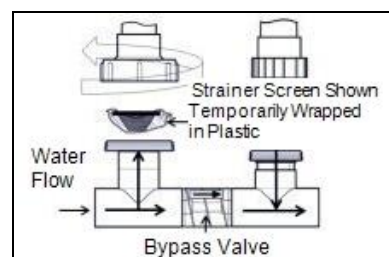

Figure 11

6.3 Servicing the Cell

The cells may require removal for periodic visual inspections, or for servicing when debris or calcium mineral deposits develop. The need to inspect and service the cells is indicated by the WARNING light flashing.

6.3.a Removal

The cells are installed with unions on each end to allow quick and easy installation and removal.

1. Turn off the circulation pump and shut off all power.
2. Unscrew the unions at both ends of each cell. (A strap wrench may be required.)
3. Slide the cell out of the manifold assembly.
4. Inspect the cell - **If cleaning is necessary, detach cell cord from cell.**

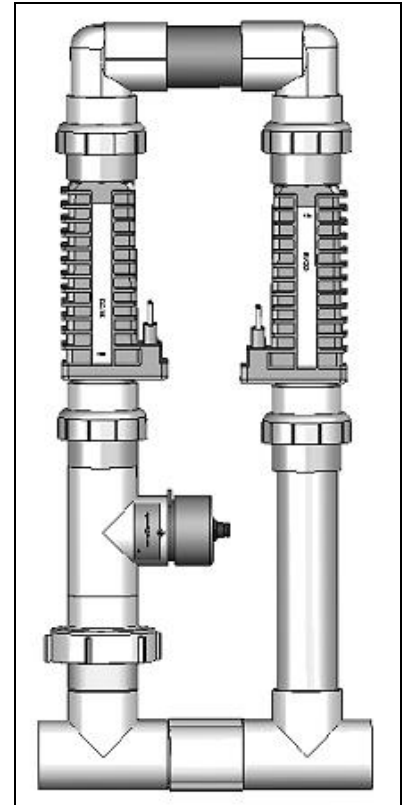

Figure 12

6.3.b Visual Inspection

Your Pool Pilot® is designed to automatically self-clean calcium scale build up that may form on the blades during normal operation. However, unbalanced water chemistry can cause a heavy scale build up exceeding self-cleaning capabilities... thus; periodic manual cleaning may be necessary. The simplest way to avoid this extra work is to maintain the water chemistry at the levels recommended according to the Saturation Index.

1. The cell titanium blades, seen inside the cell body, should be straight and clear of any debris on the ends or between the blades.
2. White flaky or crusty calcium build up on the edge or between the blades will shorten the life of the cell. If required, clean the cell immediately and determine the cause of scaling. See "Basic Water Chemistry" on page 37. See "Using the Saturation Index" on page 39.

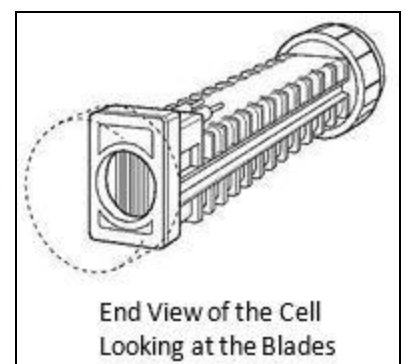

Figure 13

6.3.c Manual Cleaning

- ⚠ WARNING** - Failure to heed the following may result in permanent injury or death.
- **CHEMICAL HAZARD** - To avoid damaging splashes always add acid to water, never water to acid. Wear safety glasses and use other appropriate personal protection equipment.

- ⚠ CAUTION** - Failure to heed the following may result in equipment damage.
- Scraping or scratching the titanium blade's edge or surface will damage the blade catalyst coating and cause premature failure of the cell... warranty will be voided. Never use any sharp or metallic objects to remove scale.

1. Place a PLA0113 cell cleaning plug (AutoPilot® accessory) on the end of the cell as shown. A 1 ½" MPT clean out plug may also be used and can be purchased in the PVC plumbing section at most pool supply or home improvement stores.
2. Fill the capped cell with water two (2) inches from the top of the cell blades.
3. Fill the rest of the cell with muriatic acid. This allows for an approximate 1-to-4 solution. Always add the acid to the water. If you do it the other way around, it can cause the solution to spray back causing serious injury.
4. Allow the solution to sit in the cell for fifteen (15) minutes or until the acid stops bubbling.
5. Safely dispose of the solution; pouring it into the pool is recommended.
6. Remove the cap and rinse the cell with light water pressure; re-inspect the cell and repeat acid cleaning if the cell is still scaled.

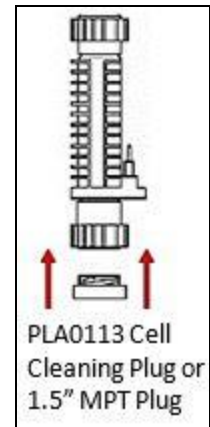

Figure 14

6.3.d Installing

- ⚠ CAUTION** - Failure to heed the following may result in equipment damage.
- The electrical terminals must be completely dry to avoid corrosion and failure of the cell or cable.
 - Ensure that the cell cable is fully engaged. A partially seated cable may result in damage to the cable or cell during operation.

1. Clean and dry the electrical pins on the cell. The contacts must be completely dry to avoid corrosion and failure of the cell or cable.
2. Ensure the union o-rings are in place; then place the cell into the manifold with cell pins pointed upward. See Figure 12.
3. If necessary, use water to rinse away any dirt and debris on the union and then tighten the unions by hand for a watertight seal. The cell cable has three (3) electrical contact pins. Align the cable and terminals and connect them together.
4. Turn on the system.
5. Check for leaks and proper operation.

6.4 Winterizing

- ⚠ CAUTION** - Failure to heed the following may result in equipment damage.
- Special measures are required in the event of freezing conditions. The Pool Pilot® may be damaged if measures are not taken in advance of freezing conditions. Equipment damage due to freezing conditions is NOT covered under the equipment warranty.

During brief freezing conditions, allow the filtration system to run continuously throughout the freeze period. Circulating (moving) water will not freeze.

In areas where freezing conditions are prevalent and sustained, the equipment must be winterized as follows:

Control Unit and Manifold Assembly

- Turn off power to the control center at the circuit breaker. Turn off power to the main filtration pump.
- Drain all water from the manifold assembly (cell and Tri-sensor), pump, filter, supply and return lines prior to freezing weather.
- If desired, AutoPilot® plug kit #996 may be purchased to cover the openings. The manifold assembly, including the cell, Tri-sensor and cables may be stored indoors.
- The control unit is not affected by the cold and does not need to be removed.

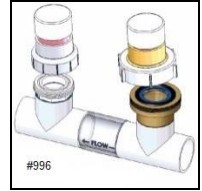

Figure 15

6.5 Spring Start Up

It is recommended the water be manually chlorine-shocked when first starting up the pool in the springtime. Test water and add the appropriate chemicals to balance the pool water per the levels recommended in this manual. See "Water Balance and Chemistry Recommendations" on page 4. Be sure to check salt and Cyanuric acid (stabilizer), bringing those readings up to the recommended levels. It is also a good idea to inspect the cell, manifold screen, and test the Tri-sensor flow switch; clean and/or replace those items as necessary. See "Removing / Inspecting / Cleaning Tri-sensor" on page 11. See "Servicing the Cell" on page 13.

SECTION 7 - PROGRAMMING

7.1 Control Panel

7.1.a Button Overview

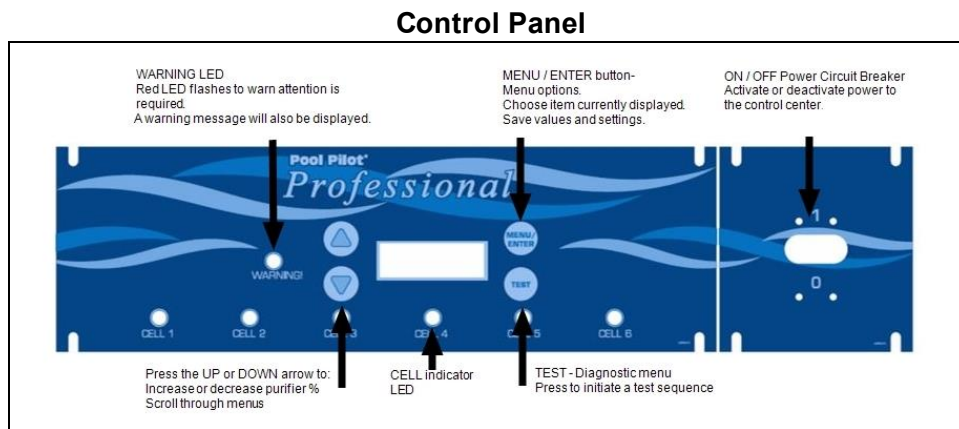

Figure 16

7.1.b On / Off Power Circuit Breaker

This main switch activates and deactivates the power going to the control center.

When an extreme power overcurrent occurs, the circuit breaker will trip to the off ("0") position. To reactivate, turn completely off by making sure both sides of the switch are in the down position. Turn the unit back on by flipping the switch up to the on ("1") position .

7.1.c Up or Down (Δ / ∇) Buttons

Use the Δ or ∇ buttons to either increase or decrease the purifier output level. This is also used in conjunction with the MENU/ENTER button to step through the menu selections.

7.1.d MENU/ENTER Button

The MENU/ENTER button allows the operator to choose and set program menu options. The owner / operator should not normally need to access these features on a regular basis.

Press to enter the menu options. Use the Δ or ∇ buttons to scroll through the menu and the MENU/ENTER button to select the desired function.

7.1.e TEST Button (Diagnostic Menu)

A program and parameter menu used to view the currently programmed settings.

The unit will automatically sequence through various displays and then return to normal operation. You can also press the Δ or ∇ button to scroll forwards and backwards. Press the MENU/ENTER button again to skip the remaining displays and exit back to normal operation.

Follow the instructions listed below to get accurate results.

1. If the unit is in the Boost mode, take the unit out of Boost mode. See "Review of Main Menu Programming" on page 19.
2. Power the system off at the power breaker switch. Wait three (3) minutes for unit to completely discharge any remaining electricity to the cells.
3. Power on the unit and put back into the Boost mode or increase the Purifier to 100% output. Let the unit run for three (3) minutes.
4. Press TEST to initiate the test sequence. Record diagnostics information, including Cell Amps and Volts for each cell.
5. Deactivate Boost mode and return purifier output % to the original setting.

The display will automatically sequence through the following information and then return to normal operation. You can also press Δ or ∇ to scroll forwards and backwards. Press the MENU/ENTER button again to skip the remaining displays and exit back to normal operation.

- Software Ver. X.x – Current version of the control board display software
- Power Setting – High / Low (Factory default is Low)
- Alarm – Enabled / Disabled (Factory default is Enabled)
- Reverse – # hrs. – The reverse rate programmed in the Installation Menu (Factory default is 4 hours)
- Salt – #### ppm (#.# g/L) – The Tri-sensor salt reading. The optimum salt level is 3,500 ppm (mg/L), 4,500 ppm (mg/L) for efficient chlorine production
 - Add ## Salt (lbs.) – (Amount needed to maintain 3,000 ppm (mg/L))
- Water Temperature ##° F (##° C) – The temperature of the water flowing through the Tri-sensor
- Pool Volume - gallons (litres) – The pool volume programmed in the Installation Menu
- Cell x - ##V – Cell number and volts to the cell measured for each cell connected
 - ##### Amp-Hrs, and then
 - SW Ver: - #.##
- RS232 Enabled / Disabled - Factory use only and set to Enabled
- ATC Enabled / Disabled - Automatic Temperature Compensation feature. See "Patented Temperature Compensation" on page 8. Factory default is Enabled and cannot be changed

7.1.f WARNING Light and Audible Alarm

The WARNING light will flash to warn the unit may need attention. A warning message will also be displayed. If enabled, an audible alarm may also be heard when the system light is flashing. Unless deemed a normal condition per below, refer to the "Troubleshooting" section.

- Flashes red when pump is off / water flow is insufficient
- Flashes when salt is low (check salt and add as needed)
- Flashes when water temperature exceeds 125 °F (51 °C), or drops below 10 °F (-12 °C)

Note: When enabled, an audible alarm will sound due to any of the above three (3) conditions.

7.1.g Cell Indicator Lights

There are six (6) cell indicator lights on the control panel. The lights flash as the processor communicates to each specific cell. They will show solid green when a cell is generating chlorine. The light will not be illuminated if the cell is not generating chlorine at that time or if there is not a corresponding cell to that position.

Note: Wherever there is no cell connected to the control center, the display will show “CELL X not found”.

7.1.h Display Overview

The first line of the display typically indicates purifier (chlorine) output level in percentage (%), or whether the system is in Boost mode with hours remaining.

The second line will show the following information:

- The temperature in either °F or °C will be shown
- “On” in the lower right corner will indicate whether the cell is generating chlorine
- A small dot in the bottom right corner indicates the self-cleaning forward / reverse cycle
- Salt level in ppm (mg/L)

7.2 Basic Operational Programming

7.2.a Adjusting the Purifier Output %

Typically, once the initial setting is established, very little adjustment is needed. The Purifier output % setting refers to the amount of time the cell is energized within a fifteen (15) minute cycle. The system cycles on-and-off as indicated on the display's lower right display and “On” when generating chlorine. Higher settings will generate more chlorine.

1. Use the Δ or ∇ buttons to adjust the purifier (chlorine) output percentage to the desired output: from 0% (off) to 100 % ; then press MENU/ENTER to save the new output value and default back to the normal display. At start up of a new system, the standard output setting starting point is 50%.

50% setting = 50% of 15 minutes or 7.5 minutes ON and 7.5 minutes OFF

25% setting = 3.75 min ON, 11.25 min OFF

Once the percentage is set, the unit will implement the temperature compensation algorithm based on current water temperature.

7.2.b Boost

The Boost feature is used to increase the purifier % from its normal setting to 100% for a cumulative amount of time between one (1) and seventy two (72) hour period of pool pump run time. When the Boost period expires or is manually terminated, the purifier % returns to its previous setting and normal operation.

1. From the normal operation mode, press the MENU/ENTER and use the ∇ arrow until Boost appears.
2. Press the MENU/ENTER to enter the Boost menu.
3. Use the Δ or ∇ until the desired amount of time is shown and press MENU/ENTER to select the value. When complete, the unit will automatically advance to the next menu option.

To cancel the Boost function:

1. From the normal operation mode, press the MENU/ENTER and use the ∇ arrow until Boost appears.
2. Press the MENU/ENTER to enter the Boost menu.
3. Use the ∇ arrow until Off is shown. Press MENU/ENTER to save.

If an external time clock or controller turns off power to the chlorinator while Boost is active, the Boost timer is stored in memory and the Boost time countdown will resume when power is reapplied to the unit.

If water flow is stopped during a Boost cycle, chlorine generation will stop while there is no flow but the Boost timer will continue to count down as long as the Pool Pilot® has power.

7.2.c Purifier Mode

The Pool Pilot® will automatically display informative messages about the condition of the unit (purifier output %, water temperature, warning messages, etc.), and responds to manual adjustment of purifier % setting (as described below). The unit will revert to the normal display if there is no activity on the keypad for thirteen (13) or more seconds.

7.2.d Purifier % Adjustment Procedure

1. Balance water chemistry according to necessary water chemistry parameters. See "Basic Water Chemistry" on page 37. For new start ups, if free chlorine level as tested is not at least 1 ppm (mg/L), manually add and adjust chlorine levels to ensure 1 - 3 ppm (mg/L) free chlorine reading.
2. Add the proper amount of salt as indicated on the display and run the circulation pump continuously for 24 hours, allowing the salt to be fully mixed and dissolved into the pool. Since your Pool Pilot® runs in conjunction with the main filter pump so that whenever the pump and circuit breaker are on, the display will be on to indicate power is being sent to the control panel. The display will show the setting to which the unit is adjusted. The GREEN cell lights will be on whenever that cell is energized to produce chlorine. If the salt level is too low, the Pool Pilot® will provide a warning and will not generate chlorine until the minimum salt level has been reached.
3. Use the Δ or ∇ buttons to set the purifier % to 50% and then allow the pool to operate normally.

For the first two weeks, test the water chemistry parameters every 3 - 4 days. Adjust chemicals as needed to maintain correct water balance. For the Free Chlorine adjustment, use the following table for fine-tuning the controller output percentage (%):

PURIFIER SET TO:	IF FREE CHLORINE IS LOWER THAN IDEAL RANGE...	IF FREE CHLORINE IS HIGHER THAN IDEAL RANGE...
1% - 25%	<p>The purifier output % needs to be increased.</p> <ul style="list-style-type: none"> • Use the Δ button to increase the purifier output %. Press MENU/ENTER to lock in change. The free chlorine will need to be tested frequently and the purifier % output will need to be adjusted as needed to attain desired level 	<p>If the Cell Power is set to High, switch to Low.</p> <ol style="list-style-type: none"> 1. Decrease the Cell Power one level to lower the maximum output %. 2. Use the Δ or ∇ buttons to set the Purifier output to 50%. The free chlorine should be tested frequently and Purifier adjusted as needed to maintain desired level.
25% - 75%	<p>The purifier % output needs to be increased.</p> <ul style="list-style-type: none"> • Use the Δ button to increase the purifier output %. Press MENU/ENTER to lock in the change. 	<p>The purifier output % needs to be decreased.</p> <ul style="list-style-type: none"> • Use the ∇ button to decrease the purifier output %. Press MENU/ENTER to lock in change.
75% - 100%	<p>If the Cell Power is set to Low, switch to High.</p> <ol style="list-style-type: none"> 1. Increase the Cell Power one level to raise the maximum output %. 2. Use the Δ or ∇ buttons to set the Purifier output to 50%. The free chlorine should be tested frequently and Purifier adjusted as needed to maintain desired level. 	<p>The Purifier output setting may be too high.</p> <ul style="list-style-type: none"> • Use the ∇ button to lower output %. Press MENU/ENTER to lock in change. The free chlorine will need to be tested frequently and the purifier % output will need to be adjusted as needed to attain desired level.

After the optimal output percentage (%) has been determined, this setting will not normally require further adjustment. Select a Boost cycle to compensate for increased bather usage or heavy rainfalls (which can both quickly consume chlorine).

7.3 Review of Main Menu Programming

Once programmed for the installation site, the following menu items should not require regular access. See "Basic Operational Programming" on page 17.

After completing a function, the next function in sequence will be displayed for selection. This does not apply to those functions that exit service mode upon completion such as Force Reverse and Calibrate Salt.

7.3.a Enable / Disable Audible Alarm

The alarm will sound when there is no flow or low salt. Entering TEST or MENU/ENTER will temporarily silence the alarm. The alarm can be silenced by turning the power off or by selecting "Alarm Disabled", but will sound again once power is restored.

Note: If alarm is due to low or no water flow, the alarm will automatically silence in 10 minutes. Upon restoration of flow, normal Audio Alarm operation will resume.

1. Press MENU/ENTER, press ∇ until "Alarm on/off" is displayed, then press MENU/ENTER.
2. Press Δ or ∇ until "Alarm Enable" or "Alarm Disable" is displayed, then press MENU/ENTER to select desired option. When complete, the unit will automatically advance to the next menu option.

7.3.b Boost

The Boost feature is used to increase the purifier % from its normal setting to 100% for a cumulative amount of time between one (1) and seventy two (72) hour period of pool pump run time. When the Boost period expires or is manually terminated, the purifier % returns to its previous setting and normal operation.

1. From the normal operation mode, press the MENU/ENTER and use the ∇ arrow until Boost appears.
2. Press the MENU/ENTER to enter the Boost menu.
3. Use the Δ or ∇ until the desired amount of time is shown and press MENU/ENTER to select the value. When complete, the unit will automatically advance to the next menu option.

To cancel the Boost function:

1. From the normal operation mode, press the MENU/ENTER and use the ∇ arrow until Boost appears.
2. Press the MENU/ENTER to enter the Boost menu.
3. Use the ∇ arrow until Off is shown. Press MENU/ENTER to save.

If an external time clock or controller turns off power to the chlorinator while Boost is active, the Boost timer is stored in memory and the Boost time countdown will resume when power is reapplied to the unit.

If water flow is stopped during a Boost cycle, chlorine generation will stop while there is no flow but the Boost timer will continue to count down as long as the Pool Pilot® has power.

7.3.c Set Reverse Time

Program cell's self-cleaning cycle.

 CAUTION - Failure to heed the following may result in equipment damage.

- Reduced polarity reversing cycle times will reduce cell life and should only be used due to uncontrollable scale formation on the cell. Always test and adjust water balance before attempting scale control via shortening reverse period. See "Using the Saturation Index" on page 39.
1. Press MENU/ENTER, press Δ or ∇ until "Set Reverse Time" is displayed, then press MENU/ENTER.
 2. Press Δ or ∇ until the desired cycle time (1- 4, 6, 8, 12 or 16 hours) is displayed, then press MENU/ENTER. The unit will automatically advance to the next menu option.

7.3.d Force Reverse

Program the cells to activate a force reverse cycle and verify if the system is reversing polarity (self-cleaning). This is a diagnostic tool only and should not be used unless a problem is suspected.

1. Press MENU/ENTER, press Δ or ∇ until "Force reverse" is displayed, then press MENU/ENTER.
2. "Cell reversing / " will be displayed for forty (40) seconds. When complete, the unit will automatically advance to the next menu option.

7.3.e Replace a Cell

This function is used to zero the accumulated ampere-hours when a cell is replaced.

1. Press MENU/ENTER, press Δ or ∇ until "Replace Cell" is displayed and press MENU/ENTER.
2. The display will show "Cell x". Press Δ or ∇ until the desired cell to be replaced is shown and press MENU/ENTER.
3. Press the MENU/ENTER button to reset the ampere-hour counter. The unit will automatically advance to the next menu option.

7.3.f Set Cell Power

The Pool Pilot® Professional is equipped with two power level options. Your pool service professional will determine which power level best suits the sanitizing requirements for the body of water. The factory setting is Low.

1. Press MENU/ENTER, press Δ or ∇ until "Set Cell Power" is displayed and press MENU/ENTER.
2. Press Δ or ∇ until the desired cell power (High or Low) is shown and press MENU/ENTER. The unit will automatically advance to the next menu option.

7.3.g English/Metric (units)

Used to program the operator's personal preferences for liquid and weight measurements that the Pool Pilot® will display. The unit will show lbs/gallons for English, and kg/liters for metric.

1. Press MENU/ENTER, press Δ or ∇ until "English/Metric" is displayed and press MENU/ENTER.
2. Press Δ or ∇ until the desired option is shown ("English units" is the factory setting) and press MENU/ENTER. The unit will automatically advance to the next menu option.

7.3.h Set Temperature Unit

Set personal preference for temperature display units (°C or °F).

1. Press MENU/ENTER, press Δ or ∇ until "Temperature unit" is displayed, then press MENU/ENTER.
2. Press Δ or ∇ until desired measurement unit "Fahrenheit" or "Celsius" is displayed, then press MENU/ENTER. The unit will automatically advance to the next menu option.

7.4 Review of Installer Menu Programming

7.4.a Calibrate Temperature

You must wait a full two minutes after start up to calibrate temperature. Used only when it is desired to match the display of the Pool Pilot® to another on-site thermometer.

1. Press MENU/ENTER, press ▽ until "Installer menu" is displayed and press MENU/ENTER.
2. Press ▽ until "Calibrate temp." is displayed and press MENU/ENTER.
3. Press △ or ▽ until the desired temperature is shown, then press MENU/ENTER. The maximum adjustment is $\pm 6^{\circ}\text{F}$ ($\pm 3^{\circ}\text{C}$).
4. Press △ or ▽ until "Exit Menu Mode" is displayed and press MENU/ENTER.

7.4.b Calibrate Salt

The unit has been calibrated at the factory and should not require further adjustments. In the event the salt display does not match on-site test results, follow these steps (it is necessary to wait 2 minutes after water flow has started before calibrating salt):

1. Press MENU/ENTER, press ▽ until "Installer Menu" is displayed and press MENU/ENTER.
2. Press ▽ until "Calibrate salt" is displayed and press MENU/ENTER.
3. Press △ or ▽ until the number on the display matches the accurately measured pool sample, press MENU/ENTER. The maximum adjustment is $\pm 1,000$ ppm (mg/L).
4. Press △ or ▽ until "Exit Menu Mode" is displayed and press MENU/ENTER.

7.4.c Set Pool Volume

The pool volume must be programmed for the "Add salt ### lb (kg)" display to be accurate. See "Calculating Pool Volume" on page 25.

1. Press MENU/ENTER, press ▽ until "Installer menu" is displayed.
2. Press ▽ until "Set pool volume" is displayed, press the MENU/ENTER.
3. Factory setting is 000 gallons (000 Liters). The range is 000 to 1,000,000 gallons (000 to 4,000,000 Liters).
4. Press △ or ▽ until correct pool size is displayed, press MENU/ENTER.
5. Press △ or ▽ until "Exit Menu Mode" is displayed and press MENU/ENTER.

SECTION 8 - INSTALLATION

8.1 Basic System Overview

The Pool Pilot® salt chlorination system is designed to operate in the following configurations:

Shown with automatic flow bypass manifold assembly 941-615AC:

Figure 17

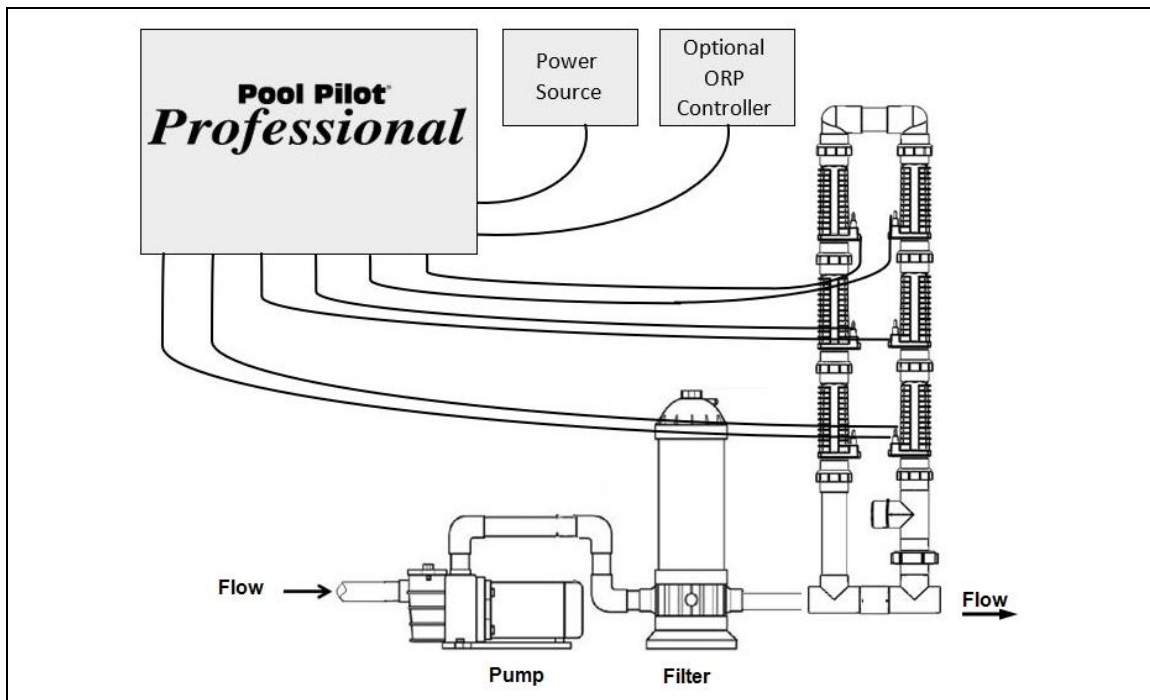

Shown with the convection cell option (surge tank required).

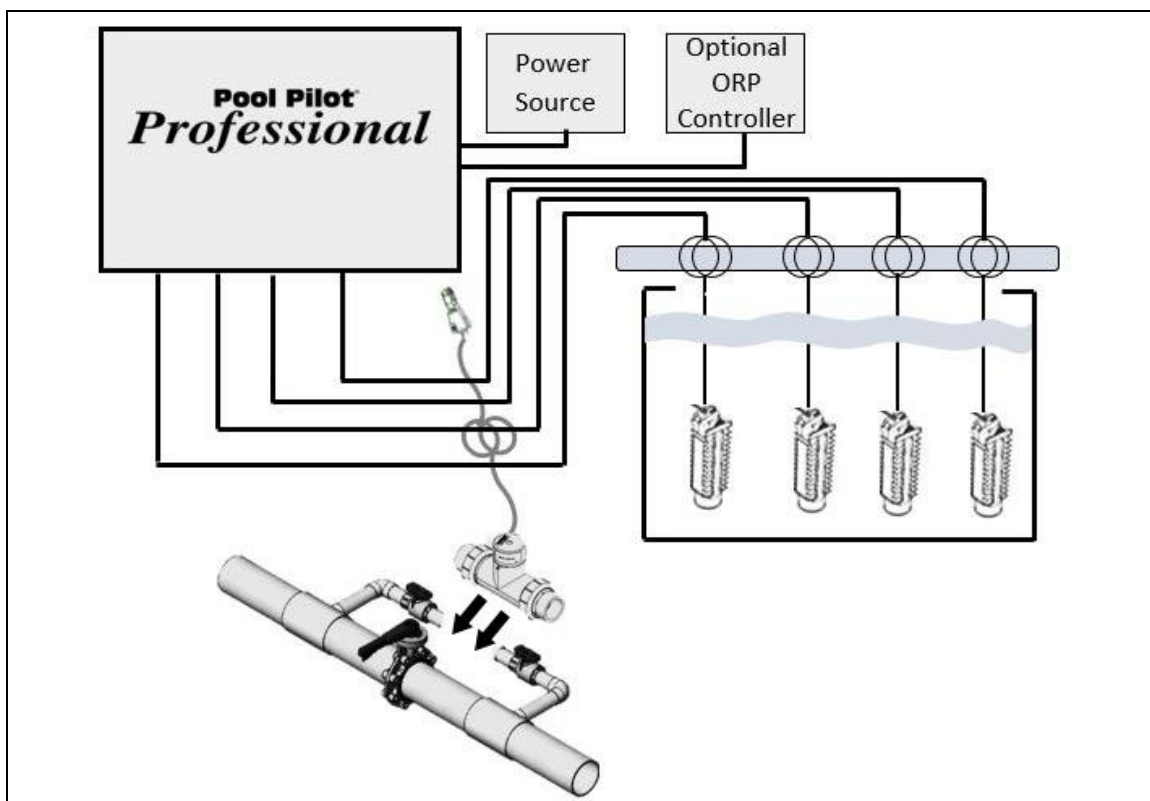

8.2 Planning the Installation

Before installing your Pool Pilot®:

1. Determine everything needed for installation is on hand.
2. Determine where the manifold assembly will be plumbed or surge tank located for convection cells, if applicable.
3. Identify a suitable mounting location for the Pool Pilot® control center that is close enough, less than 12 ft. (3.6 m), to ensure that the cell cord and Tri-sensor cord will reach the manifold components (or control center for convection cell applications) with some slack in the cords. The control center should be away from excessive heat, moisture and chemical exposure.
4. Plan wire runs and wiring connections for the 220-240V source power.
5. Plan the routing for the cell and Tri-sensor cables.
6. Determine origination point for the Pool Pilot® control center power feed:
 - a. Directly from a circuit breaker. (Circuit breaker is used to power the Pool Pilot®.)
 - b. From an external timer or an electronic controller. (Pool Pilot® is to be wired to the same location as the circulation pump; the unit is activated when the circulation pump is energized.)
7. Determine whether the Pool Pilot® will be controlled by an ORP controller or by an electronic controller system.

8.3 Installation Steps

Details on each step of the installation process are presented on the following pages:

1. Mounting the Pool Pilot® (See "Mounting the Control Center" on page 23.)
2. Electrical Connections (See "Electrical Connections" on page 28.)
 - Electrical Connections Overview
 - AC Input Voltage
 - High Voltage Wiring
 - Low Voltage Wiring
 - Connecting the Cell Cord
 - Connecting the Tri-sensor
 - Bonding
3. Plumbing the System (See "Plumbing the System" on page 24.)
4. Preparing the Water (See "Preparing the Pool Water" on page 25.)
5. Programming at Installation (See "Programming at Installation" on page 27.)

8.4 Mounting the Control Center

ATTENTION: As recommended in the *Planning the Installation* section, make sure there will be adequate cable length between the control center and the manifold (or Tri-sensor) before mounting the power supply and plumbing the manifold assembly. The Tri-sensor and cell cables are 12 ft (3.6 m) long. The selected location should allow easy access for service and maintenance.

- ⚠ WARNING** - Failure to heed the following may result in permanent injury or death.
- All electrical connections should be made by a licensed electrician or certified electrical contractor.
 - Disconnect all AC power when installing or servicing this system. Follow all state, local, and National Electrical Code(s) (provincial and Canadian Electrical Code(s) if applicable) unless local guidelines supersede.

The Pool Pilot® is suitable for indoor or outdoor mounting. When connected to 230 Vac, the Pool Pilot® control center must be installed at least 10 ft (3 m) horizontal distance from the pool or spa wall. Greater distances may be required by local codes.

Do not mount the Pool Pilot® control center inside a panel or a tightly enclosed area lacking proper and full ventilation. The enclosure is designed to allow heat to dissipate from inside the box. It is important the top or bottom of the enclosure is not blocked and there is space behind the control center to allow for adequate ventilation.

⚠ CAUTION - Failure to heed the following may result in equipment damage.

- Due to the weight of the control center, it is recommended to have another person assist you when marking and mounting the wall.

The Pool Pilot® control center is designed to mount vertically on a flat surface with the wiring inputs facing downward. Failure to mount the control center properly may result in the dislodging of the unit, resulting in serious injury. To avoid damage to wiring and connectors, read the following section before proceeding:

- The control center should be set on a vertical surface, away from excessive heat, moisture and chemical exposure.
- The mounting brackets should be secured to a solid wall surface or wall stud.
- Allow a clear area for the front access door to open completely as well as right side access to the electrical box for service and maintenance.

8.5 Plumbing the System

The Manifold Assembly has 2" PVC slip socket connections. Metric PVC adapters, 2" spigot x 63 mm socket, are provided with metric manifold models that have an "M" suffix such as PPMxM. The manifold is plumbed into the pool return line after the heater, if applicable.

For convection cell applications, a surge / water collection tank is required in place of the manifold assembly.

8.5.a Plumbing the Manifold Assembly

Select the location for installing the manifold:

- It is recommended to select a secure location for the Pool Pilot® control center prior to plumbing the manifold. The unit must be installed close enough to the manifold assembly to allow the Tri-sensor and cell cord sufficient slack to enable service and maintenance of the system. The cords are 12 ft (3.6 m) long.
- The bypass manifold / cell assembly (model 941-xxx) must be installed in a vertical orientation. This orientation prevents hazardous gas buildup in the system should the flow switch fail to detect sufficient flow. See "Basic System Overview" on page 22.
- The direction of the water flow through the manifold must be as indicated for the system to operate.

8.5.b Plumbing for Convection Cell Applications

- It is recommended the surge / water collection tank be planned prior to installation of the Pool Pilot® control center. The unit must be installed close enough (within 12 ft (3.6 m)) to the surge / collection tank for the Tri-sensor and cell cords to reach without excessive tension on the cords.
- The Tri-sensor should be installed in a bypass configuration, after filtration, and close enough for the cord to easily reach the control center. See "Basic System Overview" on page 22.
- The convection cells should be submerged with a minimum clearance of 6 inches (15.2 cm) below the water line and 6 inches (15.2 cm) above the bottom of the water tank. See "Basic System Overview" on page 22.

8.5.c Flow Rates 20 – 70 gpm (76 – 265 L/min)

- The manifold can be directly plumbed (vertical position) into the system.
- If the flow rate for the system is less than 20 gpm (76 L/min), a larger pump must be installed (or steps taken to improve flow rate).
- For a variable speed pump, ensure the pump can provide sufficient flow at the low speed.

Flow Rates Exceeding 70 gpm (265 L/min)

- A bypass must be installed on systems with flow rates exceeding 70 gpm (265 L/min).
- Manifolds are to be installed in a vertical (upright) position ONLY.

Bypass w / Tri-sensor
(Convection Cell Application)

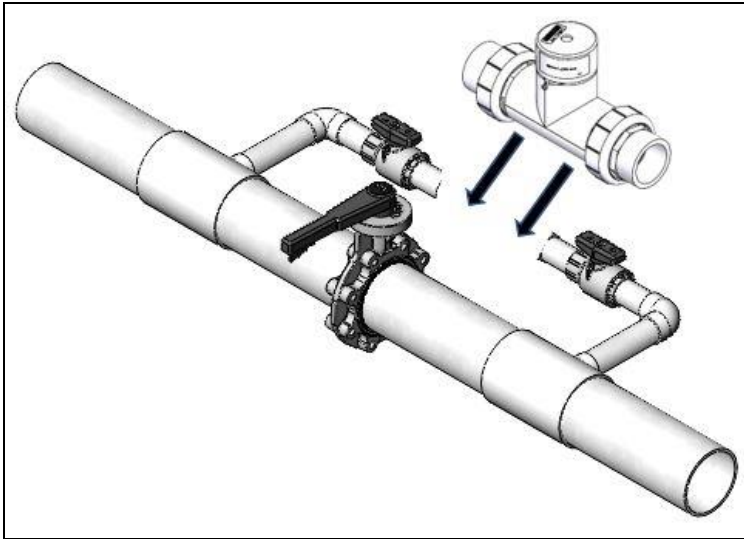

Figure 19

Manifold Assy with Bypass

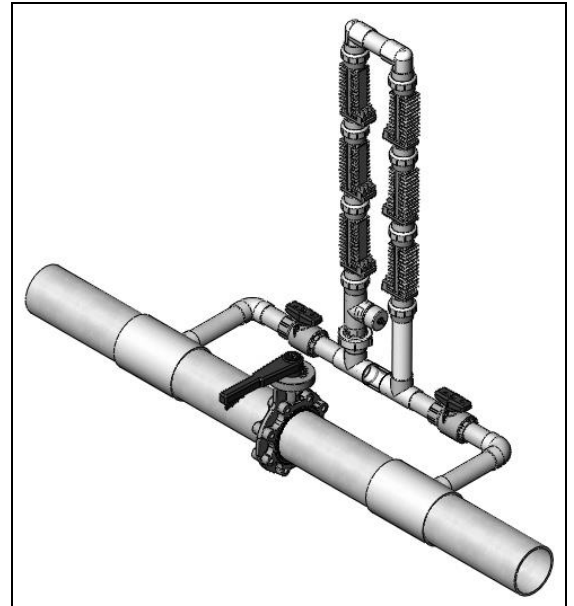

Figure 18

8.6 Preparing the Pool Water

Installer please note - When properly sized to the site, the Pool Pilot® will meet the sanitizer “maintenance” requirements of the pool / spa. The unit is not designed to chlorine shock treat or build up a chlorine residual when starting with a zero or very low chlorine level.

Before starting the chlorinator, the water must be properly balanced and the chlorine level adjusted to between 1 - 3 ppm (mg/L) free chlorine. More on adjusting water balance and start-up chlorine levels follows below.

8.6.a Calculating Pool Volume

To determine the approximate number of gallons or liters in a pool or spa:

1. Determine the surface area.
2. Multiply the surface area by the average depth and the constant conversion factor of 7.5 to convert cubic feet to gallons, or 1,000 to convert from cubic meters to liters.

Rectangle

- Area = Length x Width
- Gallons = area x average depth (ft³) x 7.5
- Liters = area x average depth (m³) x 1,000

Circular

- Area = Radius x Radius x 3.14
- Gallons = area x average depth (ft³) x 7.5
- Liters = area x average depth (m³) x 1,000

To determine the approximate number of gallons or liters in a more complex shaped pool:

1. Divide the complex shape into several simple shapes.
2. Calculate each one separately, and then add back together.

Example: An oblong pool can be divided into two radius measurements and one rectangular shape. (R = Radius)

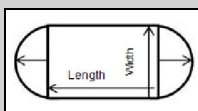

- Area = Radius x Radius x 3.14 + (Length x Width)
- Gallons = area x average depth (ft³) x 7.5
- Liters = area x average depth (m³) x 1,000

8.6.b Steps to Prepare Water

1. Calculate pool volume.
2. Add salt to water (test the water for salt level first). Adjust to 3,500 – 4,500 ppm (mg/L). See "Salt Addition Chart" on page 40.
3. Balance pool water. Add chemicals to adjust pool or spa water chemistry parameters as indicated. See "Water Balance and Chemistry Recommendations" on page 4. See "Using the Saturation Index" on page 39. If the saturation index indicates that the pool water is corrosive or scaling, then adjustments to the water chemistry should be made.
4. Add initial chlorine dosage. Use sufficient chlorine as obtained from pool supply center to achieve 1-3 ppm (mg/L), or local commercial guidelines, of free chlorine.
5. Enter pool volume information into the chlorinator. See "Set Pool Volume" on page 21.

8.6.c Adding Salt

Type of Salt to Add

It is important to use Sodium Chloride (NaCl) salt that is greater than 99% pure. Acceptable types of salt include granular food grade, pool salt, water softener pellets, or solar salt flakes; these are usually available in 25 to 60 lb bags (11 to 27 kg) at local pool or building supply outlets. Pool salt or food grade granular salt will dissolve faster than pellets or flakes. Rock salt and Granular Salt with Iodine or Rust Preventatives should not be used, as these mixtures contain high levels of impurities and will cause staining. Granular salts containing anti-caking additives such as YPS (Yellow Prussiate of Soda) or sodium ferrocyanide are not recommended as they can cause a localized tint to the water or yellow staining of the pool / spa finish.

Amount of Salt Required

Test the water for current salt content first!

The ideal salt range is 3,500 – 4,500 ppm (mg/L). The minimum salt level is 2,500 ppm (mg/L). However, if so desired, the Pool Pilot® can operate with salt levels in excess of 35,000 ppm (mg/L). Salt levels above 6,000 ppm (mg/L) are not normally recommended as corrosion issues may result. Salt levels below 2,500 ppm (mg/L) will reduce the efficiency of the Pool Pilot®, and will result in low chlorine production. Extremely low salt levels below 1,900 ppm (mg/L) will activate the low salt safety cut off and will halt chlorine production until salt is replenished to proper levels.

Once the Pool Pilot® is programmed to the pool water volume, the controller will automatically indicate how much salt is required to attain salt level of 3,000 ppm (mg/L). For information on amount of salt to be added relative to the volume of water to be treated vs. existing salt level, refer to the "Reference" section in this manual. See "Salt Addition Chart" on page 40.

How to Add Salt to Pool

⚠ CAUTION - Failure to heed the following may result in equipment damage.

- For newly plastered pools, do not use a pool cleaner or vacuum head with wheels as wheels can leave track marks.
- Do not allow granular salt to pile up in one location without brushing as staining may occur.

The circulation pump should be run continuously until the salt has been fully dissolved – typically 24 hours. Add salt directly to pool or spa (if a spa-only installation) and over the main drain (if main drain is present). If there is no main drain, a vacuum head may be used to encourage salt circulation. Distributing the salt by brushing is also helpful; brush the salt toward the main drain (if one is present). Set pump operation to normal run time after salt has fully dissolved into water.

If the salt level becomes undesirably high, the only way to remove excess salt is to partially drain the pool / spa and refill with fresh water.

8.7 Programming at Installation

The Pool Pilot® requires the pool volume be programmed into the installer menu. The Pool Pilot® will then indicate how many pounds (kg) of salt to add should salt levels fall.

1. Enter the "Installer menu" and program "Set pool volume" for specific pool. See "Calculating Pool Volume" on page 25.
 - a. Press MENU/ENTER.
 - b. Press Δ or ∇ until "Installer menu" is displayed.
 - c. Press MENU/ENTER.
 - d. Press Δ or ∇ until "Set pool volume" is displayed, then press MENU/ENTER.
 - Factory setting is 000 gallons (000 liters).
 - The range is 000 to 1,000,000 gallons (000 to 4,000,000 liters).
 - e. Press Δ or ∇ until correct pool size (gallons or liters) is displayed; then press MENU/ENTER.
 - f. "Exit menu mode" will be displayed. Press MENU/ENTER.
2. Configure the following as needed. See "Review of Main Menu Programming" on page 19.
 - Alarm (On / Off)
 - Set reverse time
 - Set cell power (High / Low)
 - English / Metric (gallons/liters, lbs/kg, ppm / mg/L)
 - Temperature units (°F or °C)
3. Press Δ or ∇ to adjust chlorine output to 50%.

8.8 Electrical Connections

⚠ WARNING - Failure to heed the following may result in permanent injury or death.

- Ensure that all power is disconnected before wiring this unit.
- All electrical connections should be made by a licensed electrician or certified electrical contractor.

A high voltage AC input provides power to the control center. Low voltage cables provide power from the Pool Pilot® control center to the Tri-sensor and cell.

Damage due to incorrect wiring is not covered under the warranty.

8.8.a AC Input Voltage

⚠ WARNING - Failure to heed the following may result in permanent injury or death.

- The Pool Pilot® control center supply circuit must be protected by a ground-fault circuit- interrupter (GFCI). See "Electrical Connections" on page 28.

⚠ CAUTION - Failure to heed the following may result in equipment damage.

- The AC input cannot be provided by an ORP Controller.

The Pool Pilot® control center is typically provided input power either directly from a GFCI breaker or from a timer or controller. Determine which is best for your application. Although not required, ideally the circulation pump and Pool Pilot® are controlled by the same power.

8.8.b Bonding

The Pool Pilot® chlorinator must be connected to the pool / spa bonding system with an 8 AWG (6 AWG for Canada) wire. A bonding lug is provided at the bottom, exterior of the control center.

8.9 High Voltage Wiring

An electrical access panel is located on the lower right side of the control center. This panel allows access to the input power and optional ORP connections. Your Pool Pilot® control panel is capable of 220 – 240V@ 16 A, and 50/60 Hz input.

1. Remove the side access panel using a Phillips head screwdriver.
2. Route the incoming power wires through the strain relief.
3. Using at least 16 amperes of electrical service, connect your input wiring to the circuit panel as per the wiring diagram located on the access panel. Figure 20.
4. The circuit should be interfaced with the main circulation pump. This will ensure that the Pool Pilot® control center is not energized when the circulation pump is powered down.

LBP0217 Wiring Diagram

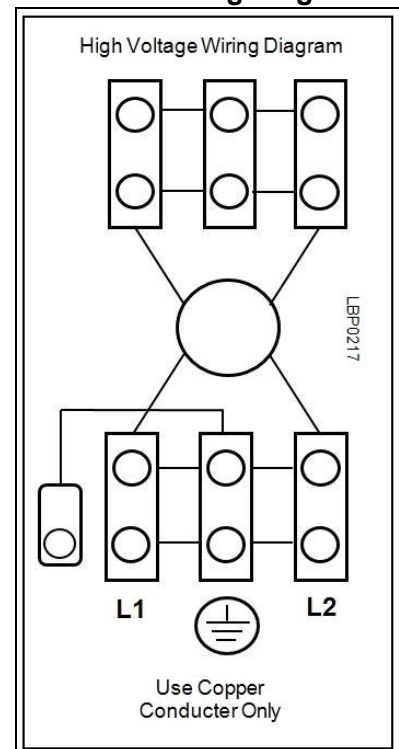

Figure 20

8.10 Low Voltage Wiring

8.10.a Tri-sensor Cord

The Tri-sensor cord is connected through the electrical access box.

1. Remove front access panel.
 - The access panel is secured by four (4) screws. Remove all four (4) of the screws
 - Lift off the panel to view the electrical access box
2. Remove the panel on the side of the cabinet to expose the electrical access box.
3. On the underside of the cabinet is another small access panel. Remove this panel.
4. Thread the Tri-sensor cord through the strain relief connector and attach the rectangular metal plate.
5. Align the Tri-sensor connector on the end of the cord to the connector on the side electrical panel.
6. When the Tri-sensor is attached, replace the small rectangular plate on the underside of the cabinet.

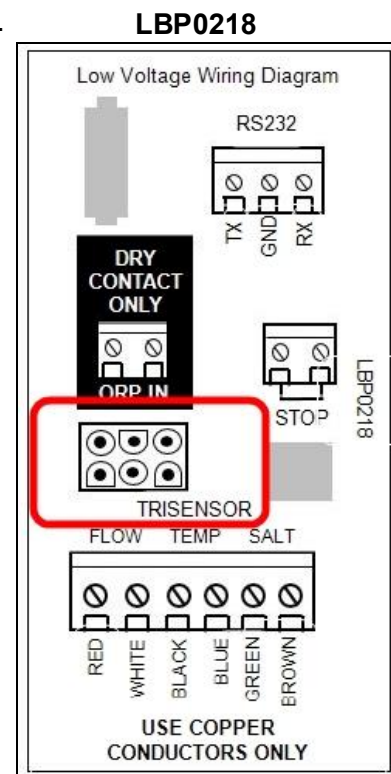

Figure 21

8.10.b Cell Cord

Depending on the model, there will be two (2) – six (6) cell cords provided with the complete system. The cell cords are **prewired** to the unit at the factory.

1. The cell cord should be seated firmly onto the cell terminals.
2. The other end of the cell cord attaches to the terminal block at the base of the control center. The black wire from the cell cord is matched to the center terminal (black wire) of the control center wiring.
3. The other two wires from the cell cord (red and white wires) can be connected to either of the outer terminals (red wires) of the terminal block.

Cell Cord Connection-Cell



Figure 22

Cell Cord Connection-Terminal Block

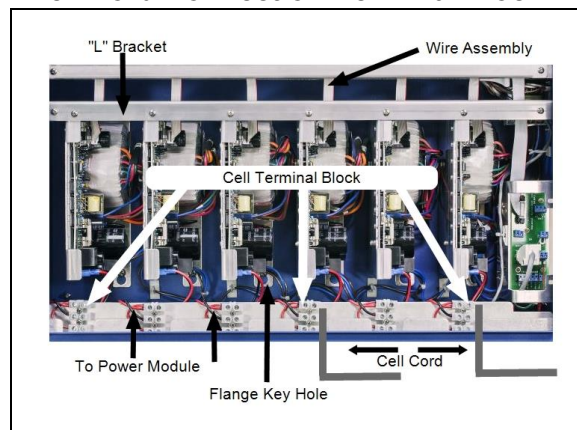

Figure 23

Note: To avoid mismatching or crossing cell connections, each cell and cell cord should be appropriately labeled with markings to identify them. AquaCal AutoPilot, Inc. recommends using a marking system of A-1, A-2, A-3, etc. for each cell and cell cord, then marking the power supply with PS-A and Tri-sensor with TS-A, etc. If additional units are used, they should be labeled B-1, B-2, PS-B, TS-B, etc. to guarantee that no wires or cords become crossed.

8.11 ORP Connection

ORP Connections

When an ORP chemical controller is interfaced to your Pool Pilot® Professional, and does not provide a Dry Contact ORP signal, the AutoPilot® ORP Relay Box (part # 110-ORP) is required. For ORP controllers with an ORP Dry Contact Signal, it can be wired directly to the units ORP IN terminal. The controller will control chlorine output. Once connected, as the controller measurement falls below the set point, the unit is activated to produce chlorine until the set point is satisfied. Check your local commercial guidelines for minimum and maximum ORP levels.

⚠ CAUTION - Failure to heed the following may result in equipment damage.

- The remote connections are compatible with either dry contact closure or solid-state relay. Do not energize these inputs! Damage to the control panel will occur and the warranty will be voided.

Connecting the Optional ORP Controller Relay

1. Turn off power to the unit by the power circuit breaker. Confirm there is no power going to the unit.
2. Remove the front cover plate and side access panel where the Dry Contact Only / ORP IN connection is located.
3. Cut off the connector and strip the wire casing 1/2" inch to expose the wires and connect the ORP controller wires to the terminal block marked ORP IN.
4. Adjust the purifier output level to 0%. The controller will takeover purifier output. The display will show as seen in Figure 26.

ORP and pH controller supplemental instructional sheets are provided when the optional controller is ordered.

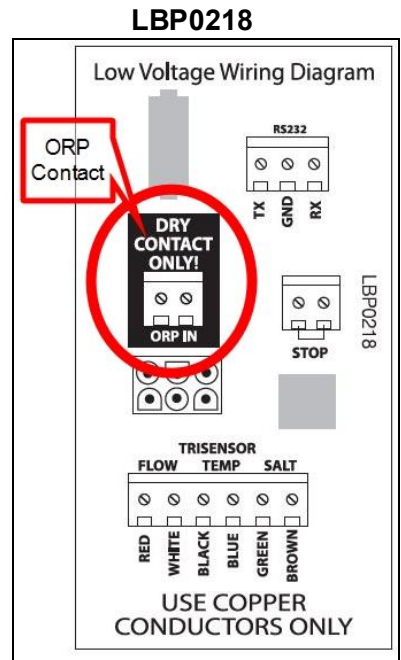

Figure 24

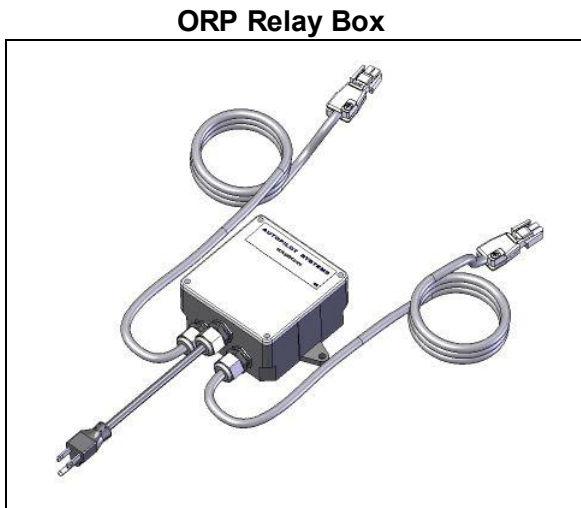

Figure 25

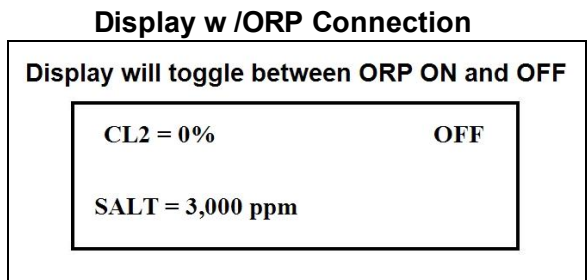

Figure 26

SECTION 9 - TROUBLESHOOTING

9.1 Troubleshooting

No Cell X

The unit has not detected a power module in that position.

Typical Solution

Confirm all connections are secure.

Problem

A ribbon connector may need to be replaced.

Typical Solution

Switch the ribbon connector with another power module to verify.

Problem

A power module may need to be replaced.

Typical Solution

Switch the ribbon connector with another power module to verify.

Cell X Not Found

The unit has detected that a power module is connected to that cell position but a signal is not being sent past the power module connection.

Typical Solution

Confirm all connections are secure.

Problem

The cell cord may need to be replaced.

Typical Solution

Switch cell cord with another cell to verify.

Problem

The cell may need to be replaced.

Typical Solution

Switch with another cell to verify.

Problem

A ribbon connector may need to be replaced.

Typical Solution

Switch the ribbon connector with another power module to verify.

Problem

A power module may need to be replaced.

Typical Solution

Switch the ribbon connector with another power module to verify.

!!!Warning!!! Cell X Low Amps

Problem

Cell may be depleted.

Typical Solution

Check for visual wear on the edges of the terminal blades, which may be an indication that the cell is depleted. Replace if depleted.

Problem

Low salt level.

Typical Solution

Verify salt level using a separate salinity tester (digital meter, salt strips, or reagent test kit).

Problem

The cell cord may be disconnected or damaged.

Typical Solution

Check the cell cord for tight connections on the cell and on the power supply. Tighten as needed.

Check the plug for burns. Replace as needed.

Problem

The cell may be heavily scaled.

Typical Solution

Remove and acid wash. See "Servicing the Cell" on page 13.

If all steps above have been performed and the error message is still shown, do the following:

1. Turn off power to the unit by the power switch on the control panel and wait three (3) minutes. If the unit was in Boost mode, deactivate the Boost cycle prior to powering off the unit.
2. Power the unit on and put in Boost mode, or increase the purifier output to 100%, and let run for three (3) minutes.
3. Press the TEST button and record the displayed diagnostics information. Be sure to make note of the cell amps and volts for each cell.
4. Deactivate Boost mode or return purifier output % to the original setting.

If test shows low volts and low amps, there may be a problem with the power module. Contact your local AutoPilot® service center or AquaCal AutoPilot Customer Support for further assistance.

Cell X - Zero Volts/Zero Amps

Problem

There may be a problem with the cell or cell cord.

Typical Solution

1. Check cell and cell cord connections. If cell is clean and all cords are seated properly and not damaged, proceed to the next step.
2. Turn off power to the unit by the power switch on the control panel and wait three (3) minutes. If the unit was in Boost mode, deactivate the Boost cycle prior to powering off the unit.
3. Power the unit on and put in Boost mode, or increase the purifier output to 100%, and let run for three (3) minutes.
4. Press the TEST button and record the displayed diagnostics information. Be sure to make note of the cell amps and volts for each cell.
5. Deactivate Boost mode or return purifier output to the original setting.

If high volts and low amps, check the cell and cell cord connections.

If test shows low volts and low amps, there may be a problem with the power module. Call your local AutoPilot® service center or AquaCal AutoPilot Customer Support for assistance.

CELL X light is not green

Problem

Possible low cell amperage.

Typical Solution

Replace the cell.

Problem

The cell cord may be disconnected from the cell.

Typical Solution

Verify the cell cord is firmly seated onto the cell terminals.

Problem

A fuse may be blown on the power module.

Typical Solution

Replace the fuse. See "Accessing the Power Module" on page 10.

Problem

LED light on the control board is damaged.

Typical Solution

Replace the 830 control board.

!!!Warning!!! No flow

Problem

Chlorine generation has stopped due to insufficient water flow.

Typical Solution

1. Turn on the circulation pump.
2. Turn the control valves to the correct position to allow water flow through the manifold.
3. Check and clean the skimmer basket.
4. Check and clean the pump basket.
5. Check and clean (or backwash) the main circulation filter.
6. Clean the AutoPilot® manifold screen of trash or debris. For instructions to clean the screen, test the flow switch, and clean the bypass valve, refer to the "Maintenance" section of this manual. See "Test Tri-sensor Flow Switch" on page 12.
7. Verify that the Tri-sensor cable is plugged in. When plugging in, use care to orient correctly before inserting into the unit.
8. Clean the cell if clogged with debris or calcium scale.
9. Check for air in the bypass manifold by loosening the top union on the cell to see if air or water comes out. If air comes out then there may be a vacuum side leak or the pump may be undersized. Check for a leak at the pump basket o-ring, a leaking valve or fitting.
10. If the pump is a variable speed pump, ensure there is sufficient flow to the manifold (or Tri-sensor if a convection cell system) to activate the flow switch? The low speed may not create enough flow for the manifold.

Warning: Low Salt / Add xxx lb

Problem

The salt level is below 2,500 ppm (mg/L) (which is low).

Typical Solution

This message will appear when salt is at 2,400 ppm (mg/L), or below. Add salt as indicated on the Pool Pilot® display to bring the salt level up to 3,000 ppm (mg/L).

If message still appears, confirm salt level with a tester. If salt level is sufficient and error message still appears, contact your local AutoPilot® Service Center. There may be a problem with the Tri-sensor or cell cord.

Warning! Bad temp sensor?

Problem

The Tri-sensor may be damaged. The unit will default to 75°F and continue to operate, but without the Automatic Temperature Compensation feature.

Typical Solution

Check the Tri-sensor cable; make sure it is not loose or disconnected.

If error message remains, check the water temperature using a thermometer. Record results and contact your local AutoPilot® service center for assistance.

Normal Display

Problem

There are no warning messages on the display, but the chlorine level is too low. Water quality looks dirty or cloudy.

Typical Solution

1. The chlorine setting has been fine, but a temporary boost of chlorine is needed to adjust for heavy rain or a temporary bather increase.
 - Press MENU/ENTER. Use the Δ or ∇ buttons to select Boost.
 - Use the Δ or ∇ buttons to choose the desired boost hours. Press MENU/ENTER to save value and exit.
 - The chlorine output will revert to the original setting after the selected Boost time has expired.
2. Check water balance. See "Water Balance and Chemistry Recommendations" on page 4. The Cyanuric acid level may be low and chlorine is being consumed quickly by UV rays from the sun.
3. The purifier output needs to be increased.
 - Use the Δ button to increase the purifier output setting. Press MENU/ENTER to save the change.
4. Consult your local pool service professional and test for high phosphate levels. Use a product such as Lo-Chlor[®] Lo-Phos[®] to reduce phosphates.
5. If the water temperature is 55 °F (10 °C) or colder, the Pool Pilot[®] has automatically turned the Purifier output down to 1% to avoid over-chlorination. Bacteria and algae activity is greatly reduced at these temperatures so this should not be a problem. Hand dose additional chlorine if necessary, or a short Boost cycle will override the temperature compensation feature.
6. Obtain an independent salt reading to check the Pool Pilot[®] reading. Add salt, if needed, and recalibrate the Pool Pilot[®] salt display.
7. Possible Pool Pilot[®] fault. Contact AquaCal AutoPilot Customer Support.

Problem

There are no warning messages on the display. The chlorine level is too low but the pool water looks fine.

Typical Solution

The test kit reagents or strips may be old or have been exposed to sunlight. Replace the kit or reagents and retest.

There may be too much chlorine in the pool. The chlorine is bleaching the test kit reagents.

- Dilute the water sample with distilled water and retest. Lower the chlorine output setting with the ∇ button if the chlorine level is too high.

Problem

Purifier % fluctuates from adjusted value.

Typical Solution

The AutoPilot[®] unit has a patented process for automatically increasing and reducing the chlorine output as the temperature of the water fluctuates. It is normal for the output % to increase as the water temperature increases, and to decrease as the water temperature decreases.

Blank display

Problem

The Pool Pilot® display is blank.

Typical Solution

1. If the display is in bright sunlight, then shade the display to read.
2. Verify local shut off switch and / or main circuit breaker for the Pool Pilot® is turned on.
3. If power is provided to unit by an external control device, verify power is provided to and from the device.
4. Fuse may be blown. See "Accessing the Power Module" on page 10.

No Error Displays

Problem

Salt level on display does not match pool store or salt test strip.

Typical Solution

1. The test may have been faulty or the salt strips may be old or damaged. Have salt level rechecked at local pool store.
2. If the discrepancy is more than 400 ppm (mg/L), calibrate salt. See "Calibrate Salt" on page 21.

DC plug and cell terminals burned

Typical Solution

The cell plug may not be securely seated onto the terminals, allowing moisture to seep into the plug. Ensure the cell cord is pressed completely onto the cell terminal. Check the terminals and clean with a dry cloth to remove possible dirt and corrosion.

If the cell terminals leak, contact the AquaCal AutoPilot Customer Support department.

Premature cell failure

Typical Solution

Abnormally high cell usage due to an insufficient stabilizer (Cyanuric acid) level. Check the stabilizer levels as recommended and adjust.

There may be debris in the cell. Check the cell monthly and clean debris as needed.

White flakes in the water

Typical Solution

This occurs when excessive calcium hardness is present. Visually inspect the cell for scale build up and clean the cell. See "Servicing the Cell" on page 13.

See "Water Balance and Chemistry Recommendations" on page 4.

Cell inspect due

This is an advisory message. The unit will generate chlorine normally while this message is displayed.

This is a reminder to remove and inspect the cell and filter screen to see if they need cleaning. No problem has been detected. This is simply a time elapsed maintenance message. Press and hold MENU/ENTER to clear this message.

SECTION 10 - REFERENCE

10.1 Basic Water Chemistry

The Pool Pilot® is designed to produce chlorine on a daily basis. To monitor the system's efficiency, the water chemistry ranges and a schedule of periodic checks should be followed.

⚠ CAUTION - Failure to heed the following may result in equipment damage.

- Excessively high chlorine levels can cause premature cell depletion and corrosion damage to pool fixtures and equipment.
- Always follow the instructions on the manufacturer's label whenever handling or using chemicals.

Chemical	Test Schedule	Effect of Low / High Levels	Corrective Actions
Free Chlorine	Check Local Codes	<u>Low free chlorine</u> : Not enough residual chlorine to safely sanitize pool water.	<u>Low free chlorine</u> : Check for combined chlorine level and shock as necessary. Increase chlorine output to maintain a 1-3 ppm (mg/L) residual. Check stabilizer level and add as necessary.
		<u>High free chlorine</u> : Corrosive to metallic fixtures in pool water. Can bleach swimwear and hair or cause premature chlorinator cell depletion.	<u>High free chlorine</u> : Decrease chlorine output. Let chlorine dissipate normally until 1-3 ppm (mg/L) is achieved. In extreme cases, pool water can be diluted with fresh water or a chlorine neutralizer added. (Diluting will reduce salt and CYA. Check and adjust as needed.)
pH	Check Local Codes	<u>Low pH</u> : (acidic) Equipment corrosion, eye/skin irritation, plaster etching, rapid chlorine consumption .	<u>Low pH</u> : Add sodium carbonate or soda ash.
		<u>High pH</u> : (basic) Scale formation, cloudy water, eye/skin irritation, poor chlorine effectiveness.	<u>High pH</u> : Add muriatic acid or sodium bisulfate.
Total Alkalinity	Monthly	<u>Low TA</u> : Eye irritation, pH "bounce", stained/etched plaster and metal corrosion.	<u>Low TA</u> : Add sodium bicarbonate.
		<u>High TA</u> : Constant acid demand, difficulty in maintaining pH, and contributes to scale formation or cloudy water conditions.	<u>High TA</u> : Add muriatic acid often or sodium bisulfate more frequently until the TA is within an acceptable range.
Calcium Hardness	Monthly	<u>Low CH</u> : Etching the plaster, equipment corrosion.	<u>Low CH</u> : Add calcium chloride flakes.
		<u>High CH</u> : Scale formation, cloudy water. Rapid cell scale buildup may exceed the system's self-cleaning capability and require manual cleaning.	<u>High CH</u> : Partially drain and refill pool with fresh water to dilute. (Diluting will reduce salt and CYA. Check and adjust as needed.)
Cyanuric Acid (CYA or Stabilizer)	Monthly	<u>Low CYA</u> : Chlorine depletion by UV rays (sun).	<u>Low CYA</u> : Add Cyanuric acid (1 lb.(0.45 kg) per 5,000 gallons (18,930 liters) increases CYA 25 ppm (mg/L).
		<u>High CYA</u> : Requires more chlorine to maintain proper sanitizer levels. Note: CYA not needed for indoor pools or bromine pools. Check local health codes for commercial pool guidelines.	<u>High CYA</u> : Partially drain and refill pool with fresh water to dilute. (Diluting will reduce salt. Check and adjust as needed.)
Saturation Index	Monthly	+ 0.3: Water is scale forming. Calcium carbonate is falling out of solution. This rapid buildup of scale may exceed the system's self-cleaning capability and require manual cleaning of the cell.	Balance the pool/spa water as close to an equilibrium of 0 as possible. See "Using the Saturation Index" on page 39.
		- 0.3: Water is corrosive and may take from other material it comes in contact with to form a natural balance. These materials can be metallic fixtures, swimwear, etc. Results can include cloudy water, eye/skin irritation, and poor chlorine effectiveness.	Balance the water as close to an equilibrium of 0 as possible. See "Using the Saturation Index" on page 39.
Salt	Monthly	<u>Low Salt</u> : Below 2,500 ppm (mg/L) can cause premature cell failure & reduce chlorine production	<u>Low Salt</u> : Add salt according to digital display on Pool Pilot® unit or salt chart.
		<u>High Salt</u> : Above 6,000 ppm (mg/L) can cause corrosion of metallic fixtures and will taste salty. Note: The Pool Pilot® can safely operate with salt levels up to 35,000 ppm (mg/L).	<u>High Salt</u> : If undesirably high, partially drain and refill the pool with fresh water. (Diluting will reduce CYA. Check and adjust as needed.)

10.1.a Chlorine

The desirable form of chlorine is called Free Chlorine. This form of chlorine is responsible for the actual sanitation activity in pools and spas. Free chlorine is highly reactive and, once added to pool / spa water, has a tendency to combine with organic matter in the pool / spa. It quickly attacks pathogens as well as other bather wastes. When chlorine combines, it chemically changes. The chlorine binds to organic matter and is referred to as Combined Chlorine. Combined chlorine is responsible for eye burn and skin irritations. Total Chlorine is the sum of free chlorine and combined chlorine. If a strong chlorine odor is noted, it is due to an excess of combined chlorine. It is important to test total chlorine as well as free chlorine. If there is a difference greater than 0.2 ppm (mg/L), a shock treatment should be initiated.

During peak chlorine demand (summer months, rainy season or heavy bather usage) it may be necessary to increase your chlorine output by increasing your purifier output setting. Conversely, during low chlorine demand, you can decrease your output to a lower setting. For extremely heavy chlorine demand or to boost your chlorine residual levels quickly, you can supplement with any type of chlorine or non-chlorine shock containing potassium monopersulfate.

During cold-water conditions (below 60 °F / 15.6 °C) chlorine demand is reduced significantly. For colder climate regions with sustained low temperatures, contact your local pool professional for proper pool winterizing instructions.

10.1.b pH

pH is a term used to refer to the degree of activity of an acid or base in the water. A low pH, acidic or corrosive water contributes to eye and skin irritation as well as damage to pool equipment. A high pH will result in scaling, cloudy water and ineffective sanitation. Improper pH also contributes to the strong smell, red eyes and dry itchy skin conditions usually associated with “too much chlorine”.

10.1.c Total Alkalinity

Total Alkalinity refers to the ability of the pool water to resist a change in pH. It helps manage or control the pH in the pool. The desired range is 80 to 100 ppm (mg/L). Low alkalinity is aggressive or corrosive and causes the pH readings to fluctuate (pH bounce). High alkalinity may cause cloudy water and scale forming conditions. Your chlorinator does not affect total alkalinity. Factors changing this measure are ancillary chemicals added to the pool and “out of balance” make-up water.

10.1.d Calcium Hardness

Calcium Hardness is a measure of calcium content in the water. If the calcium content is too high, calcium can drop out of solution; forming scale on equipment. A low level will cause the water to become corrosive as the water tries to naturally form equilibrium. This means the water will “leach” minerals from everything it meets. Damage to equipment and unpleasant swimming conditions result. Your chlorinator does not change calcium hardness. Factors changing this measure are ancillary chemicals added to the pool and “out of balance” make-up water.

10.1.e Cyanuric Acid

Cyanuric Acid acts as water “Stabilizer” or “Conditioner”. This chemical goes by either trade name and allows your chlorine residual to last longer by protecting it from the UV rays of the sun. With low cyanuric acid, chlorine can be used up just as quickly as it is generated. Check local commercial codes for maximum acceptable cyanuric acid levels in commercial projects. For indoor pools, it is not necessary to maintain a stabilizer level to protect the chlorine from the UV rays.

10.2 Using the Saturation Index

This index is used by pool professionals to ensure that your total water chemistry does not fall into a corrosive or scaling condition. Either condition can cause premature damage to the cell, any of your other equipment, as well as your cementitious finish.

The Saturation Index is composed of the following factors:

- pH as tested
- Plus the Temperature factor
- Plus the Calcium Hardness factor
- Plus the Alkalinity factor
- Minus the Total Dissolved Solids factor (in this case the bulk of the dissolved solids are salt)

This is expressed in the formula $SI = pH + TF + CF + AF - TDSF$ and uses the following charts:

TEMPERATURE		TF	CALCIUM HARDNESS		CF	TOTAL ALKALINITY		AF	SALT LEVEL		TDSF
60°F	15.6°F	0.4	150 ppm (mg/L)	1.8	075 ppm (mg/L)	1.9	0000 - 1000 ppm (mg/L)	12.1			
66°F	18.9°F	0.5	200 ppm (mg/L)	1.9	100 ppm (mg/L)	2.0	1001 - 2000 ppm (mg/L)	12.2			
76°F	24.4°F	0.6	250 ppm (mg/L)	2.0	125 ppm (mg/L)	2.1	2001 - 3000 ppm (mg/L)	12.3			
84°F	28.9°F	0.7	300 ppm (mg/L)	2.1	150 ppm (mg/L)	2.2	3001 - 4000 ppm (mg/L)	12.4			
94°F	34.4°F	0.8	400 ppm (mg/L)	2.2	200 ppm (mg/L)	2.3	4001 - 5000 ppm (mg/L)	12.5			
103°F	39.4°F	0.9	600 ppm (mg/L)	2.4	250 ppm (mg/L)	2.4	5001 - 6000 ppm (mg/L)	12.6			

Example:

7.8 = pH as measured

0.7 = Temperature is 84°F (TF)

2.4 = Calcium Hardness is 600 ppm (mg/L) (CF)

2.3 = Total Alkalinity is 200 ppm (mg/L) (AF)

12.4 = Salt is 3,500 ppm (mg/L) (TDSF)

0.8 = Saturation Index. This water is scale forming and needs to be balanced

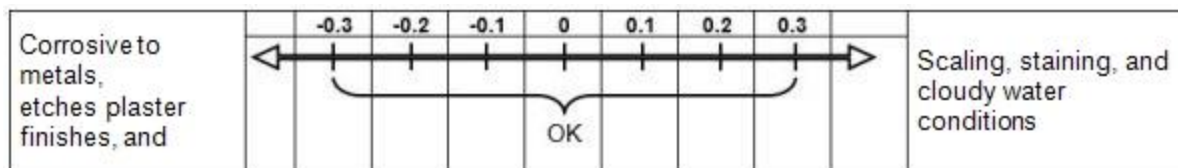

If adjustments need to be made to balance the water, the recommended sequence is as follows:

1. Test and adjust total alkalinity. This may reduce pH so wait at least 8 hours before proceeding.
2. Test again and adjust pH, then
3. Adjust calcium hardness.

10.3 Salt Addition Chart

The following salt charts are included for reference only; once programmed to the correct water volume, the controller will automatically indicate how much salt is required to achieve optimum water salinity.

The salt in the pool is constantly recycled during normal operation. Loss of salt during a swimming season should be minimal. Filter back washing, draining due to rain water overflow, splashing, bathing suit drag out, and leaks are typical ways salt is lost. Salt does not leave the pool when water evaporates.

1. Determine pool / spa volume in Gallons or Liters.
2. Find current salt level in the pool. Many pools will already have a significant salt residual, so always test water before adding salt. (This can be obtained from the control display or by testing water.)
3. Using the Salt Addition Chart below, find the current salt level in the left column.
4. Determine and locate the pool / spa volume in the top column.
5. Locate the intersection of the row and column to find the amount of salt needed to bring the pool to the ideal level.
6. For volumes other than what is shown, use combinations of various columns.

Example:

For an 11,000 gallon (42,000 Liter) pool with a salt level of 500 ppm (mg/L), the column value for 1,000 gallons (3,800 Liter) is added to the column value for 10,000 gallons (38,000 Liter), which gives a total of 230 pounds (104.3 kg) of salt needed to bring your pool salt level up to the ideal level of between 3,000 and 4,500 ppm (mg/L).

Current Salt Level ppm (g/L)	Pounds (kilograms) of Salt Needed to Attain 3,000 ppm (3.0 g/L)									
	Pool/Spa Volume in Gallons (Liters)									
	1,000 (3,800)	2,000 (7,600)	5,000 (19,000)	10,000 (37,900)	15,000 (56,800)	20,000 (75,700)	25,000 (94,700)	30,000 (113,600)	35,000 (132,500)	40,000 (151,400)
0	25	50	125	250	375	500	626	751	876	1001
(0)	11	23	57	113	170	227	284	340	397	454
250	23	46	115	229	344	459	573	688	803	917
(947)	10	21	52	104	156	208	260	312	364	416
500	21	42	104	209	313	417	521	626	730	834
(1892)	9	19	47	95	142	189	236	284	331	378
750	19	38	94	188	281	375	469	563	657	751
(2839)	9	17	43	85	128	170	213	255	298	340
1000	17	33	83	167	250	334	417	500	584	667
(3785)	8	15	38	76	113	151	189	227	265	303
1250	15	29	73	146	219	292	365	438	511	584
(4732)	7	13	33	66	99	132	166	199	232	265
1500	13	25	63	125	188	250	313	375	438	500
(5678)	6	11	28	57	85	113	142	170	199	227
1750	10	21	52	104	156	209	261	313	365	417
(6625)	5	9	24	47	71	95	118	142	166	189
2000	8	17	42	83	125	167	209	250	292	334
(7570)	4	8	19	38	57	76	95	113	132	151
2250	6	13	31	63	94	125	156	188	219	250
(8517)	3	6	14	28	43	57	71	85	99	113
2500	4	8	21	42	63	83	104	125	146	167
(9464)	2	4	9	19	28	38	47	57	66	76
2750	2	4	10	21	31	42	52	63	73	83
(10410)	1	2	5	9	14	19	24	28	33	38
3,000	Ideal									
3,500 (3.5)	OK for Pool Pilot® Operation – (This is typically the maximum salt level desired by most pool owners/operators since most people can taste salt levels above this. Greater than 6,000 ppm can cause corrosion to metallic objects. If lower salt level is desired, partially drain and refill with fresh water.)									

SECTION 11 - APPROVALS

11.1 Agency Approvals

Tested to conform to the following specifications:

SPECIFICATION	DESCRIPTION
UL1081	Safety Standard for Swimming Pool Pumps, Filters and Chlorinators.
CAN/CSA-C22.2#218.2:2015 Ed.2	Spas, Hot Tubs and Associated Equipment
NSF/ANSI 50	Equipment and Chemicals for Swimming Pools, Spas, Hot Tubs and Other Recreational Water Facilities

11.2 FCC Compliance

NOTE: This equipment has been tested and found to comply with the limits for a Class B digital device, pursuant to part 15 of the FCC Rules. These limits are designed to provide reasonable protection against harmful interference in a residential installation. This equipment generates, uses and can radiate radio frequency energy and, if not installed and used in accordance with the instructions, may cause harmful interference to radio communications. However, there is no guarantee that interference will not occur in a particular installation. If this equipment does cause harmful interference to radio or television reception, which can be determined by turning the equipment off and on, the user is encouraged to try to correct the interference by one or more of the following measures:

- Reorient or relocate the receiving antenna.
- Increase the separation between the equipment and receiver.
- Connect the equipment into an outlet on a circuit different from that to which the receiver is connected.
- Consult the dealer or an experienced radio / TV technician for help.



www.aquacal.com



www.autopilot.com

AquaCal AutoPilot, Inc.
2737 24th Street North
St. Petersburg, Florida 33713
(727) 823-5642