

# 12V Integrated LED Hardscape

Delivering rotation flexibility exactly where you need it



**KICHLER**

# Kichler's® New 12V Integrated LED Hardscapes

The next generation in hardscape lighting.

This new design offers pivot rotation, enhanced optical lens for uniform light and expanded versatile installation for more creative layout options. The 12V Integrated LED Hardscape is ideal for illuminating retaining walls and adding safety to outdoor areas such as outdoor kitchens and steps.

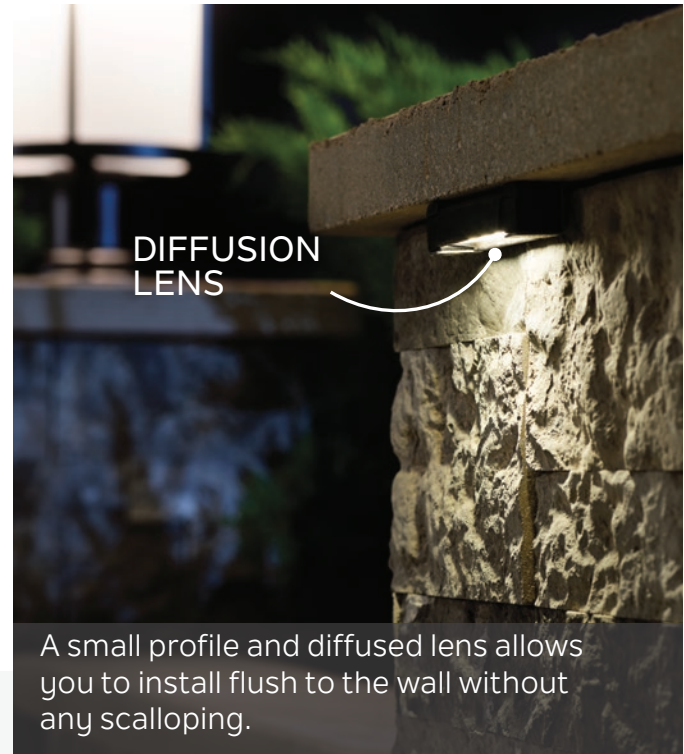

## FEATURES & BENEFITS

- The adjustable fixture can pivot 180° for direct to surface install and pivot 270° when installed with mounting bracket. Usable range is installation dependent.
- Offering a custom optical lens that diffuses light to deliver smooth, uniform output while eliminating hotspots and glare that may reflect off walls or installation surfaces.
- Can be installed either as a traditional downlight or as an uplight, on or off mounting bracket.
- Housing cavity and electronics are encapsulated to help keep all critical components protected against the elements.
- 4,000-volt system surge protection helps guard against system power surges and irregularities.
- Customizable mounting bracket with breakaway corner tabs that allow for easier installations in retrofit applications.
- Bracket is designed as an installation template with centering notch and screw pilot holes for installation guidance when mounting off bracket.



Available in 3.5", 6", 12" and 18" length options to fit most design applications.  
Shown: 16100BKT27 and 16102BKT27

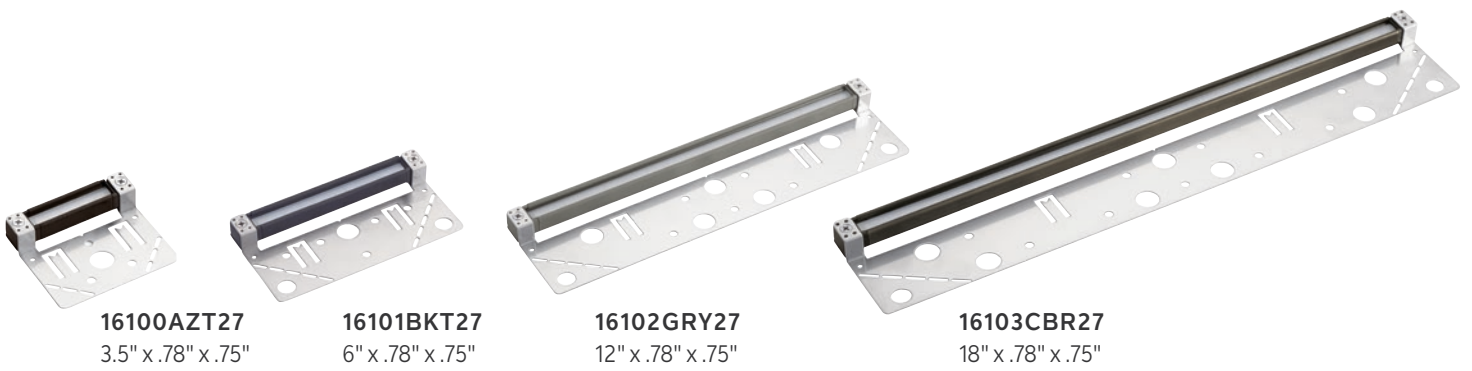

**16100AZT27**  
3.5" x .78" x .75"

**16101BKT27**  
6" x .78" x .75"

**16102GRY27**  
12" x .78" x .75"

**16103CBR27**  
18" x .78" x .75"

Backed by Kichler Lighting's 15-Year Limited Warranty for consumer purchasers and 10-Year Limited Warranty for commercial purchasers.



# Product Specifications & Ordering Guide

Ordering Guide (product number breakdown)	<b>1</b> Item Number for Fixture Size	<b>2</b> Product Finish:	<b>3</b> Color Temperature:
	<b>16100</b> = 3.5" Hardscape <b>16101</b> = 6" Hardscape <b>16102</b> = 12" Hardscape <b>16103</b> = 18" Hardscape	<b>AZT</b> = Textured Architectural Bronze <b>BKT</b> = Textured Black <b>CBR</b> = Centennial Brass <b>GRY</b> = Textured Gray <b>SD</b> = Textured Sand	<b>27</b> = 2700K, Warm White <b>30</b> = 3000K, Pure White
Example: 16101 CBR 30	<u>1</u> <u>6</u> <u>1</u> <u>0</u> <u>1</u>	<u>C</u> <u>B</u> <u>R</u>	<u>3</u> <u>0</u>

Fixture	16100	16101	16102	16103	Power (VA)	Wire Gauge / Length / (ft/m) Load Chart			
						10 AWG	12 AWG	14 AWG	16 AWG
Fixture Length	3.5"	6"	12"	18"	0-20 VA	1860'/567 m	1150'/351 m	730'/223 m	450'/137 m
Lumen Output	10	40	85	125	40 VA	930'/283 m	580'/177 m	370'/113 m	230'/70 m
Input Voltage	9-15	9-15	9-15	9-15	60 VA	620'/189 m	390'/119 m	240'/73 m	150'/46 m
Power (W) @ 12VAC	0.3	0.9	1.9	2.7	80 VA	470'/143 m	290'/88 m	180'/55 m	110'/34 m
Power (VA) @ 12VAC	0.6	1.5	2.9	3.8	100 VA	370'/113 m	230'/70 m	140'/43 m	90'/27 m
Efficacy (L/W)	43	45	45	46	>100 VA	Consult Technical Support			





## FOOT-CANDLES (108° BEAM ANGLE)

16100 - 3.5" Hardscape							16101 - 6" Hardscape						
Foot-candles	Mounting Height	Lateral distance from fixture					Foot-candles	Mounting Height	Lateral distance from fixture				
		0	1 ft.	2 ft.	3 ft.	4 ft.			0	1 ft.	2 ft.	3 ft.	4 ft.
6 in.	17.96	0.44	0.01	0.00	0.00	0.00	6 in.	72.60	0.88	0.00	0.00	0.00	
1 ft.	4.49	1.14	0.11	0.01	0.02	0.02	1 ft.	18.15	3.78	0.22	0.01	0.03	
2 ft.	1.12	0.76	0.28	0.09	0.03	0.03	2 ft.	4.54	2.88	0.94	0.23	0.05	
3 ft.	0.50	0.42	0.25	0.13	0.06	0.06	3 ft.	2.02	1.65	0.93	0.42	0.16	

16102 - 12" Hardscape							16103 - 18" Hardscape						
Foot-candles	Mounting Height	Lateral distance from fixture					Foot-candles	Mounting Height	Lateral distance from fixture				
		0	1 ft.	2 ft.	3 ft.	4 ft.			0	1 ft.	2 ft.	3 ft.	4 ft.
6 in.	143.2	2.68	0.02	0.00	0.00	0.00	6 in.	216.4	3.25	0.01	0.00	0.00	
1 ft.	35.81	8.31	0.67	0.06	0.11	0.11	1 ft.	54.10	12.28	0.81	0.05	0.13	
2 ft.	8.95	5.86	2.08	0.58	0.17	0.17	2 ft.	13.53	8.88	3.07	0.79	0.20	
3 ft.	3.98	3.29	1.93	0.92	0.39	0.39	3 ft.	6.01	4.99	2.90	1.36	0.56	

## AVAILABLE FINISHES

 <b>AZT</b> Textured Architectural Bronze	 <b>BKT</b> Textured Black	 <b>CBR</b> Centennial Brass
 <b>GRY</b> Textured Gray	 <b>SD</b> Textured Sand	

## GENERAL FIXTURE SPACING GUIDELINE

Item	16100 (3.5")	16101 (6")	16102 (12")	16103 (18")
<b>Mounting Height</b>	Recommended Spacing (center-to-center of fixtures)			
6"-18"	<b>3'-4'</b>	4'-5'	6'-8'	6'-8'
24"	3'-4'	<b>4'-5'</b>	6'-8'	6'-8'
36"	3'-4'	<b>4'-6'</b>	<b>6'-8'</b>	6'-8'
48"	3'-4'	4'-6'	<b>6'-8'</b>	<b>6'-8'</b>
60"	3'-4'	4'-6'	6'-8'	<b>6'-8'</b>

Highlighted values are optimal selections for mounting height application  
 Tip: Use centering notch on mounting bracket to aid in spacing layout during installation.