

# PS ULTRA / PRO-SPRAY<sup>®</sup>

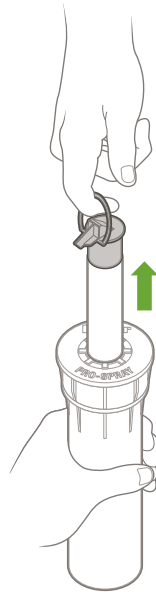

1

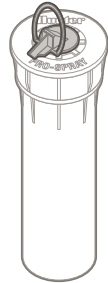

2

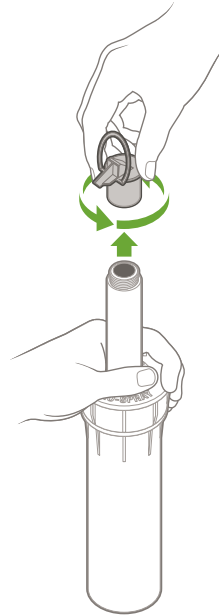

3

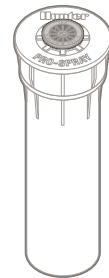
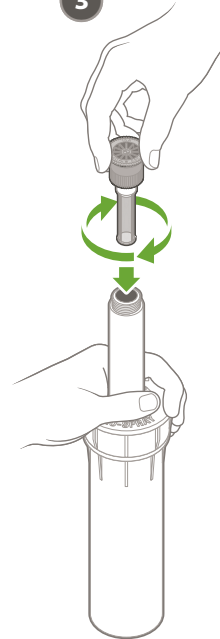

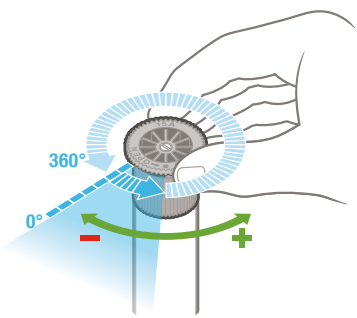
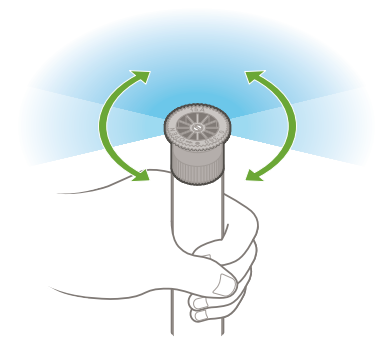
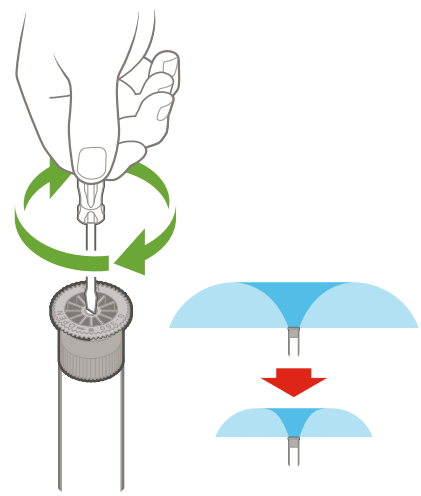
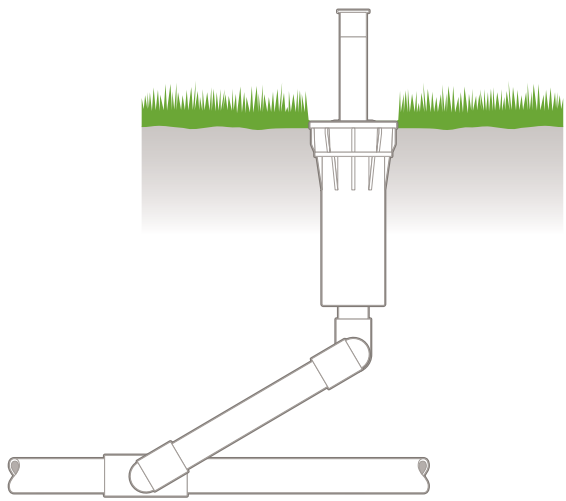



**10A**



1.0–3.0 Bar  
100–300 kPa  
20–40 PSI



0.7–9.5 l/m  
0.2–2.3 GPM



2.6–3.5 m  
(9'–11')



**12A**



1.0–3.0 Bar  
100–300 kPa  
20–40 PSI



0.7–13.4 l/m  
0.3–3.4 GPM



3.2 m–4.1 m  
(11'–13')



**15A**



1.0–3.0 Bar  
100–300 kPa  
20–40 PSI



1.3–18.0 l/m  
0.4–4.5 GPM



4.0 m–5.2 m  
(14'–17')



**17A**



1.0–3.0 Bar  
100–300 kPa  
20–40 PSI



1.7–21.7 l/m  
0.5–5.5 GPM



4.6 m–5.8 m  
(16'–19')