

NODE



EN

Battery-Operated Controller

Owner's manual and programming instructions

ES

Programador de pilas

Manual del usuario e instrucciones de programación

FR

Programmateur à piles

Manuel de l'utilisateur et consignes de programmation

IT

Programmatore a batteria

Manuale dell'utente e istruzioni per la programmazione

DE

Batteriebetriebenes Steuergerät

Bedienungs- und Programmieranleitung

PT

Controlador de Funcionamento a Pilhas

Manual do Proprietário e Instruções de Utilização

TR

Pilli Kontrol Ünitesi

Kurulum, Programlama ve Kullanım Kılavuzu

Hunter®

TABLE OF CONTENTS

EN

NODE FEATURES	2
NODE COMPONENTS	3
Control Buttons	
LCD Display	
CONNECTING THE BATTERY/BATTERIES	4
ATTACHING SOLENOIDS	5
To Wire DC Solenoids to the NODE	
To Mount the NODE to a Valve (Figure 1)	
MOUNTING THE NODE	6
CONNECTING A WEATHER SENSOR	6
Setting the Date and Time	
IDLE MODE	7
RUN MODE	7
PROGRAMMING	7
Setting Watering Start Times	
Setting the Run Times	
Setting Watering Days	
Selecting Odd/Even Days to Water	
Selecting Interval Days to Water	
Setting the Seasonal Adjustment	
Turning the System Off	
Manual Watering	
Sensor Operation	
ADVANCED PROGRAMMING FEATURES	12
Sensor Bypass	
Easy Retrieve Memory	
Setting Master Valve Operation (NODE-200, NODE-400, & NODE-600 Only)	
Programmable Off (Up to 99 Days)	

BATTERY-LIFE INDICATOR	14
RESETTING CONTROLLER	14
TROUBLESHOOTING GUIDE	15
SPECIFICATIONS	16
NOTES	17

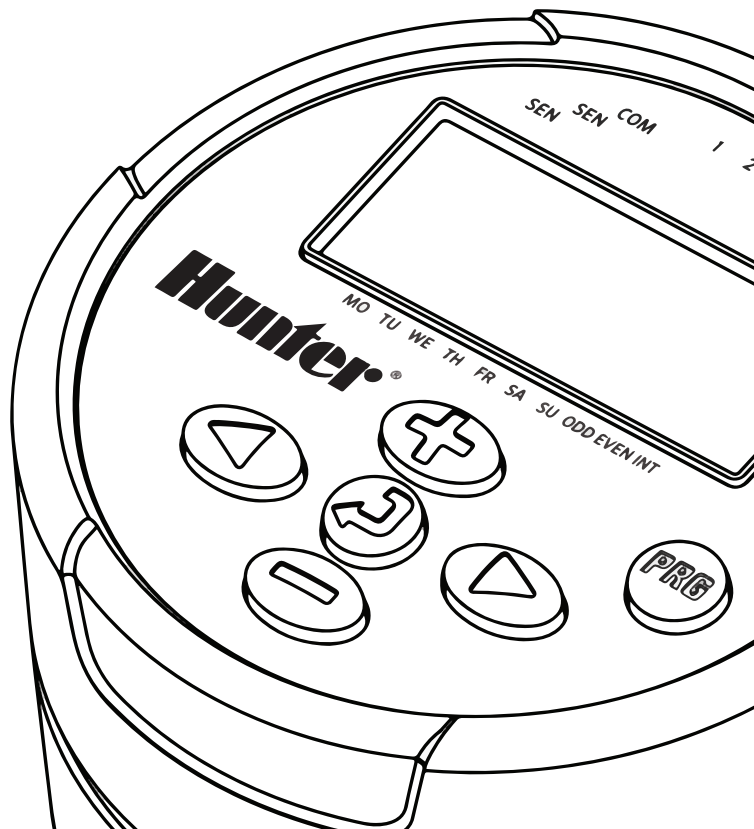

- Simple push-button programming
- Single-station model (NODE-100) with DC latching solenoid. Single-, two-, four-, or six-station models are also available (solenoids not included).
- Large Liquid Crystal Display (LCD) with easy-to-understand icons
- Operates using at least one standard nine-volt alkaline battery (use two for extended battery life)
- Three programs (A, B, or C) with up to four start times each
- Run times from one minute to six hours
- Manual watering capabilities
- Battery-life indicator
- Wired rain sensor compatible
- Non-volatile memory retains all program information
- Seasonal Adjustment from 10-150%
- Easy Retrieve™ memory allows saving/retrieval of preferred program data
- Manual bypass of rain sensor
- Total Run Time Calculator shows total program irrigation time per program

NODE COMPONENTS

This section provides an overview of some of the components of the NODE. Each item will be discussed in further detail later. However, this section can be helpful in getting acquainted with the different options available.

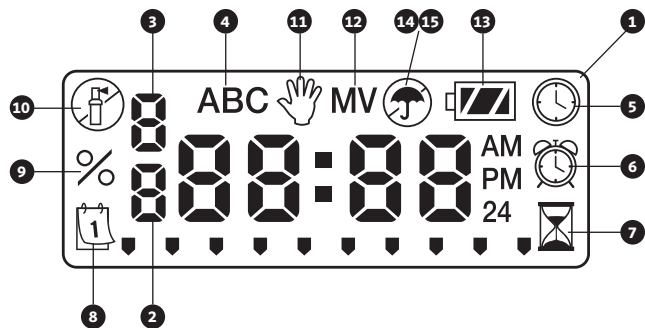

Control Buttons

1. **+** **Button** - Increases the selected flashing display
2. **-** **Button** - Decreases the selected flashing display
3. **↻** **Button** - Selects programming function
4. **▶** **Button** - Advances the selected flashing display back to the next item
5. **◀** **Button** - Navigates the selected flashing display back to the previous item
6. **PRG** **Button** - Selects the program (A, B, or C)

LCD Display

1. **Main Display** - Indicates all program information
2. **Station Number** - Indicates the station number being programmed
3. **Start Time Number** - Indicates the start timer number being programmed
4. **Program** - Indicates the program (A, B, or C)
5. **Current Time/Day** - Indicates when current day/time is being set
6. **Start Times** - Indicates when start times are being set
7. **Run Times** - Indicates when Run Times are being set. Allows user to set run times from one minute to six hours.
8. **Watering Days** - Allows the user to select individual days to water or a selected number of days between watering (interval)
9. **% Seasonal Adjustment** - Allows the seasonal adjustment to be programmed from 10-150% (default value is 100%)
10. **System Off** - Indicates that watering is suspended
11. **Manual On/Off** - Indicates when manual watering is programmed. Allows the user to activate the station manually.
12. **MV** - Indicates that station one is set to master valve operation (only available on two-, four-, or six-station models)
13. **Battery Status** - Indicates remaining battery life
14. **Umbrella** - Indicates the rain sensor is suspending irrigation
15. **Crossed Umbrella** - Indicates the rain sensor has been manually bypassed

CONNECTING THE BATTERY/BATTERIES

The NODE uses one or two standard nine-volt batteries (not included) to operate the valves and program the controller. The controller can operate using either a single nine-volt battery or using two nine-volt batteries. Under normal conditions, the expected life is one year for a single battery and two years when using two nine-volt batteries.



NOTE: The NODE has non-volatile memory. This allows the battery to be removed without losing program information.

To Install the Battery/Batteries

1. Unscrew the rear body of the NODE body to gain access to the battery compartment.
2. Insert the battery/batteries into the battery tray and connect to the controller using the battery connector.
3. Make sure that no water is inside the battery compartment.
4. Screw the NODE rear body back onto the front half.



NOTE: Verify that the seal marker on the rear half of the NODE lines up with the front half, ensuring that a proper seal is created.

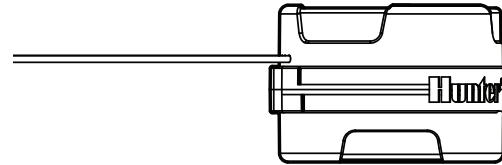
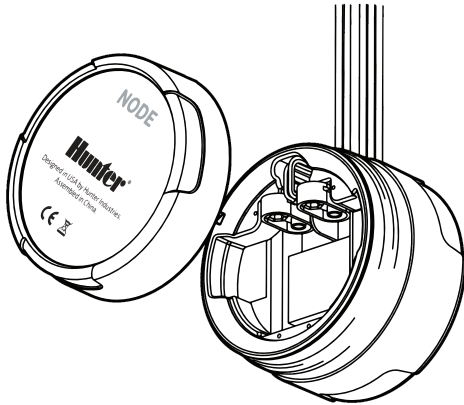

ATTACHING SOLENOIDS

The NODE-100 is provided with a solenoid attached to the controller. The NODE-100-LS does not include a solenoid. The NODE-200, NODE-400, and NODE-600 multi-station controllers will operate up to two, four, or six solenoids, respectively. Hunter DC-latching solenoids (P/N 458200) can easily be installed on all Hunter plastic valves.



NOTE: Use DC latching solenoids operating between 9-11 VDC. 24 VAC solenoids will not operate with the NODE.

To Wire DC Solenoids to the NODE

1. Attach the black leads from each solenoid to the single common wire (black lead) coming from the NODE. Secure all wire connections with waterproof connectors.
2. Attach one red wire from each solenoid to the corresponding station wire (red lead) from the NODE. The station numbers are identified on the face of the NODE. Secure all wire connections with waterproof connectors.



NOTE: The maximum wire distance between the solenoid and NODE is 100' (30 m) using 18 AWG (1 mm) minimum wire size.

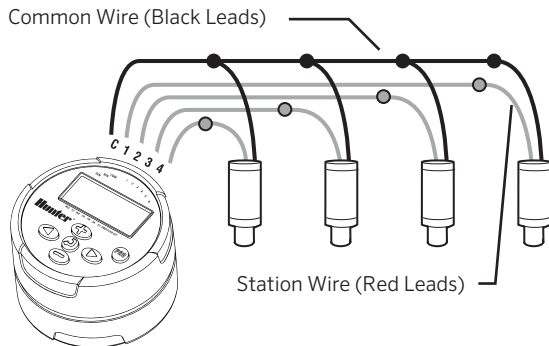

MOUNTING THE NODE

The NODE can easily be mounted on any Hunter plastic valve. A specially designed valve mounting clip makes installation a snap. A protective rubber cover is provided to prevent dirt from accumulating on the face of the NODE.

To Mount the NODE to a Valve (Figure 1)

1. Screw the Hunter DC latching solenoid (P/N 458200) into the valve bonnet.
2. Set the small open end of the NODE holder on top of the solenoid.
3. Set the NODE controller into the large open end of the NODE holder.

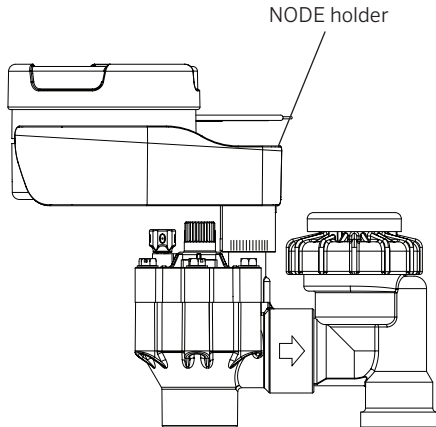

Figure 1

CONNECTING A WEATHER SENSOR EN

A Hunter Mini-Clik® or Wired Rain-Clik® rain sensor can be connected to the NODE. The purpose of this sensor is to stop watering when weather conditions dictate.



NOTE: When the Wired Rain Sensor is interrupting the watering, the display will show the System Off icon ☹️, "OFF" and 🌧️ on the display.

1. Cut the yellow wire loop attached to the NODE at approximately the middle of the loop.
2. Remove approximately ½" (13 mm) of insulation from each wire. Attach one yellow wire to each of the wires of the weather sensor. You can mount the rain sensor up to 100 ft (30 m) from the NODE controller (18 AWG/1 mm minimum wire size).
3. Secure wire connections with waterproof connectors.

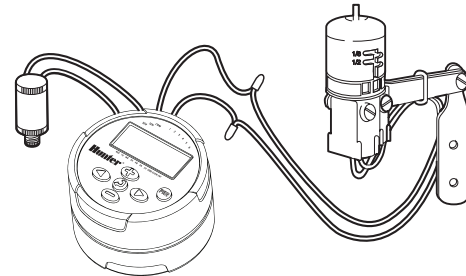

Hunter Model Mini-Clik®

IDLE MODE

Normally, the NODE display shows the time and day, day of the week, MV (if master valve option is activated), and the battery-life indicator. After a short period of inactivity, the display will shut off to retain battery power. Pressing any button will bring the NODE into idle mode.

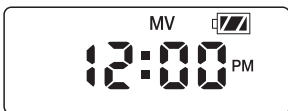





RUN MODE

When the controller is operating a program, the items shown on the display will include the station number, program letter, remaining run time, and the blinking Rotor icon.

















PROGRAMMING

EN

The NODE uses standard Hunter controller programming with three programs (A, B, or C) and four start times per program. On standard Hunter controllers a dial is used to scroll between the programming functions. However, on the NODE the  button is used to quickly and easily create the irrigation program. When programming, the flashing portion of the display can be changed by pressing the  or  buttons. To change something that is not flashing, press the  or  buttons until the desired item is flashing.









Setting the Date and Time

1. Push the  button until the  icon is displayed.
2. All four digits will be displayed representing the year. Use the  or  buttons to change the year. Press the  button to proceed to setting the month.
3. All four digits will be displayed with the two digits on the left representing the month flashing. Use the  or  buttons to change the month. Press the  button to proceed to setting the day.
4. Only the two digits on the right side will be displayed and flashing, representing the day. Press the  or  buttons to change the day. Press the  button to proceed with changing the hour. Press the  button to proceed to setting the time.
5. The AM/PM/24-hour time setting is shown flashing. Press the  or  button to change the time setting to AM, PM, or 24-hour time. Press the  button to proceed to setting the hour.







PROGRAMMING (CONTINUED)

EN

- All four numbers are shown with the two numbers on the left flashing, representing the hour. Use the  or  buttons to change the hour. Press the  button to proceed to setting the minutes.
- All four numbers are shown with the two numbers on the right flashing, representing the minutes. Use the  or  buttons to change the minutes. Pressing the  button will advance to the year setting at Step 2.
- Press the  button to proceed to the next programming function or allow controller to return to idle mode.









Setting Watering Start Times

- Press the  button until the  icon is displayed.
- The start time will be displayed flashing, along with the program letter (A, B, or C) and the start time number (1, 2, 3, or 4) in the upper left of the display. Up to 4 different start times can be set for each program.
- Use the  or  buttons to change the start time for the program that is displayed. Each press of the button will change the start time in one-minute increments.
- Press the  button to add an additional start time to the program displayed. The start time number is shown in the upper left corner of the display.
- Press the  button to add start times to a different program.
- Press the  button to proceed to the next programming function or allow controller to return to idle mode.



NOTE: After programming the run time for the last station press the  button to display the total run time for the program.









Setting the Run Times

- Press the  button until the  icon is displayed.
- The run time will be displayed flashing. Also shown is the program letter (A, B, or C) and the active station number on the lower left side of the display. Press the  or  buttons to change the station run time from one minute to six hours.
- Press the  button to advance to the next station.
- Press the  button to add a run time to another program.
- Press the  button to proceed to the next programming function or allow controller to return to idle mode.



PROGRAMMING (CONTINUED)



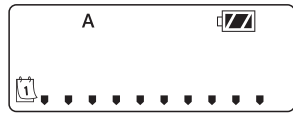
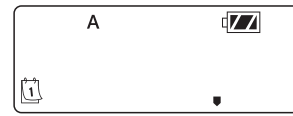

Setting Watering Days

1. Press the  button until the  icon is displayed.
2. The program letter (A, B, or C) will be displayed.
3. Arrows point at the specific days of the week on which watering will occur. Press the  or  buttons to scroll through the days.
4. Press the  button to activate that day for the program displayed, or the  button to cancel watering for that day. **The arrow will show on the watering days for the active program.**
5. Press the  button to set days to water for a different program, if desired.
6. Press the  button to proceed to the next programming function or allow controller to return to idle mode.









Selecting Odd/Even Days to Water

This feature uses numbered days of the month for watering instead of specific days of the week.



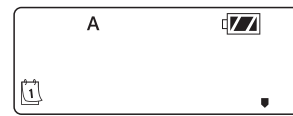

1. Press the  button until the  icon is displayed.
2. Press the  button until the cursor is above either ODD or EVEN on the display.
3. Press the  button to select, or the  button to cancel either ODD or EVEN days to water.
4. Once ODD or EVEN mode is activated, it will be the only cursor shown on the display.

Selecting Interval Days to Water

1. Press the  button until the  icon is displayed.
2. Press the  button until the cursor is above **INT** on the display.
3. Press the  button and a 1 will be flashing, indicating the number of days between watering.
4. Press the  or  buttons to select the number of days between watering days (1 to 31).



Setting the Seasonal Adjustment

1. Press the  button until the  is displayed.
2. Press the  or  button to increase or decrease the seasonal adjustment value from the default 100% (down to a minimum of 10% or a maximum of 150%).
3. The value programmed for seasonal adjustment will be applied to all irrigation programs and will immediately be reflected in

the run times displayed. For example, if 20-minute run times are programmed and then the seasonal adjustment is changed from 100% to 50%, the run times displayed will be 10 minutes.



Turning the System Off

To turn your controller off, press the button until the icon and **OFF** is displayed on screen. To return the controller to auto programming mode, press the button. The controller will immediately return to auto programming mode and will display the time and battery-life indicator.



Manual Watering

Manual Watering allows the user to test each station or a program for a specified run time. The weather sensor condition (if used) will be disregarded in this mode.

1. Make sure the controller is in idle mode. Press and hold the button until the icon is displayed.
2. The station number will be displayed in the lower left side of the display along with the run time.
3. Use the and buttons to select the desired station and the and buttons to set the manual watering time for the station shown.

4. To manually activate a program, press the button. The program letter (A, B, or C) will show on the screen. If a different program is needed, press the button until the desired program is displayed.
5. To stop the Manual Watering cycle, press the button until the time is reduced to zero.
6. Press the button to proceed to the next programming function or allow controller to return to idle mode.



NOTE:

- Pressing the or buttons when a station is running in Manual Watering mode will modify the irrigation time for that station.
- Pressing the button when a station is running in Manual Watering mode will stop irrigation on the current station and advance to the next station.
- Pressing the button when a station is running in Manual Watering mode will stop irrigation on the current station and revert to the previous station.

Sensor Operation

The NODE is compatible with Hunter Clik-type rain sensors, including Mini-Clik®, Freeze-Clik, and Wired Rain-Clik®, as well as many other interrupt-type devices/sensors that do not require power. Simply connect the sensor to the NODE controller by cutting the yellow wire loop and connecting to the sensor wires.



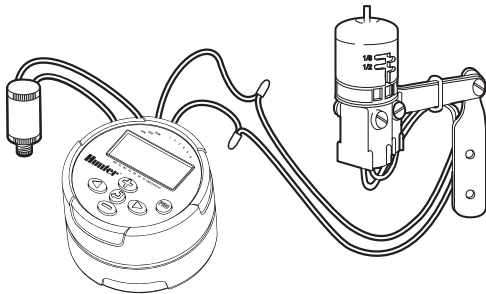

NOTE: NODE is not compatible with Hunter Wireless Rain-Clik® or other weather devices that require 24 VAC power.

When the sensor is activated, it will suspend irrigation and the ☂ icon will show on the display.





All advanced programming functions are initiated from the idle mode, which shows the time, day of the week, and battery-life indicator on the display. If something is flashing on the display then the controller is in one of the programming modes. After a short period of inactivity the controller will return to idle mode.



Sensor Bypass

1. From the idle mode, press and hold the  button until the  icon is displayed.
2. The display will show the umbrella icon flashing and **ON**.



3. Press the  button to bypass the sensor. The display will show  and **OFF** to indicate the weather sensor is bypassed. The  icon will show on the display during normal operation, indicating the controller is in bypass mode.





4. To reactivate the weather sensor, press and hold the  button until the  icon is displayed. Press the  button to return to normal sensor mode.

Easy Retrieve Memory



This function allows the user to save a preferred program to permanent memory in the controller, which can be restored at any time. This is a great way to override changes made, and revert back to the original programming schedule.

To save a program:

1. Make sure that the controller is programmed with the preferred programming schedule.
2. From idle mode, press and hold the  and  button for five seconds to save the current program.
3. The screen will show three dashed lines moving from left to right to indicate the current program is being saved to permanent memory. The display will flash **DONE** when the process is complete.



To retrieve a saved program:

1. From idle mode, press and hold the  and  button for five seconds.
2. The screen will show three dashed lines moving from right to left to indicate the preferred program is being retrieved from memory.



The controller now has the preferred program as the current program. The display will flash **DONE** when the process is complete.



NOTE: Be careful when using Easy Retrieve memory. Saving program data to memory using Easy Retrieve will take the current program information and override whatever is saved in permanent memory. When saving program data, make sure that the current program data is what you want saved.

Setting Master Valve Operation (NODE-200, NODE-400, & NODE-600 Only)

The multi-station NODE models (NODE-200, NODE-400, and NODE-600) can be programmed with the use of a normally closed master valve. When programming with the master valve you will be assigning Station 1 as the master valve, effectively losing the use of Station 1 for activation of an irrigation station.

1. From the idle mode, press the  button until the  icon is displayed.
2. Program A will be displayed along with the active station number on the lower left. Make sure the active station showing is "1." The run time will be shown.





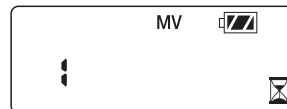

3. Press the  button once and the **MV** icon will display on the screen and the time will disappear. Station 1 is now acting as the master valve and will not be available in other programming screens.



4. When the master valve is activated, it will apply to all programs and the **MV** icon will stay displayed on the screen at all times.

Programmable Off (Up to 99 Days)

This feature permits the user to stop all programmed watering for the designated period from 1-99 days. At the end of the programmable off period, the controller will resume normal operation.

1. From idle mode, press the  button until the  icon is displayed. Wait two seconds until **OFF** is shown on the display. The controller is now in System Off mode.
2. Press the  button and a blinking "1" will be displayed, indicating the number of days the controller will stay off. Program the off days as desired, up to 99 days maximum.
3. The display will show the number of days remaining in the **OFF** period.
4. To interrupt the **OFF** period, press the  button to return to the idle mode screen, showing the time of day and day of the week.

BATTERY-LIFE INDICATOR

The remaining battery life can be estimated from the battery-life indicator shown on the display. The NODE can operate using either a single nine-volt battery or using two nine-volt batteries. Using two nine-volt batteries will yield approximately twice the battery life of a single nine-volt battery. The battery-life indicator chart below shows an estimate on the remaining battery life.

 Full: 100-60% remaining battery life

 Med: 60-25% remaining battery life







 Low: 25-0% remaining battery life

 Replace battery immediately!

RESETTING CONTROLLER

EN

Resetting the controller will erase the current program data and restart the controller. A reset does not, however, delete a program saved to permanent memory using the Easy Retrieve memory feature (see page 12) to save a preferred program.

1. From idle mode, press and hold the , , and  keys.
2. After two seconds the screen will go blank. Continue to hold the , , and  keys.
3. 12:00 will flash on the display. Release the keys.
4. The controller may show a countdown from 10 to 1 on the display, and then 12:00 AM will be shown flashing when the reset is complete. The controller can now be reprogrammed.

TROUBLESHOOTING GUIDE

EN

Problem	Causes	Solutions
There is no display.	Display is off. Battery is dead.	Press any button for one second. Replace the battery.
Display indicates watering but none is occurring.	No water pressure. Faulty solenoid. Incompatible solenoid.	Turn on main system supply. Replace solenoid. Must use Hunter DC latching solenoid (P/N 458200) or other compatible DC latching solenoid.
Automatic irrigation does not start at start time.	Controller in System Off mode. AM/PM/time of day not set correctly. AM/PM/start time not set correctly.	Verify that controller is programmed for automatic watering. Correct AM/PM/time of day. Correct AM/PM/start time.
Rain sensor does not suspend watering.	Rain sensor defective or miswired.	Verify proper operation of the rain sensor and wire connections (see page 11).
Controller waters more than one time.	The program has more than one start time assigned to it. Each program has up to four start times.	Eliminate program start times as needed.

SPECIFICATIONS

Dimensions: 3 ½"(89 mm) diameter, 2 ½"(64 mm) high

Sensor inputs: One

Power source: One nine-volt alkaline battery (use two for extended battery life). Activates DC latching solenoids operating 9-11VDC (Hunter PN 458200).

Operating temperature: 0°F to 140°F (-17°C to 60°C)

Approvals:

IP68
CE
FCC
C-Tick

ÍNDICE DE CONTENIDOS

SP

CARACTERÍSTICAS DE NODE	2
COMPONENTES DE NODE	3
Botones de control	
Pantalla LCD	
CONEXIÓN DE LA(S) PILA(S)	4
CONEXIÓN DE SOLENOIDES	5
Cableado de solenoides DC a NODE	
Montaje de NODE en una válvula (Figura 1)	
MONTAJE DE NODE	6
CONEXIÓN DE UN SENSOR METEOROLÓGICO	6
Configuración de la fecha y la hora	
MODO INACTIVO	7
MODO DE FUNCIONAMIENTO	7
PROGRAMACIÓN	7
Configuración de las horas de inicio de riego	
Configuración de los tiempos de riego	
Configuración de los días de riego	
Selección de días pares/impares de riego	
Selección de días de intervalo de riego	
Configuración del ajuste estacional	
Apagado del sistema	
Riego manual	
Funcionamiento del sensor	
CARACTERÍSTICAS DE PROGRAMACIÓN AVANZADAS	12
Bypass del sensor	
Memoria Easy Retrieve	
Configuración del funcionamiento de la válvula maestra (sólo para NODE-200, NODE-400 y NODE-600)	
Apagado programable (hasta 99 días)	
Quick Check de Hunter	

INDICADOR DE CARGA DE LA PILA	14
RESTABLECIMIENTO DEL PROGRAMADOR	14
GUÍA DE RESOLUCIÓN DE PROBLEMAS	15
ESPECIFICACIONES	16
NOTAS	17



- Programación sencilla con un botón.
- Modelo de una estación (NODE-100) con solenoides tipo “latch” de CC. También modelos de una, dos, cuatro o seis estaciones disponibles (no se incluyen los solenoides).
- Gran pantalla de cristal líquido (LCD) con iconos fáciles de entender.
- Opera con al menos una pila alcalina estándar de 9 voltios (use dos pilas para una mayor duración de las pilas).
- Tres programas (A, B o C) con hasta cuatro horas de inicio cada uno.
- Tiempos de riego de un minuto hasta seis horas.
- Capacidad de riego manual.
- Indicador de carga de la pila.
- Compatible con sensor de lluvia cableado.
- La memoria no volátil conserva toda la información de programas.
- Ajuste estacional entre 10% y 150%.
- La memoria Easy Retrieve™ permite guardar/recuperar los datos del programa preferido.
- Anulación manual del sensor de lluvia.
- La calculadora de tiempos de riego muestra el tiempo de riego total por programa.

Esta sección proporciona una vista general de algunos de los componentes del NODE. Cada elemento se describirá detalladamente en secciones posteriores. Sin embargo, esta sección puede resultar útil para familiarizarse con las distintas opciones disponibles.

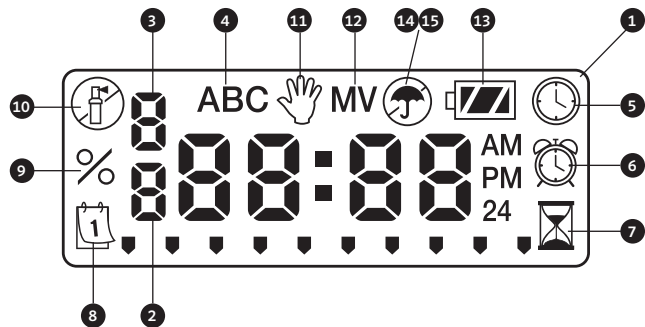

Botones de control

1. **Botón (+):** Aumenta el elemento seleccionado.
2. **Botón (-):** Disminuye el elemento seleccionado.
3. **Botón (☰):** Selecciona la función de programación.
4. **Botón (▶):** Desplaza el elemento seleccionado hasta el elemento siguiente.
5. **Botón (◀):** Desplaza el elemento seleccionado hasta el elemento anterior.
6. **Botón (PRG):** Selecciona el programa (A, B o C).

Pantalla LCD

1. **Pantalla principal:** indica toda la información del programa.
2. **Número de estación:** indica el número de estación que se está programando.
3. **Número de hora de inicio:** indica el número de hora de inicio que se está programando.
4. **Programa:** indica el programa (A, B o C).
5. **🕒 Día/hora actual:** aparece cuando se establece el día/hora actual.
6. **🕒 Horas de inicio:** aparece cuando se establecen las horas de inicio.
7. **🕒 Tiempos de riego:** aparece cuando se establecen los tiempos de riego. Permite al usuario configurar los tiempos de riego de un minuto hasta seis horas.
8. **📅 Días de riego:** permite al usuario seleccionar días individuales para regar o un número seleccionado de días entre riegos (intervalo).
9. **% de ajuste estacional:** permite la programación del ajuste estacional entre 10% y 150% (el valor por defecto es 100%).
10. **🛑 Sistema apagado:** indica que el riego se ha suspendido.
11. **👤 Encendido/apagado manual:** aparece cuando se programa el riego manual. Permite al usuario activar la estación manualmente.
12. **MV -** Indica que la estación uno está configurada a la operación de válvula maestra (solo disponible en los modelos de dos, cuatro o seis estaciones)
13. **🔋 Estado de la pila:** indica la duración restante de la pila.
14. **☔ Paraguas:** indica que el sensor de lluvia ha suspendido el riego.
15. **☔ Paraguas tachado:** indica que el sensor de lluvia se ha anulado manualmente.

CONEXIÓN DE LA(S) PILA(S)

El NODE utiliza una o dos pilas estándar de 9 voltios (no incluidas) para operar las válvulas y configurar el programador. El programador puede funcionar usando una sola pila de 9 voltios o dos pilas de 9 voltios. En condiciones normales, la esperanza de vida útil es de un año con una sola pila, y dos años cuando se utilizan dos pilas de 9 voltios.



NOTA: NODE tiene una memoria no volátil. Esto permite que la pila se retire sin perder la información del programa.

Instalación de las pilas

1. Desenrosque la tapa posterior del cuerpo de NODE para poder acceder al compartimento de las pilas.
2. Inserte las pilas y conéctelas al programador utilizando el conector.
3. Asegúrese de que no hay agua en el interior del compartimento de las pilas.
4. Vuelva a enroscar la tapa posterior en el cuerpo de NODE.



NOTA: Verifique que el marcador de sello en la mitad posterior del NODE se alinee con la mitad frontal para asegurar la creación de un sello adecuado.

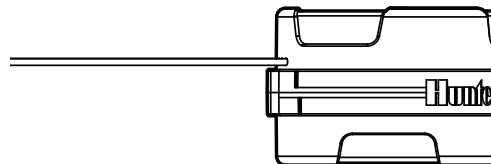
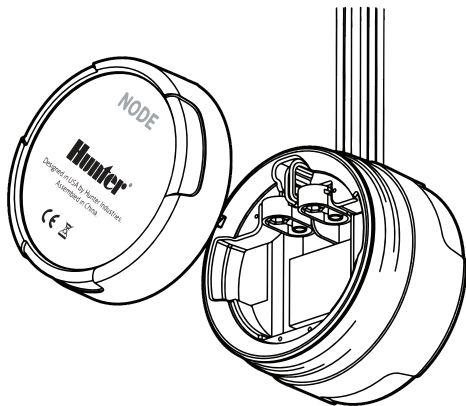

CONEXIÓN DE SOLENOIDES

El NODE-100 se proporciona con un solenoide conectado al programador. El NODE-100 se proporciona con un solenoide conectado al programador. Los programadores multiestación NODE-200, NODE-400 y NODE-600 operarán hasta dos, cuatro o seis solenoides, respectivamente. Los solenoides Hunter tipo "latch" de CC (P/N 458200) se pueden instalar fácilmente en todas las válvulas plásticas de Hunter.



NOTE: Use DC latching solenoids operating between 9-11 VDC. 24 VAC solenoids will not operate with the NODE.

Cableado de solenoides DC a NODE

1. Conecte los cables negros de cada solenoide al único cable común (cable negro) de NODE. Asegure todas las conexiones de cables con conectores estancos.
2. Conecte un cable rojo de cada solenoide al cable de estación correspondiente (cable rojo) de NODE. Los números de estación se identifican en la superficie de NODE. Asegure todas las conexiones de cables con conectores estancos.



NOTA: La distancia máxima del cable entre el solenoide y el NODE es 30 m (100') usando un cable con un calibre mínimo de 18 AWG (1 mm).

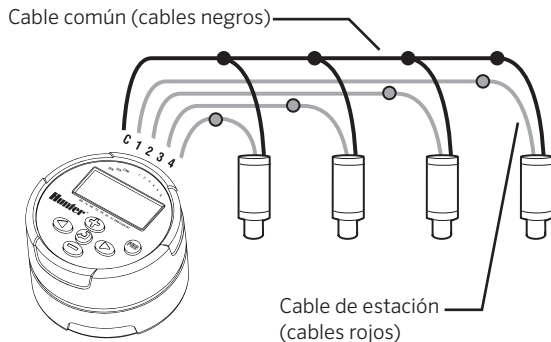

MONTAJE DE NODE

NODE se puede montar con facilidad en cualquier válvula de plástico de Hunter. Una pinza de montaje de válvula especialmente diseñada permite que la instalación sea sencilla. Se proporciona una cubierta protectora de goma para evitar que se acumule suciedad en la superficie de NODE.

Montaje de NODE en una válvula (Figura 1)

1. Atornille el solenoide Hunter tipo "latch" de CC (P/N 458200) en la tapa de la válvula.
2. Coloque el extremo pequeño abierto del soporte del NODE sobre el solenoide.
3. Coloque el programador NODE en el extremo grande abierto del solenoide.



Figura 1

CONEXIÓN DE UN SENSOR METEOROLÓGICO

Un sensor de lluvia Hunter Mini-Clik® o Rain-Clik® cableado se puede conectar al NODE. El propósito de este sensor es detener el riego si lo requieren las condiciones meteorológicas.

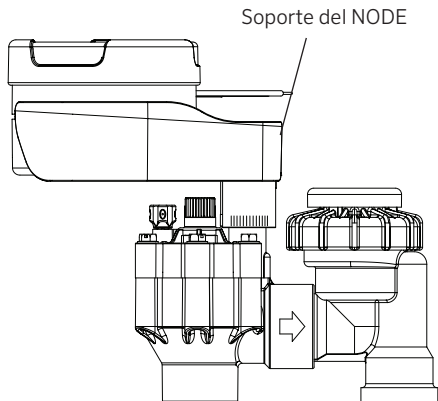

NOTA: Cuando el sensor de lluvia cableado está interrumpiendo el riego, la pantalla mostrará el ícono de sistema apagado (🚫), "OFF" y (☔).

1. Corte el bucle de cable amarillo acoplado a NODE aproximadamente en la parte media del bucle.
2. Pele aproximadamente 13 mm (1/2") de aislamiento de cada cable. Conecte un cable amarillo en cada uno de los cables del sensor meteorológico. Puede montar el sensor de lluvia hasta 30 m (100') del programador NODE (con un cable de calibre mínimo de 18 AWG/1 mm).
3. Asegure las conexiones de cables con conectores estancos.

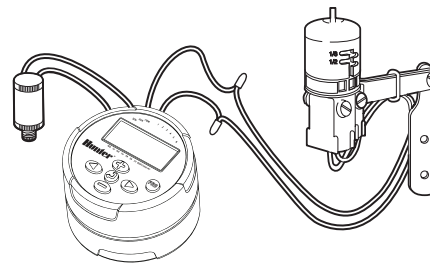

Modelo Mini-Clik® de Hunter

MODO INACTIVO

Normalmente, la pantalla del NODE muestra la hora y el día, el día de la semana, MV (si la opción de válvula maestra está activada) y el indicador de carga de la pila. Después de un breve período de inactividad, la pantalla se apagará para conservar carga de la pila. Presionar cualquier botón despertará al NODE del modo inactivo.

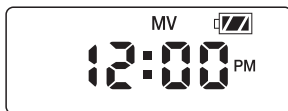

MODO DE FUNCIONAMIENTO

Cuando el programador está operando un programa, los elementos mostrados en la pantalla incluirán el número de estación, la letra del programa, el tiempo de riego restante y el ícono intermitente de la turbina.



PROGRAMACIÓN (CONTINUACIÓN) ES

The NODE uses standard Hunter controller programming with three programs (A, B, or C) and four start times per program. En los programadores Hunter estándar, se usa un dial para desplazarse por las funciones de programación; sin embargo, en el NODE se usa el botón para crear el programa de riego rápida y fácilmente. Durante la programación, la parte parpadeante de la pantalla se puede modificar pulsando los botones o . Para cambiar algo que no parpadee, pulse los botones o hasta que parpadee el elemento deseado.



Configuración de la fecha y la hora

1. Pulse el botón hasta que se muestre el ícono .
2. Se mostrarán los cuatro dígitos que representan el año. Utilice los botones o para cambiar el año. Pulse el botón para continuar con la configuración del mes.
3. Los cuatro dígitos se mostrarán con dos dígitos intermitentes a la izquierda representando el mes. Utilice los botones o para cambiar el mes. Pulse el botón para continuar con la configuración del día.
4. Solo los dos dígitos de la derecha, que representan el día, se mostrarán y parpadearán. Presione los botones o para cambiar el día. Pulse el botón para continuar con la configuración de la hora.
5. La configuración de hora AM/PM/24 horas también se muestra intermitente. Pulse el botón o para cambiar el ajuste de hora a formato AM, PM o 24 horas. Pulse el botón para continuar con la configuración de la hora.

- Los cuatro números se muestran con los dos números parpadeantes a la izquierda, que representan la hora. Utilice los botones o para cambiar la hora. Pulse el botón para continuar con la configuración de los minutos.
- Los cuatro números se muestran con los dos números parpadeantes a la derecha, que representan los minutos. Utilice los botones o para cambiar los minutos. Al presionar el botón avanzará a la configuración del año en el Paso 2.
- Pulse el botón para continuar con la siguiente función de programación o para permitir que el programador regrese al modo inactivo.



Configuración de las horas de inicio de riego

- Pulse el botón hasta que se muestre el icono .
- La hora de inicio se mostrará parpadeando, junto con la letra del programa (A, B o C) y el número de hora de inicio (1, 2, 3 o 4) en la parte superior izquierda de la pantalla. Se pueden configurar hasta 4 horas de inicio distintas para cada programa.
- Utilice los botones o para cambiar la hora de inicio para el programa en pantalla. Cada vez que el botón se presione cambiará la hora de inicio en incrementos de un minuto.
- Pulse el botón para añadir una hora de inicio adicional al programa mostrado. El número de hora de inicio se muestra en la esquina superior izquierda de la pantalla.
- Pulse el botón para añadir horas de inicio a un programa distinto.

- Pulse el botón para continuar con la siguiente función de programación o para permitir que el programador regrese al modo inactivo.











NOTA: Una vez programado el tiempo de riego para la última estación, pulse el botón para ver el tiempo de riego total para el programa.

Configuración de los tiempos de riego

- Pulse el botón hasta que se muestre el icono .
- El tiempo de riego se mostrará parpadeando. También se muestra la letra del programa (A, B o C) y el número de la estación activa en el lado izquierdo inferior de la pantalla. Presione los botones o para cambiar el tiempo de operación de la estación de un minuto a seis horas.
- Pulse el botón para desplazarse a la siguiente estación.
- Pulse el botón para añadir un tiempo de riego a otro programa.
- Pulse el botón para continuar con la siguiente función de programación o para permitir que el programador regrese al modo inactivo.





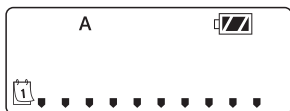

Configuración de los días de riego

1. Pulse el botón  hasta que se muestre el icono .
2. Se mostrará la letra del programa (A, B o C).
3. Las flechas señalan los días específicos de la semana en que el riego se activará. Pulse los botones  o  para desplazarse por los días.
4. Pulse el botón  para activar ese día para el programa mostrado, o bien el botón  para cancelar el riego para ese día. **La flecha aparecerá en los días de riego para el programa activo.**
5. Pulse el botón  para asignar días de riego para otro programa, en caso deseado.
6. Pulse el botón  para continuar con la siguiente función de programación o para permitir que el programador regrese al modo inactivo.







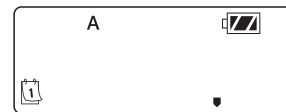

Selección de días pares/impares de riego

Esta característica utiliza días numerados del mes para el riego, en lugar de días específicos de la semana.

1. Pulse el botón  hasta que se muestre el icono .
2. Pulse el botón  hasta que el cursor esté sobre ODD (impar) o EVEN (par) en la pantalla.
3. Pulse el botón  para realizar la selección o el botón  para cancelar los días ODD (impar) o EVEN (par) de riego.
4. Una vez activado el modo ODD (impar) o EVEN (par), será el único cursor que aparezca en la pantalla.



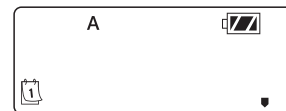

Selección de días de intervalo de riego

1. Pulse el botón  hasta que se muestre el icono .
2. Pulse el botón  hasta que el cursor esté sobre INT (intervalo) en la pantalla.
3. Pulse el botón  y la cifra 1 parpadeará indicando el número de días entre riegos.
4. Presione los botones  o  para seleccionar el número de días entre los días de riego (de 1 a 31).





Configuración del ajuste estacional

1. Pulse el botón  hasta que se muestre $\%^{INT}$.
2. Pulse el botón  o  para aumentar o reducir el valor de ajuste estacional a partir del valor 100% por defecto (entre un mínimo de 10% y un máximo de 150%).

- El valor programado del ajuste estacional se aplicará a todos los programas de riego y se reflejará inmediatamente en los tiempos de riego mostrados. Por ejemplo, si se programan tiempos de riego de 20 minutos, y luego se cambia el ajuste estacional de 100% a 50%, los tiempos de riego indicados serán de 10 minutos.





Apagado del sistema









Para apagar el programador, pulse el botón  hasta que el icono  y **OFF** (apagado) se muestren en pantalla. Para devolver el programador al modo de programación automática, pulse el botón . El programador inmediatamente volverá al modo de programación automática y mostrará la hora y el indicador de carga de la pila.



Riego manual





El riego manual permite al usuario probar cada estación o un programa para un tiempo de riego especificado. El estado del sensor meteorológico (si se utiliza) se descartará en este modo.

- Asegúrese de que el programador está en modo inactivo. Mantenga pulsado el botón  hasta que se muestre el icono .
- El número de estación aparecerá en el lado inferior izquierdo de la pantalla junto con el tiempo de riego.

- Utilice los botones  y  para seleccionar la estación deseada y los botones  y  para asignar el tiempo de riego manual para la estación mostrada.
- Para activar manualmente un programa, pulse el botón . La letra del programa (A, B o C) se mostrará en la pantalla. Si se necesita un programa distinto, pulse el botón  hasta que se muestre el programa deseado.
- Para detener el ciclo de riego manual, pulse el botón  hasta que el tiempo se reduzca a cero.
- Pulse el botón  para continuar con la siguiente función de programación o para permitir que el programador regrese al modo inactivo.



NOTA:

- Al presionar los botones  o  cuando una estación está en funcionamiento en el modo de riego manual, se modificará el tiempo de riego para esa estación.**
- Al pulsar el botón  cuando una estación está funcionando en riego manual, se detendrá el riego de la estación actual y se pasará a la estación siguiente.**
- Al pulsar el botón  cuando una estación está funcionando en riego manual, se detendrá el riego de la estación actual y se regresará a la estación anterior.**

Funcionamiento del sensor

El NODE es compatible con los sensores de lluvia Hunter tipo Klik, incluyendo los Mini-Klik®, Freeze-Klik, y Rain-Klik® cableado, así como con muchos otros dispositivos/sensores tipo interruptor que no requieren corriente. Basta con conectar el sensor al programador NODE cortando el bucle de cable amarillo y conectándolo a los cables del sensor.



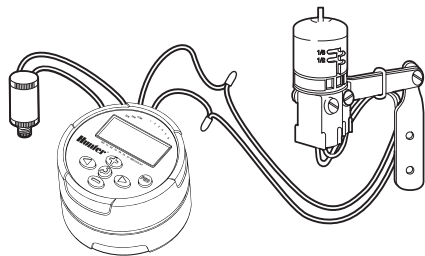

NOTA: NODE no es compatible con Wireless Rain-Klik® de Hunter ni con otros dispositivos meteorológicos que necesiten alimentación de 24 V CA.

Una vez activado el sensor, suspenderá el riego y el icono ☂ aparecerá en la pantalla.





Todas las funciones de programación avanzada se inician desde el modo inactivo, que muestra la hora, el día de la semana y el indicador de carga de la pila en la pantalla. Si en la pantalla algún elemento parpadea, significa que el programador está en uno de los modos de programación. Después de un corto período de inactividad, el programador regresa al modo inactivo.



Bypass del sensor

1. En el modo inactivo, mantenga presionado el botón  hasta que el icono  se muestre en la pantalla..
2. En la pantalla aparecerá el icono de paraguas parpadeando y **ON** (encendido).



3. Pulse el botón  para anular el sensor. La pantalla mostrará  y **OFF** para indicar que el sensor meteorológico está actualmente anulado. El icono  aparecerá en la pantalla durante el funcionamiento normal, lo que indica que el programador está en modo de bypass.





4. Para reactivar el sensor meteorológico, mantenga pulsado el botón  hasta que se muestre el icono . Pulse el botón  para regresar al modo normal de sensor.

Memoria Easy Retrieve



Esta función permite al usuario guardar un programa preferido a la memoria permanente en el programador, el cual se puede restaurar en cualquier momento. Se trata de una manera muy útil de anular los cambios realizados y regresar a la programación original.

Para guardar un programa:

1. Asegúrese de que el programador está programado con la programación preferida.
2. En el modo inactivo, mantenga presionados los botones  y  durante cinco segundos para guardar el programa actual.
3. La pantalla mostrará tres líneas punteadas que avanzan de izquierda a derecha para indicar que el programa actual se está guardando a la memoria permanente. En la pantalla parpadeará **DONE** (terminado) cuando finalice el proceso.



Para recuperar un programa guardado:

1. En el modo inactivo, mantenga presionados los botones  y  durante cinco segundos.
2. La pantalla mostrará tres líneas punteadas que avanzan de derecha a izquierda para indicar que el programa actual se está recuperando de la memoria permanente.



Al terminar el programador tendrá el programa preferido como programa actual. En la pantalla parpadeará **DONE** (terminado) cuando finalice el proceso.



NOTA: Preste atención al utilizar la memoria Easy Retrieve. Al guardar datos de programa en la memoria utilizando Easy Retrieve se utilizará la información del programa actual y se anulará todo lo guardado en la memoria permanente. Al guardar datos de programa, asegúrese de que la información del programa actual es la que desea guardar.

Configuración del funcionamiento de la válvula maestra (sólo para NODE-200, NODE-400 y NODE-600)

Los modelos NODE multiestación (NODE-200, NODE-400, y NODE-600) se pueden programar por medio de una válvula maestra normalmente cerrada. Al realizar la programación de la válvula maestra se asignará la estación 1 como válvula maestra, lo que provocará que se pierda de forma efectiva el uso de la estación 1 para la activación de una estación de riego.

1. En el modo inactivo, presione el botón  hasta que el ícono  se muestre en la pantalla.
2. El programa A se mostrará junto con el número de la estación activa en la parte izquierda inferior. Asegúrese que la estación activa indicada sea "1".
Se mostrará el tiempo de riego.





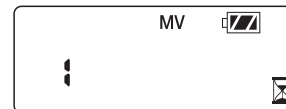

3. Pulse el botón  una vez para que el ícono **MV** aparezca en la pantalla y el tiempo desaparezca. A partir de ahora la estación 1 actúa como la válvula maestra y no estará disponible en otras pantallas de programación.



4. Cuando la válvula maestra se activa, lo hará en todos los programas y el ícono **MV** se mantendrá en pantalla en todo momento.

Apagado programable (hasta 99 días)

Esta característica permite al usuario detener todos los riegos programados durante un período designado de entre 1 y 99 días. Al final del período de apagado programable, el programador reanudará el funcionamiento normal.

1. En el modo inactivo, presione el botón  hasta que el ícono  se muestre en la pantalla. Espere dos segundos hasta que **OFF** (apagado) se muestre en la pantalla. El programador pasa el modo de sistema apagado.
2. Presione el botón  y se mostrará un "1" intermitente, lo que indica el número de días que el programador permanecerá apagado. Programe los días de apagado según sus necesidades, con un máximo de 99 días.
3. En la pantalla se mostrará el número de días restantes del periodo OFF (apagado).
4. Para interrumpir el período de apagado, presione el botón  para regresar a la pantalla de modo inactivo, que muestra la hora del día y el día de la semana.

INDICADOR DE CARGA DE LA PILA

La carga restante de la pila se puede calcular con el indicador de carga de la pila que se muestra en la pantalla. El NODE puede funcionar usando una sola pila de 9 voltios o dos pilas de 9 voltios. El uso de dos pilas de 9 voltios rendirá aproximadamente el doble de tiempo que una sola pila de 9 voltios. La tabla del indicador de carga de la pila muestra un estimado de la carga restante de la pila.

 Completa: 100-60% de duración restante de la pila







 Media: 60-25% de duración restante de la pila

 Baja: 25-0% de duración restante de la pila

 ¡Sustituya la pila inmediatamente!

RESTABLECIMIENTO DEL PROGRAMADOR

Al restablecer el programador se borrarán los datos del programa actual y se reiniciará el programador. Sin embargo, un restablecimiento no elimina un programa guardado en la memoria permanente utilizando la característica de memoria Easy Retrieve (consulte la página 12) para guardar un programa preferido.

1. En el modo inactivo, mantenga presionadas las teclas ,  y .
2. Transcurridos dos segundos, la pantalla se quedará en blanco. Continúe pulsando las teclas ,  y .
3. 12:00 parpadeará en la pantalla. Suelte las teclas.
4. Es posible que el programador muestre una cuenta atrás de 10 a 1 en la pantalla y, a continuación, se mostrará 12:00 AM parpadeando cuando finalice el restablecimiento. Ahora el programador se puede reprogramar.

Problema	Causas	Soluciones
No aparece nada en pantalla.	La pantalla está apagada. Se ha agotado la pila.	Presione cualquier botón durante un segundo.
La pantalla indica riego pero no sucede nada.	El agua no tiene presión. Solenoides defectuosos. Solenoides incompatibles.	Active el suministro principal del sistema. Sustituya el solenoide. Debe utilizar un solenoide de impulsos de Hunter (N/P 458200) u otro solenoide de impulsos compatible.
El riego automático no se activa a la hora de inicio.	Programador en modo de sistema apagado. El modo AM/PM de la hora del día no se ha asignado correctamente. El modo AM/PM de la hora de inicio no se ha asignado correctamente.	Compruebe que el programador se ha programado para el riego automático. Corrija el modo AM/PM de la hora del día. Corrija el modo AM/PM de la hora de inicio.
El sensor de lluvia no suspende el riego.	Sensor de lluvia defectuoso o cables mal conectados.	Compruebe el funcionamiento correcto del sensor de lluvia y la conexión de los cables (consulte la página 10).
El programador riega más de una vez.	El programa tiene más de una hora de inicio asignada a él. Cada programa tiene hasta cuatro horas de inicio.	Elimine horas de inicio del programa según sea necesario.

Dimensiones: 89 mm (3½") de diámetro, 64 mm (2½") de alto

Entradas para sensores: Uno

Fuente de alimentación: Una pila alcalina de 9 voltios (use dos pilas para una mayor duración de las pilas).

Temperatura de funcionamiento: -17 °C a 60 °C o 0 °F a 140 °F

Aprobaciones:

IP68

CE

FCC

C-Tick

TABLE DES MATIÈRES

FR

CARACTERISTIQUES DU NODE	2
COMPOSANTS DE NODE	3
Boutons de commande	
Ecran LCD	
CONNEXION DE LA OU DES PILES	4
FIXATION DES SOLENOIDES	5
Câblage des solénoïdes à impulsion au NODE.	
Pour monter le NODE sur une électrovanne (Figure 1)	
FIXATION DU NODE	6
CONNEXION D'UNE SONDE METEOROLOGIQUE	6
Réglage de la date et de l'heure	
MODE DE VEILLE	7
MODE DE FONCTIONNEMENT	7
PROGRAMMATION	7
Définition des heures de démarrage de l'arrosage	
Définition des temps de fonctionnement	
Définition des jours d'arrosage	
Sélection de l'arrosage les jours pairs ou impairs	
Sélection du nombre de jours d'intervalle entre les arrosages	
Définition du réglage saisonnier	
Mise hors tension du système	
Arrosage manuel	
Fonctionnement du capteur	
FONCTIONNALITÉS DE PROGRAMMATION AVANCÉES	12
Définition de la sonde	
Mémoire Easy Retrieve	
Réglage du fonctionnement de l'électrovanne maîtresse (modèles NODE-200, NODE-400 et NODE-600 uniquement)	
Arrêt programmable (jusqu'à 99 jours)	
Procédure Quick Check de Hunter	

INDICATEUR DE DURÉE DE VIE DE LA PILE	14
RÉINITIALISATION DU PROGRAMMATEUR	14
GUIDE DE DEPANNAGE	15
CARACTÉRISTIQUES	16
NOTES	17

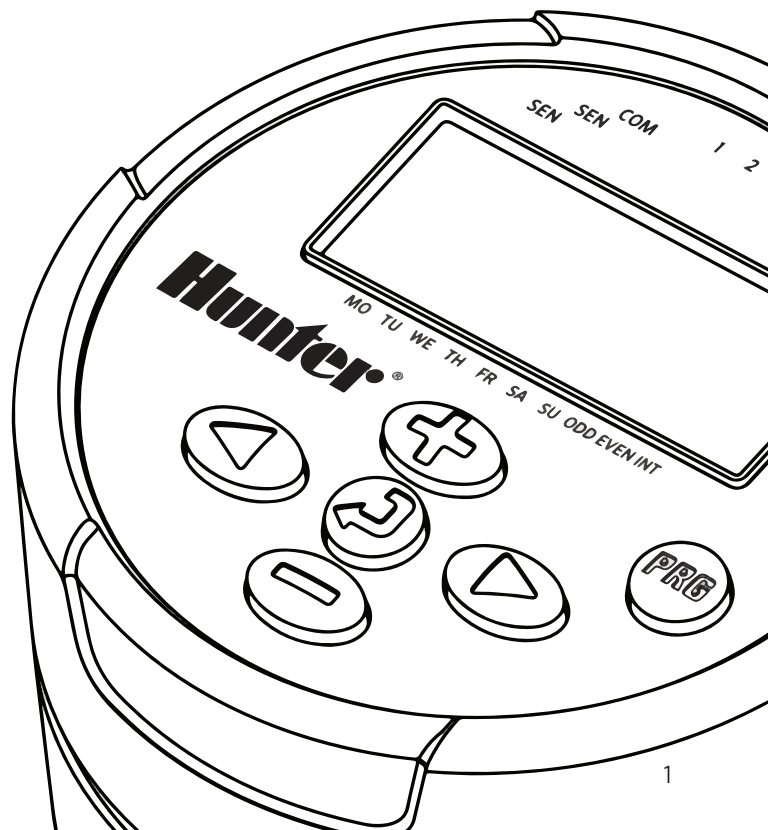

- Programmation à l'aide d'un simple bouton.
- Modèle à une seule station (NODE-100) avec solénoïde à impulsion CC. Des modèles à une, deux, quatre ou six stations sont également disponibles (solénoïdes non inclus).
- Grand écran à cristaux liquides (LCD) avec des icônes intuitives.
- Fonctionne avec au moins une pile alcaline neuf volts standard (utilisez-en deux pour accroître la durée de vie de la pile).
- Trois programmes (A, B ou C) comprenant jusqu'à quatre heures de démarrage chacun.
- Durées d'arrosage allant d'une minute à six heures.
- Capacités d'arrosage manuel.
- Indicateur de durée de vie de la pile.
- Compatible avec les sondes de pluie câblées.
- Mémoire non volatile qui conserve toutes les données de programmation.
- Réglage saisonnier de 10 à 150%.
- La mémoire Easy Retrieve™ permet d'enregistrer/de récupérer les données de votre programme préféré.
- Contournement manuel de la sonde de pluie.
- Calculatrice de temps de fonctionnement total qui affiche la durée totale de programme d'arrosage par programme.

Cette section présente certains composants du NODE. Chaque élément sera abordé plus en détails dans les chapitres suivants. Toutefois, cette section vous aidera à vous familiariser aux différentes options disponibles.

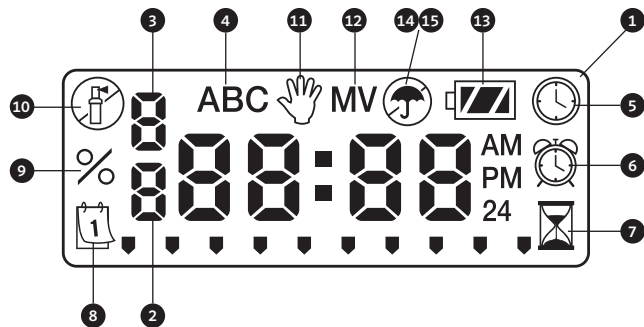

Boutons de commande

- ➕ **Bouton** : augmente la valeur clignotante à l'écran.
- ➖ **Bouton** : diminue la valeur clignotante à l'écran.
- ⏸ **Bouton** : sélectionne la fonction de programmation.
- ▶ **Bouton** : passe à la valeur clignotante à l'écran suivante.
- ◀ **Bouton** : revient à la valeur clignotante à l'écran précédente.
- Ⓜ **Bouton** : sélectionne le programme (A, B ou C).

Ecran LCD

- Ecran principal** : affiche toutes les informations du programme.
- Numéro de station** : indique le numéro de station en cours de programmation.
- Numéro d'heure de démarrage** : indique le numéro d'heure de démarrage en cours de programmation.
- Programme** : indique le programme (A, B ou C).
- Heure/jour** : signale le réglage de la date/de l'heure.
- Heures de démarrage** : signale le réglage des heures de démarrage.
- Temps de fonctionnement** : signale le réglage des temps de fonctionnement. Permet à l'utilisateur de paramétrer des durées d'arrosage allant d'une minute à six heures.
- Jours d'arrosage** : permet à l'utilisateur de choisir des jours d'arrosage individuels ou de définir un certain nombre de jours (intervalle) entre chaque arrosage.
- % d'ajustement saisonnier** : permet de programmer les ajustements saisonniers de 10 à 150 % (la valeur par défaut est 100 %).
- Système désactivé** : signale que l'arrosage est suspendu.
- Manuel On/Off** : signale lorsque l'arrosage manuel est programmé. Permet à l'utilisateur d'activer la station manuellement.
- MV** : Indique que la station une est paramétrée en tant qu'électrovanne principale (uniquement disponible sur les modèles à deux, quatre ou six stations).
- Etat de la pile** : signale l'autonomie restante de la pile.
- Parapluie** : signale que le capteur de pluie a suspendu l'arrosage.
- Parapluie barré** : signale que le capteur de pluie a été contourné manuellement.

CONNEXION DE LA OU DES PILES

FR

Le NODE utilise une ou deux piles neuf volts standard (non incluses) pour activer les électrovannes et programmer le programmeur. Le programmeur peut fonctionner à l'aide d'une seule ou de deux piles neuf volts. Dans des conditions normales, la durée de vie attendue est d'un an avec une seule pile et de deux ans avec deux piles neuf volts.



REMARQUE : La mémoire du NODE est non volatile. Cela permet de retirer la pile sans perdre les informations de programmation.

Pour installer la ou les piles

1. Dévissez la partie arrière du corps du NODE afin d'ouvrir le compartiment à piles.
2. Introduisez la ou les piles dans le support de pile, puis raccordez-les au programmeur à l'aide du connecteur de piles.
3. Vérifiez qu'il n'y a pas d'eau dans le compartiment à piles.
4. Revissez la partie arrière du NODE sur la partie avant.



REMARQUE : Assurez-vous que le marqueur d'étanchéité à l'arrière du NODE est aligné sur la moitié avant, de manière à garantir une étanchéité adéquate.

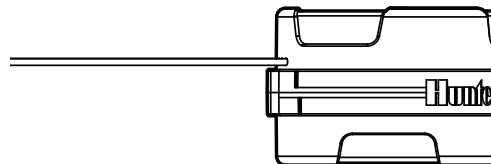
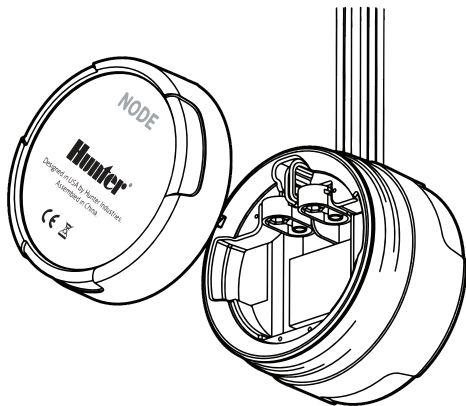

FIXATION DES SOLENOIDES

FR

Le NODE-100 est livré avec un solénoïde connecté au programmeur. Le NODE-100-LS ne comprend pas de solénoïde. Les programmeurs à plusieurs stations NODE-200, NODE-400 et NODE-600 peuvent activer respectivement deux, quatre ou six solénoïdes. Les solénoïdes à impulsion CC de Hunter (référence 458200) peuvent être facilement installés sur toutes les électrovannes Hunter en plastique.



REMARQUE : Utilisez des solénoïdes à impulsion CC fonctionnant à 9-11 V c.c. Les solénoïdes 24 V c.a. ne fonctionneront pas avec le NODE.

Câblage des solénoïdes à impulsion au NODE

1. Attachez les fils noirs de chaque solénoïde au seul câble neutre (fil noir) en provenance du NODE. Réalisez toutes les connexions à l'aide de connecteurs étanches.
2. Attachez un fil rouge de chaque solénoïde au câble de la station correspondante (fil rouge) en provenance du NODE. Les numéros de station figurent sur la face du NODE. Réalisez toutes les connexions à l'aide de connecteurs étanches.



REMARQUE : La longueur maximale des câbles entre le solénoïde et le NODE est le 30 m (100') à l'aide d'un fil de calibre 1 mm (18 AWG) au minimum.

Câble neutre (fils noirs)

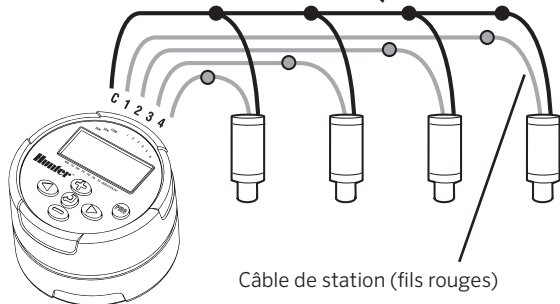

Câble de station (fils rouges)

FIXATION DU NODE

Le NODE peut être monté facilement sur n'importe quelle électrovanne en plastique de Hunter. Cette installation est simplifiée grâce à l'existence d'une bride spéciale de fixation sur électrovanne. Un film en caoutchouc protège la face du NODE contre l'accumulation de saletés.

Pour monter le NODE sur une électrovanne (Figure 1)

1. Vissez le solénoïde à impulsion CC Hunter (référence 458200) au chapeau de l'électrovanne.
2. Installez la petite extrémité ouverte du support du NODE au-dessus du solénoïde.
3. Insérez le programmeur NODE dans la grande extrémité ouverte du support du NODE.

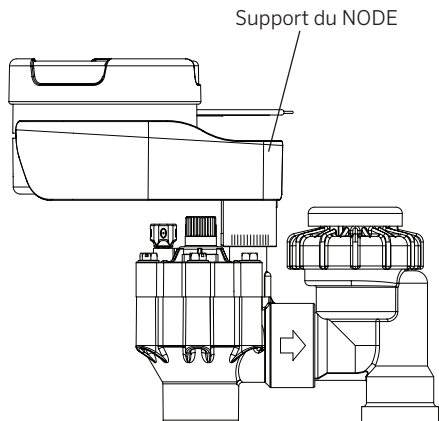

Figure 1

CONNEXION D'UNE SONDE METEOROLOGIQUE

FR

Une sonde de pluie Mini-Clik® o Rain-Clik® câblée de Hunter peut être connectée au NODE. L'objectif de ce capteur est d'interrompre l'arrosage lorsque les conditions météorologiques l'imposent.



REMARQUE : Lorsque la sonde de pluie câblée interrompt l'arrosage, l'écran affiche l'icône d'arrêt du système ☹️, « OFF » et sur l'écran ☂️.

1. Coupez la boucle du câble jaune attaché au NODE au milieu de la boucle.
2. Retirez environ 13 mm (1/2") d'isolant de chaque câble. Raccordez un câble jaune à chacun des câbles de la sonde météorologique. Vous pouvez fixer la sonde de pluie jusqu'à 30 m (100') du programmeur NODE (fil de calibre 1 mm/18 AWG minimum).
3. Réalisez les connexions à l'aide de connecteurs étanches.

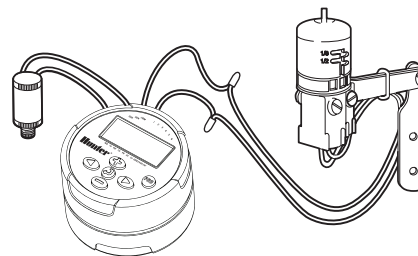

Hunter modèle Mini-Clik®

MODE DE VEILLE

Normalement, l'écran du NODE affiche l'heure du jour, le jour de la semaine, MV (si l'option d'électrovanne principale est activée), ainsi que l'indicateur de durée de vie de la pile. Après une brève période d'inactivité, l'écran s'éteint pour conserver l'alimentation de la pile. Appuyez sur n'importe quel bouton pour faire sortir le NODE du mode veille.

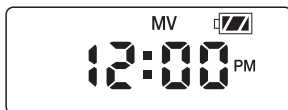





MODE DE FONCTIONNEMENT

Lorsque le programmeur active un programme, les éléments affichés sur l'écran incluent le numéro de la station, la lettre du programme, la durée d'arrosage restante et l'icône en forme d'arroseur qui clignote.

















PROGRAMMATION







FR

Le NODE utilise une programmation typique des programmeurs Hunter, avec trois programmes (A, B ou C) et quatre heures de démarrage par programme. Sur les programmeurs Hunter standard se trouve un sélecteur qui permet de faire défiler les fonctions de programmation. Cependant, sur le NODE, c'est le bouton  qui sert à rapidement et facilement créer le programme d'arrosage. Lors de la programmation, vous pouvez modifier la partie de l'écran qui clignote en appuyant sur le bouton  ou . Pour modifier une valeur qui ne clignote pas, appuyez sur le bouton  ou  jusqu'à ce que l'élément souhaité clignote.









Réglage de la date et de l'heure

1. Appuyez sur le bouton  jusqu'à ce que l'icône  s'affiche.
2. Les quatre chiffres qui s'affichent représentent l'année. Appuyez sur le bouton  ou  pour changer l'année. Appuyez sur le bouton  pour passer au réglage du mois.
3. Les quatre chiffres s'affichent, les deux de gauche représentant le mois et clignotant. Appuyez sur le bouton  ou  pour changer le mois. Appuyez sur le bouton  pour passer au réglage du jour.
4. Seuls deux chiffres clignotent à droite. Ils représentent le jour. Appuyez sur le bouton  ou  pour changer le jour. Appuyez sur le bouton  pour changer l'heure. Appuyez sur le bouton  pour passer au réglage de l'heure.
5. À présent, le paramètre horaire AM/PM/24 heures clignote. Appuyez sur le bouton  ou  pour sélectionner le mode AM, PM ou 24 heures. Appuyez sur le bouton  pour passer au réglage de l'heure.

6. Les quatre chiffres s'affichent, les deux de gauche représentant l'heure et clignotant. Appuyez sur le bouton  ou  pour changer l'heure. Appuyez sur le bouton  pour passer au réglage des minutes.
7. Les quatre chiffres s'affichent, les deux de droite représentant les minutes et clignotant. Appuyez sur le bouton  ou  pour changer les minutes. Si vous appuyez sur le bouton  vous retournerez au réglage de l'année de l'étape 2.
8. Appuyez sur le bouton  pour passer à la fonction de programmation suivante ou pour revenir au mode de veille du programmeur.



Définition des heures de démarrage de l'arrosage







1. Appuyez sur le bouton  jusqu'à ce que l'icône  s'affiche.
2. L'heure de démarrage s'affiche et clignote, ainsi que la lettre du programme (A, B, or C) et le numéro d'heure de démarrage (1, 2, 3, ou 4), dans le coin supérieur gauche de l'écran. Vous pouvez configurer jusqu'à quatre heures de démarrage différentes pour chaque programme.
3. Appuyez sur le bouton  ou  pour changer l'heure de démarrage du programme affiché. Chaque fois que vous appuyez sur le bouton, l'heure de démarrage change par incréments d'une minute.
4. Appuyez sur le bouton  pour ajouter une heure de démarrage supplémentaire au programme affiché. Le numéro d'heure de démarrage apparaît dans le coin supérieur gauche de l'écran.
5. Appuyez sur le bouton  pour ajouter des heures de démarrage à un autre programme.

6. Appuyez sur le bouton  pour passer à la fonction de programmation suivante ou pour revenir au mode de veille du programmeur.



REMARQUE : une fois que le temps de fonctionnement de la dernière station aura été programmé, appuyez sur le bouton  afin d'afficher le temps de fonctionnement total du programme.

Définition des temps de fonctionnement

1. Appuyez sur le bouton  jusqu'à ce que l'icône  s'affiche.
2. Le temps de fonctionnement clignote à l'écran. La lettre du programme est également indiquée (A, B ou C) ainsi que le numéro de la station active dans le coin inférieur gauche de l'écran. Appuyez sur le bouton  ou  pour modifier la durée d'arrosage de la station d'une minute à six heures.
3. Appuyez sur le bouton  pour passer à la station suivante.
4. Appuyez sur le bouton  pour ajouter un temps de fonctionnement à un autre programme.
5. Appuyez sur le bouton pour passer à la fonction de programmation suivante ou pour revenir au mode de veille du programmeur.



Définition des jours d'arrosage

1. Appuyez sur le bouton jusqu'à ce que l'icône s'affiche.
2. La lettre du programme (A, B ou C) s'affiche.
3. Les flèches pointent vers les jours de la semaine lors desquels aura lieu un arrosage. Appuyez sur le bouton ou pour faire défiler les jours.
4. Appuyez sur le bouton pour activer ce jour pour le programme affiché. Appuyez sur le bouton pour annuler l'arrosage ce jour-là. **Une flèche apparaît sur les jours d'arrosage pour le programme actif.**
5. Appuyez sur le bouton pour définir les jours d'arrosage d'un autre programme, le cas échéant.
6. Appuyez sur le bouton pour passer à la fonction de programmation suivante ou pour revenir au mode de veille du programmeur.

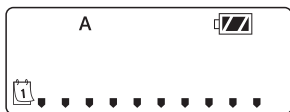

Sélection de l'arrosage les jours pairs ou impairs

Cette fonction se base sur la date du mois et non sur le jour de la semaine pour l'arrosage.

1. Appuyez sur le bouton jusqu'à ce que l'icône s'affiche.
2. Appuyez sur le bouton jusqu'à ce que le curseur se trouve au-dessus de ODD (impair) ou EVEN (pair) à l'écran.
3. Appuyez sur le bouton pour sélectionner un jour pair ou impair pour l'arrosage ou sur pour annuler la sélection.
4. Une fois que le mode IMPAIR ou PAIR est activé, c'est le seul curseur qui sera visible.

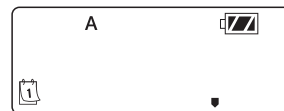

Sélection du nombre de jours d'intervalle entre les arrosages

1. Appuyez sur le bouton jusqu'à ce que l'icône s'affiche.
2. Appuyez sur le bouton jusqu'à ce que le curseur se trouve au-dessus de INT à l'écran.
3. Appuyez sur le bouton et le chiffre 1 clignote. Il indique le nombre de jours entre chaque arrosage.
4. Appuyez sur le bouton ou pour sélectionner le nombre de jours entre les arrosages (de 1 à 31).

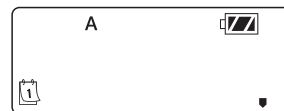



Définition du réglage saisonnier

1. Appuyez sur le bouton jusqu'à ce que l'icône s'affiche.
2. Appuyez sur le bouton ou pour augmenter ou réduire la valeur du réglage saisonnier par rapport à la valeur par défaut de 100% (minimum de 10 % ou maximum de 150 %).

3. La valeur programmée pour le réglage saisonnier est appliquée à l'ensemble des programmes d'arrosage et elle est immédiatement prise en compte par les temps de fonctionnement affichés. Par exemple, si des durées d'arrosage de 20 minutes sont programmées puis que le réglage saisonnier est modifié de 100 % à 50 %, les durées d'arrosage affichées seront de 10 minutes.





Mise hors tension du système









Pour mettre le programmeur hors tension, appuyez sur le bouton  jusqu'à ce que l'icône  et **Off** soient affichés. Pour réactiver le mode de programmation automatique du programmeur, appuyez sur le bouton . Le programmeur retournera immédiatement en mode de programmation automatique et affichera l'heure ainsi que l'indicateur de durée de vie de la pile.



Arrosage manuel





L'arrosage manuel permet à l'utilisateur de tester chaque station ou un programme pendant un temps de fonctionnement précis. L'état de la sonde météorologique (le cas échéant) sera ignoré dans ce mode.

1. Veillez à ce que le programmeur soit en mode veille. Maintenez le bouton  enfoncé jusqu'à ce que l'icône  s'affiche.
2. Le numéro de station apparaît dans le coin inférieur gauche de l'écran, ainsi que le temps de fonctionnement.

3. Sélectionnez la station souhaitée à l'aide des boutons  ou , puis réglez la durée d'arrosage manuel pour la station indiquée à l'aide des boutons  et .
4. Pour activer un programme manuellement, appuyez sur le bouton . La lettre du programme (A, B ou C) s'affiche. Si vous avez besoin d'un programme différent, appuyez sur le bouton  jusqu'à ce que le programme souhaité s'affiche.
5. Pour arrêter le cycle d'arrosage manuel, appuyez sur le bouton  jusqu'à ce que la durée soit égale à zéro.
6. Appuyez sur le bouton  pour passer à la fonction de programmation suivante ou pour revenir au mode de veille du programmeur.



REMARQUE:

- Si vous appuyez sur le bouton  ou  alors qu'une station est en cours d'arrosage manuel, cela modifiera la durée d'arrosage de cette station.
- Si vous appuyez sur le bouton  alors qu'une station fonctionne en mode d'arrosage manuel, l'arrosage sera interrompu sur la station en cours et passera à la station suivante.
- Si vous appuyez sur le bouton  alors qu'une station fonctionne en mode d'arrosage manuel, l'arrosage sera interrompu sur la station en cours et reviendra à la station antérieure.

Fonctionnement du capteur

Le NODE est compatible avec les sondes de pluie de type Clik de Hunter, notamment les Mini-Clik®, Freeze-Clik et Rain-Clik® câblée, ainsi que de nombreux autres appareils/sondes d'interruption qui ne nécessitent pas d'alimentation. Il suffit de raccorder le capteur au programmeur NODE en coupant le câble jaune en boucle et en le connectant aux câbles du capteur.



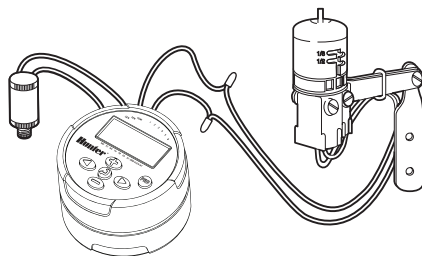

REMARQUE : NODE n'est pas compatible avec le capteur sans fil Rain-Clik® de Hunter ou tout autre appareil météorologique qui requiert une alimentation électrique de 24 volts.

Quand le capteur est activé, il suspend l'arrosage et l'icône ☂ s'affiche.





Toutes les fonctions de programmation avancées sont initiées à partir du mode veille, qui affiche l'heure, le jour de la semaine et l'indicateur de durée de vie de la pile sur l'écran. Quand un élément clignote à l'écran, cela signifie que le programmeur est dans un des modes de programmation. Après une brève période d'inactivité, le programmeur retournera en mode veille.



Dérivation de la sonde

1. À partir du mode veille, maintenez enfoncé le bouton  enfoncé jusqu'à ce que l'icône  s'affiche.
2. L'icône clignotante de parapluie et **On** s'affichent.



3. Appuyez sur le bouton  pour activer la dérivation de la sonde. L'écran affiche  et **Off**, pour indiquer que la sonde météorologique est contournée. L'icône  s'affiche pendant le fonctionnement normal, ce qui indique que le programmeur est en mode de dérivation.





4. Pour activer à nouveau la sonde météorologique, maintenez le bouton  enfoncé jusqu'à ce que l'icône  s'affiche. Appuyez sur le bouton  pour revenir au mode de sonde normal.

Mémoire Easy Retrieve



Cette fonction permet à l'utilisateur d'enregistrer dans la mémoire permanente du programmeur un programme préféré, qui pourra être restauré à tout moment. C'est une excellente manière d'écraser des modifications introduites et de revenir à la programmation d'origine.

Pour enregistrer un programme

1. Assurez-vous que le programmeur est programmé selon la programmation préférée.
2. À partir du mode veille, maintenez enfoncés les boutons  et  pendant cinq secondes afin d'enregistrer le programme en cours.
3. L'écran affichera trois lignes en pointillés se déplaçant de gauche à droite pour indiquer que le programme actuel est en cours d'enregistrement dans la mémoire permanente. **Done** (terminé) clignote à l'écran pour signaler que le processus est terminé.



Pour récupérer un programme enregistré :

1. À partir du mode veille, maintenez enfoncés les boutons  et  pendant cinq secondes.
2. L'écran affichera trois lignes en pointillés se déplaçant de droite à gauche pour indiquer que le programme préféré est en cours de récupération dans la mémoire.



Le programme favori est désormais le programme actif du programmeur. **Done** (terminé) clignote à l'écran pour signaler que le processus est terminé.



REMARQUE : Soyez attentif lors de l'utilisation de la mémoire Easy Retrieve. L'enregistrement des données d'un programme à l'aide d'Easy Retrieve prendra les informations du programme actif et écrasera tout ce qui se trouve dans la mémoire permanente. Au moment d'enregistrer les données d'un programme, assurez-vous que les données du programme actif correspondent à vos souhaits.

Réglage du fonctionnement de l'électrovanne maîtresse (modèles NODE-200, NODE-400 et NODE-600 uniquement)

Les modèles de NODE à plusieurs stations (NODE-200, NODE-400 et NODE-600) peuvent être programmés à l'aide d'une électrovanne principale normalement fermée. Dans le cadre de la programmation avec l'électrovanne maîtresse, vous désignez la station 1 en tant qu'électrovanne maîtresse, ce qui signifie que la station 1 n'est plus disponible pour l'activation d'une station d'arrosage.

1. À partir du mode veille, appuyez sur le bouton  jusqu'à ce que l'icône  s'affiche.
2. Le programme A s'affichera, ainsi que le numéro de la station active, dans le coin inférieur gauche. Assurez-vous que la station active indiquée est "1".





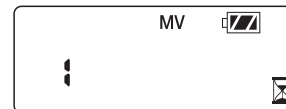

3. Appuyez une fois sur la touche  ; l'icône **MV** s'affiche et la durée disparaît. La station 1 fait désormais office d'électrovanne maîtresse et elle ne sera pas disponible dans les autres écrans de programmation.



4. Quand l'électrovanne maîtresse est activée, elle s'applique à tous les programmes et l'icône **MV** reste à l'écran en permanence.

Arrêt programmable (jusqu'à 99 jours)

Cette fonction permet à l'utilisateur d'arrêter tous les arrosages programmés pendant la période désignée, comprise entre 1 et 99 jours. À la fin de la période d'arrêt programmable, le programmeur reprend le fonctionnement normal.

1. À partir du mode veille, appuyez sur le bouton  jusqu'à ce que l'icône  s'affiche. Attendez deux secondes jusqu'à ce que **Off** s'affiche. Le programmeur est désormais en mode de système désactivé.
2. Appuyez sur le bouton , un "1" clignotant s'affichera, indiquant le nombre de jours pendant lesquels le programmeur restera éteint. Programmez le nombre de jours d'arrêt en fonction des besoins, le maximum étant limité à 99 jours.
3. L'écran affiche le nombre de jours restant dans la période d'arrêt.
4. Pour interrompre la période d'arrêt, appuyez sur le bouton  afin de retourner à l'écran du mode veille, qui indiquera l'heure du jour et le jour de la semaine.

INDICATEUR DE DURÉE DE VIE DE LA PILE

Il est possible d'estimer la durée de vie restante de la pile à l'aide de l'indicateur de durée de vie de la pile qui s'affiche sur l'écran. Le NODE peut fonctionner à l'aide d'une seule ou de deux piles neuf volts. Le recours à deux piles neuf volts doublera plus ou moins la durée de vie de la pile par rapport à une seule pile neuf volts. Le diagramme de l'indicateur de durée de vie de la pile ci-dessous montre une estimation de la durée de vie restante de la pile.

 Complet : 100 à 60 % d'autonomie restante







 Moyen : 60 à 25 % d'autonomie restante

 Faible : 25 à 0 % d'autonomie restante

 Remplacez la pile sur le champ !

RÉINITIALISATION DU PROGRAMMATEUR

La réinitialisation du programmeur effacera les données du programme active et redémarrera le programmeur. Toutefois, une réinitialisation ne supprime pas un programme enregistré dans la mémoire permanente via la fonction Easy Retrieve (voir page 12) pour enregistrer un programme favori.

1. À partir du mode veille, maintenez les boutons ,  et  enfoncés.
2. L'écran devient vide après deux secondes. Maintenez toujours les boutons ,  et  enfoncés.
3. 12:00 clignote à l'écran. Relâchez les boutons.
4. Il se peut que le programmeur affiche un compte à rebours de 10 à 1, puis 12:00 AM clignotera lorsque la réinitialisation sera terminée. Le programmeur peut être reprogrammé.

Problème	Causes	Solutions
Pas d'affichage.	L'écran est éteint. La pile est épuisée.	Appuyez sur n'importe quel bouton pendant une seconde. Remplacez la pile.
L'écran indique que l'arrosage est en cours, mais rien ne se passe.	Pas de pression d'eau. Solénoïde défectueux. Solénoïde non compatible.	Ouvrez le système d'alimentation principal. Remplacez le solénoïde. Il faut utiliser un solénoïde à impulsion (n° de réf. 458200) de Hunter ou un autre solénoïde à impulsion compatible.
L'arrosage automatique ne commence pas à l'heure prévue.	Le programmeur est en mode de système désactivé. Le paramètre AM/PM de l'heure n'a pas été configuré correctement. Le paramètre AM/PM de l'heure de démarrage n'a pas été configuré correctement.	Assurez-vous que le programmeur est programmé pour l'arrosage automatique. Rectifiez le paramètre AM/PM de l'heure. Rectifiez le paramètre AM/PM de l'heure de démarrage.
Le capteur de pluie ne suspend pas l'arrosage.	Capteur de pluie défectueux ou mauvais câblage	Vérifiez le bon fonctionnement du capteur de pluie et les raccordements des câbles (cf. page 10).
Le programmeur arrose plus d'une fois.	Plusieurs heures de démarrage sont attribuées au programme. Chaque programme peut avoir jusqu'à quatre heures de démarrage.	Éliminez les heures de démarrage du programme selon les besoins.

CARACTÉRISTIQUES

FR

Dimensions : 3 ½"(89 mm) diamètre, 2 ½"(64 mm) hauteur

Entrées de sonde : Une

Source d'alimentation : Une pile alcaline neuf volts standard (utilisez-en deux pour accroître la durée de vie de la pile). Active les solénoïdes à impulsion Hunter fonctionnant en 9 volts (n° de réf. Hunter 458200)

Température de fonctionnement : De 0 °F à 140 °F ou -17 °C à 60 °C

Approbatons :

IP68

CE

FCC

C-Tick

FUNZIONI NODE	2
COMPONENTI DEL NODE	3
Pulsanti di comando	
Display LCD	
COLLEGAMENTO DELLA BATTERIA/BATTERIE	4
COLLEGAMENTO DEI SOLENOIDI	5
Per cablare i solenoidi cc su NODE	
Per installare NODE su una valvola (Figura 1)	
INSTALLAZIONE DI NODE	6
COLLEGAMENTO DI UN SENSORE ATMOSFERICO	6
Impostazione di data e ora	
MODALITÀ ATTESA	7
MODALITÀ FUNZIONAMENTO	7
PROGRAMMAZIONE	7
Impostazione degli orari di partenza dell'irrigazione	
Impostazione dei tempi di funzionamento	
Impostazione dei giorni di irrigazione	
Impostazione della irrigazione secondo giorni dispari/pari	
Scelta dei giorni di intervallo per l'irrigazione	
Impostazione della regolazione stagionale	
Spegnimento del sistema	
Irrigazione manuale	
Funzionamento sensore	
FUNZIONI DI PROGRAMMAZIONE AVANZATE	12
Bypass del sensore	
Memoria Easy Retrieve	
Impostazione del funzionamento valvola principale (solo NODE-200, NODE-400 e NODE-600)	
Spegnimento programmabile (fino a 99 giorni)	
Hunter Quick Check	

INDICATORE DURATA BATTERIA	14
RESETTAGGIO DEL PROGRAMMATORE	14
GUIDA ALLA RISOLUZIONE DEI PROBLEMI	15
SPECIFICHE	16
NOTE	17

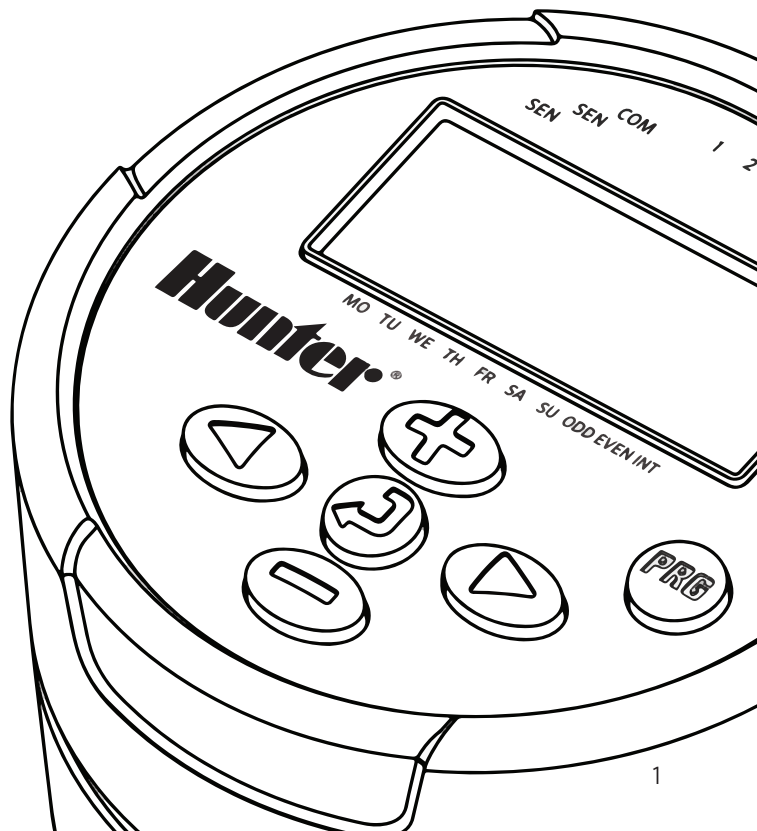

- Programmazione con il semplice tocco di un pulsante
- Modello a stazione singola (NODE-100) con solenoide bistabile CC. Sono disponibili anche modelli a una, due, quattro o sei stazioni (solenoidi non inclusi).
- LCD di grandi dimensioni con icone di facile utilizzo
- Funziona con almeno una batteria a 9 V standard (usarne due per aumentare la durata)
- Tre programmi (A, B o C), ognuno con un massimo di quattro orari di avvio
- Tempi di irrigazione da un minuto a sei ore
- Funzionalità di irrigazione manuale
- Indicatore durata batteria
- Compatibile con sensori pioggia cablati
- Memoria permanente per tutti i dati di programma
- Regolazione stagionale dal 10 al 150%
- La memoria Easy Retrieve™ consente di salvare/recuperare i dati dei programmi preferiti
- Esclusione manuale del sensore pioggia
- Calcolatore del tempo totale di funzionamento che mostra il tempo di irrigazione totale per ogni programma

In questa sezione viene fornita una panoramica di alcuni componenti del programmatore NODE. Ogni elemento verrà analizzato in dettaglio successivamente. Questa sezione può comunque essere utile per conoscere le varie opzioni disponibili.

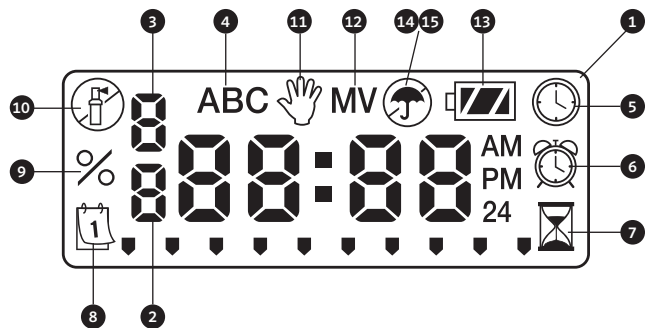

Pulsanti di comando

1. **Pulsante** - Aumenta la visualizzazione lampeggiante selezionata
2. **Pulsante** - Riduce la visualizzazione lampeggiante selezionata
3. **Pulsante** - Seleziona la funzione di programmazione
4. **Pulsante** - Passa all'elemento successivo della visualizzazione lampeggiante selezionata
5. **Pulsante** - Passa all'elemento precedente della visualizzazione lampeggiante selezionata
6. **Pulsante** - Seleziona il programma (A, B o C)

Display LCD

1. **Schermo principale** - Mostra le impostazioni dei programmi
2. **Numero stazione** - Indica il numero di stazione in fase di programmazione
3. **Numero partenza** - Indica il numero della partenza in fase di programmazione
4. **Programma** - Indica il programma (A, B o C)
5. **Ora/giorno corrente** - Indica l'impostazione dell'ora/giorno corrente
6. **Partenze ciclo** - Indica l'impostazione degli orari di partenza
7. **Tempi di funzionamento** - Indica l'impostazione dei tempi di funzionamento. Consente di impostare tempi di irrigazione da un minuto a sei ore.
8. **Giorni di irrigazione** - Permette all'utente di selezionare singole giornate per l'irrigazione, oppure un numero di giorni di intervallo tra le irrigazioni
9. **% Regolazione stagionale** - Permette di programmare una regolazione stagionale dal 10 al 150% (il valore predefinito è 100%)
10. **Sistema Off** - Indica che l'irrigazione è sospesa
11. **On/Off manuale** - Indica che l'irrigazione manuale è programmata. Permette all'utente di attivare manualmente la stazione.
12. **MV**: indica che la stazione uno è impostata sul funzionamento con valvola principale (disponibile solo sui modelli a due, quattro o sei stazioni)
13. **Stato batteria** - Indica la durata rimanente della batteria
14. **Ombrello** - Indica che il sensore pioggia sta sospendendo l'irrigazione
15. **Ombrello barrato** - Indica che il sensore pioggia è stato escluso manualmente

Il programmatore NODE usa una o due batterie standard a 9 V (non incluse) per il funzionamento delle valvole e la programmazione del programmatore. Il programmatore può funzionare con una o due batterie a 9 V. In normali condizioni, la durata prevista è di un anno per una batteria e due anni con due batterie a 9 V.



NOTA: NODE dispone di una memoria permanente. Consente di rimuovere la batteria senza perdere le informazioni sui programmi.

Per installare le batterie

1. Svitare la sezione posteriore del corpo di NODE per accedere allo scomparto batterie.
2. Inserire la batteria (o le batterie) nell'alloggiamento e collegarla al programmatore tramite l'apposito connettore.
3. Assicurarsi che non vi sia acqua all'interno dello scompartimento batterie.
4. Riavvitare la sezione posteriore di NODE sulla metà frontale.



NOTA: verificare che l'indicatore della guarnizione sulla metà posteriore del programmatore NODE sia allineato con la metà anteriore, controllando che si sia creato una tenuta appropriata.

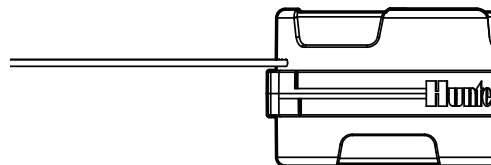
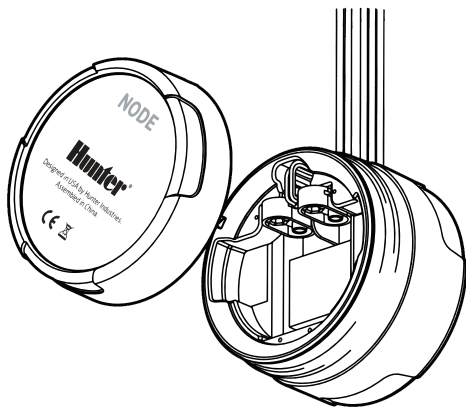

COLLEGAMENTO DEI SOLENOIDI

IT

NODE-100 è fornito con un solenoide collegato al programmatore. NODE-100-LS non include un solenoide. I programmatori NODE-200, NODE-400, e NODE-600 a più stazioni funzioneranno con due, quattro o sei solenoidi, rispettivamente. I solenoidi bistabili CC di Hunter (n. parte 458200) possono essere installati facilmente su tutte le valvole di plastica di Hunter.



NOTA: utilizzare solenoidi bistabili CC 9-11 VDC. I solenoidi a 24 VAC NON sono compatibili con NODE.

Per cablare i solenoidi cc su NODE

1. Collegare i contatti neri provenienti da ogni solenoide all'unico cavo comune (contatto nero) proveniente da NODE. Fissare tutti i collegamenti dei cavi con connettori impermeabili.
2. Collegare un filo rosso provenienti da ogni solenoide al corrispondente cavo della stazione (contatto rosso) proveniente da NODE. I numeri delle stazioni sono identificati sul frontale di NODE. Fissare tutti i collegamenti dei cavi con connettori impermeabili.



NOTA: la distanza dei cavi massima tra il solenoide e NODE è 30 m (100') con una dimensione dei cavi minima di 1 mm (18 AWG).

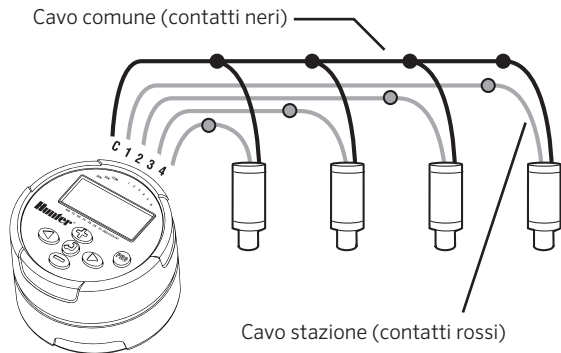

INSTALLAZIONE DI NODE

NODE può essere facilmente installato su qualsiasi valvola in plastica Hunter. L'installazione è facilitata da un apposito fermaglio per il montaggio sulle valvole. Lo speciale coperchio in gomma in dotazione impedisce l'accumulo di detriti sullo schermo di NODE.

Per installare NODE su una valvola (Figura 1)

1. Avvitare il solenoide bistabile CC di Hunter (n. parte 458200) nel coperchio della valvola.
2. Collocare la piccola estremità aperta del supporto di NODE sulla parte superiore del solenoide.
3. Collocare il programmatore NODE nella grande estremità aperta del supporto di NODE.



Figura 1

COLLEGAMENTO DI UN SENSORE ATMOSFERICO

È possibile collegare un sensore pioggia Hunter Mini-Clik® o Rain-Clik® cablato al programmatore NODE. Questo sensore ha lo scopo di interrompere l'irrigazione quando le condizioni meteorologiche lo richiedono.

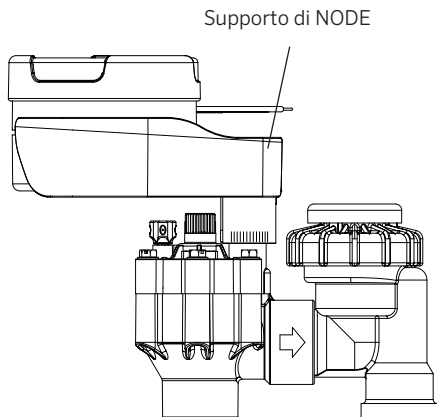

NOTA: quando il sensore pioggia cablato interrompe l'irrigazione, sul display verrà mostrata l'icona di impianto spento , "OFF" e .

1. Tagliare l'anello di filo giallo di NODE a metà circa dell'anello.
2. Spellare 13 mm di isolante dalle estremità da ogni cavo. Collegare un cavo giallo ad ognuno dei due cavi del sensore pioggia. È possibile installare il sensore pioggia a una distanza massima di 30 m (100 piedi) dal programmatore NODE (dimensione dei cavi minima di 1 mm/18 AWG).
3. Usare connettori stagni per fare i collegamenti.

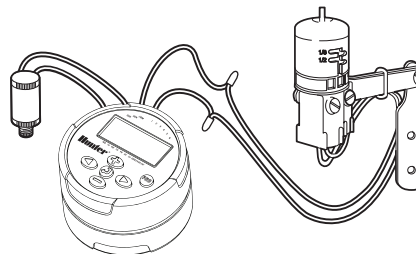

Modello Hunter Mini-Clik®

MODALITÀ ATTESA

In genere, il display di NODE mostra l'ora del giorno, il giorno della settimana, MV (se l'opzione valvola principale è attivata) e l'indicatore durata batteria. Dopo un breve periodo di inattività, il display viene spento per allungare la durata della batteria. La pressione di qualsiasi pulsante disattiverà la modalità di inattività del programmatore NODE.

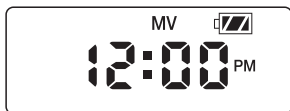





MODALITÀ FUNZIONAMENTO

Quando il programmatore esegue un programma, gli elementi mostrati sul display includono il numero della stazione, la lettera del programma, il tempo di irrigazione rimanente e l'icona lampeggiante della turbina.

















PROGRAMMAZIONE







IT

NODE è basato sulla programmazione dei programmatori Hunter standard con tre programmi (A, B o C) e quattro orari di avvio per programma. Sui programmatori Hunter standard, è disponibile un selettore che consente di scorrere le funzioni di programmazione. Tuttavia, su NODE il pulsante  viene utilizzato per creare il programma di irrigazione in tutta semplicità e rapidità. Durante la programmazione, la parte lampeggiante del display può essere cambiata premendo i pulsanti  o . Per modificare qualcosa presente sullo schermo che non lampeggia, premere i pulsanti  o  fino a fare lampeggiare l'elemento desiderato.









Impostazione di data e ora

1. Premere il pulsante  fino a quando viene visualizzata l'icona .
2. Tutte le quattro cifre visualizzate rappresentano l'anno. Utilizzare i pulsanti  o  per cambiare l'anno. Premere il pulsante  per passare all'impostazione del mese.
3. Tutte le quattro cifre verranno visualizzate con le due cifre a sinistra che rappresentano il mese lampeggiante. Utilizzare i pulsanti  o  per cambiare il mese. Premere il pulsante  per passare all'impostazione del giorno.
4. Lampeggeranno solo le due cifre sul lato destro che rappresentano il giorno. Premere i pulsanti  o  per cambiare il giorno. Premere il pulsante  per passare all'impostazione dell'orario.
5. L'impostazione AM/PM/24 ore viene mostrata lampeggiante. Premere il pulsante  o  per cambiare l'impostazione oraria in AM, PM o 24 ore. Premere il pulsante  per passare all'impostazione dell'ora.

6. Tutti i quattro numeri vengono mostrati con i due numeri a sinistra lampeggianti, che rappresentano l'ora. Utilizzare i pulsanti  o  per cambiare l'ora. Premere il pulsante  per passare all'impostazione dei minuti.
7. Tutti i quattro numeri vengono mostrati con i due numeri a destra lampeggianti, che rappresentano i minuti. Utilizzare i pulsanti  o  per cambiare i minuti. Premere il pulsante  per scorrere l'impostazione dell'anno al passo 2.
8. Premere una volta il pulsante  per procedere alla funzione di programmazione successiva o più volte per riportare il programmatore in modalità di attesa.



Impostazione degli orari di partenza dell'irrigazione







1. Premere il pulsante  fino a quando viene visualizzata l'icona .
2. L'orario di partenza verrà visualizzato lampeggiante, assieme alla lettera del programma (A, B o C) e al numero della partenza (1, 2, 3 o 4) nell'angolo superiore sinistro dello schermo. Per ogni programma è possibile impostare fino a 4 diversi orari di avvio.
3. Utilizzare i pulsanti  o  per cambiare l'orario di partenza per il programma visualizzato. Ogni pressione del pulsante modificherà l'orario di avvio in incrementi di un minuto.
4. Premere il pulsante  per aggiungere un'ulteriore partenza al programma visualizzato. Il numero della partenza che si sta impostando è riportato nell'angolo superiore sinistro dello schermo.
5. Premere il pulsante  per aggiungere impostare partenze in un altro programma.

6. Premere il pulsante  per procedere alla funzione di programmazione successiva o più volte per riportare il programmatore in modalità di attesa.











NOTA: Dopo avere programmato il tempo di funzionamento per l'ultima stazione, premere il pulsante  per visualizzare il tempo totale di funzionamento per il programma.

Impostazione dei tempi di funzionamento

1. Premere il pulsante  fino a quando viene visualizzata l'icona .
2. Il tempo di funzionamento lampeggerà. Vengono mostrati anche la lettera del programma (A, B o C) e il numero di stazione attiva sul lato inferiore sinistro del display. Premere i pulsanti  o  per modificare i tempi di irrigazione da un minuto a sei ore.
3. Premere il pulsante  per passare alla stazione successiva.
4. Premere il pulsante  per aggiungere un tempo di funzionamento in un altro programma.
5. Premere il pulsante  per procedere alla funzione di programmazione successiva o più volte per riportare il programmatore in modalità di attesa.





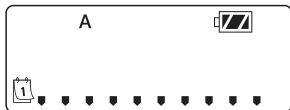

Impostazione dei giorni di irrigazione

1. Premere il pulsante  fino a quando viene visualizzata l'icona .
2. Verrà visualizzata la lettera del programma (A, B o C).
3. Le frecce indicano i giorni specifici della settimana nei quali avrà luogo l'irrigazione. Premere i pulsanti  o  per scorrere fra i giorni.
4. Premere il pulsante  per attivare quel giorno per il programma visualizzato, oppure il pulsante  per annullare l'irrigazione per lo stesso giorno. Le frecce fanno riferimento ai giorni specifici della settimana in cui verrà attivata l'irrigazione.
5. Premere il pulsante  per impostare i giorni di irrigazione per un altro programma, se necessario.
6. Premere il pulsante  per procedere alla funzione di programmazione successiva o più volte per riportare il programmatore in modalità di attesa.







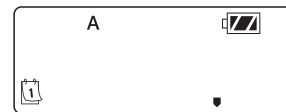

Impostazione della irrigazione secondo giorni dispari/pari

In questo modo si irriga nei giorni pari o dispari secondo una numerazione su base mensile e non settimanale.

1. Premere il pulsante  fino a quando viene visualizzata l'icona .
2. Premere il pulsante  fino a posizionare il cursore su DISPARI o PARI nel display.
3. Premere il pulsante  per selezionare, oppure il pulsante  per annullare i giorni DISPARI o PARI per l'irrigazione.
4. Una volta attivata la modalità DISPARI o PARI, sul display verrà visualizzato solo quel cursore.





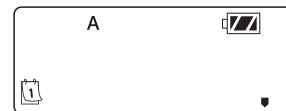

Scelta dei giorni di intervallo per l'irrigazione

1. Premere il pulsante  fino a quando viene visualizzata l'icona .
2. Premere il pulsante  fino a posizionare il cursore su INT nel display.
3. Premere il pulsante , 1 inizierà a lampeggiare a indicare il numero di giorni tra le irrigazioni.
4. Premere i pulsanti  o  per selezionare il numero di giorni tra i giorni di irrigazione (da 1 a 31).





Impostazione della regolazione stagionale

1. Tenere premuto il pulsante  fino a quando viene visualizzata l'icona .
2. Premere il pulsante  o  per aumentare o diminuire il valore della regolazione stagionale rispetto al valore predefinito del 100% (fino a un minimo del 10% o a un massimo del 150%).
3. Il valore programmato per la regolazione stagionale verrà applicato a tutti i programmi di irrigazione e si rispecchierà immediatamente nei tempi di funzionamento visualizzati. Ad esempio, se sono programmati tempi di irrigazione di 20 minuti e la regolazione stagionale viene modificata da 100% a 50%, i tempi di irrigazione visualizzati saranno di 10 minuti.









Spegnimento del sistema





Tenere premuto il pulsante  fino a quando viene visualizzata l'icona  e la scritta **Off** compare sullo schermo. Per riportare il programmatore alla modalità di programmazione auto, premere il pulsante . Il programmatore tornerà immediatamente alla modalità di programmazione automatica e mostrerà l'ora e l'indicatore durata batteria.



Irrigazione manuale





L'irrigazione manuale permette all'utente di collaudare stazioni o programmi per un tempo a scelta. In questa modalità verrà escluso il sensore meteo (se presente).

1. Assicurarsi che il programmatore sia in modalità Attesa. Tenere premuto il pulsante  fino a quando viene visualizzata l'icona .
2. Verrà visualizzato il numero della stazione nell'angolo inferiore sinistro del display, assieme al tempo di funzionamento.
3. Utilizzare i pulsanti  e  per selezionare la stazione desiderata e i pulsanti  e  per impostare il tempo di irrigazione manuale per la stazione indicata.

4. Per attivare manualmente un programma, premere il pulsante . Verrà visualizzata la lettera del programma (A, B o C). Se è richiesto un altro programma, premere il pulsante  fino a visualizzare il programma desiderato.
5. Per interrompere il ciclo di irrigazione manuale, premere il pulsante  fino a ridurre il tempo a zero.
6. Premere il pulsante  per procedere alla funzione di programmazione successiva o per riportare il programmatore in modalità di attesa.



NOTA:

- La pressione dei pulsanti  o  quando una stazione è in modalità di irrigazione manuale modificherà il tempo di irrigazione di tale stazione.
- Premendo il pulsante  mentre una stazione irriga manualmente si interrompe l'irrigazione per la stazione corrente e si passa a quella successiva.
- Premendo il pulsante  mentre una stazione irriga manualmente si interrompe l'irrigazione per la stazione corrente e si torna a quella precedente.

Funzionamento sensore

NODE è compatibile con i sensori pioggia di tipo Hunter Clik, inclusi Mini-Clik®, Freeze-Clik e Rain-Click® cablato, nonché molti altri dispositivi/sensori di tipo a interruzione che non richiedono alimentazione. Collegare semplicemente il sensore al programmatore NODE tagliando l'anello di filo giallo e collegandolo ai cavi del sensore.



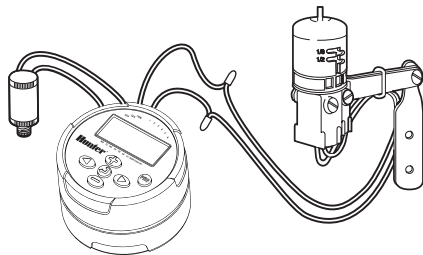

NOTA: NODE non è compatibile con Hunter Wireless Rain-Clik® o altri dispositivi atmosferici che richiedono un'alimentazione a 24 Vca.

Quando verrà attivato il sensore l'irrigazione verrà interrotta e sul display comparirà l'icona .





Tutte le funzioni di programmazione avanzate vengono avviate dalla modalità di inattività, che mostra l'ora, il giorno della settimana e l'indicatore durata batteria sul display. Se sul display lampeggia qualcosa, significa che il programmatore si trova in una delle modalità di programmazione. Dopo un breve periodo di inattività, il programmatore tornerà alla modalità di inattività.



Bypass del sensore

1. Dalla modalità di inattività, premere e tenere premuto il pulsante  finché non viene visualizzata l'icona .
2. Il display mostrerà l'icona dell'ombrello lampeggiante e **On**.



3. Premere il pulsante  per bypassare il sensore. Il display mostrerà  e **Off** per indicare che il sensore meteo è stato escluso. Durante il funzionamento normale nel display verrà visualizzata l'icona , a indicare che il programmatore si trova in modalità bypass.





4. Per riattivare il sensore atmosferico, tenere premuto il pulsante  fino a quando viene visualizzata l'icona . Premere il pulsante  per tornare alla normale modalità sensore.

Memoria Easy Retrieve



Questa funzione consente di salvare un programma preferito nella memoria permanente del programmatore, affinché sia possibile ripristinarlo in qualsiasi momento. Si tratta di un ottimo sistema per annullare eventuali modifiche e ritornare alla programmazione originaria.

Per salvare un programma:

1. Assicurarsi che il programmatore sia impostato con la programmazione desiderata.
2. Dalla modalità di inattività, tenere premuti i pulsanti  e  per cinque secondi per salvare il programma corrente.
3. Verranno mostrate tre linee tratteggiate che si spostano da sinistra verso destra per indicare che il programma corrente è stato salvato nella memoria permanente. Sul display comparirà poi la scritta lampeggiante **Done** quando il processo sarà completato.



Per recuperare un programma salvato:

1. Dalla modalità di inattività, tenere premuti i pulsanti  e  per cinque secondi.
2. Verranno mostrate tre linee tratteggiate che si spostano da destra verso sinistra per indicare che il programma preferito è stato recuperato dalla memoria permanente.

Il programmatore ha ora come programma attivo il programma preferito. Sul display comparirà poi la scritta lampeggiante **Done** quando il processo sarà completato.



NOTA: Prestare attenzione nell'utilizzare la memoria Easy Retrieve. Easy Retrieve salverà i dati del programma corrente sovrascrivendo ciò che era salvato nella memoria permanente. Quando si salvano dei dati assicurarsi che i dati del programma corrente siano effettivamente quelli che si desidera salvare.

Impostazione del funzionamento valvola principale (solo NODE-200, NODE-400 e NODE-600)

I modelli di NODE con più stazioni (NODE-200, NODE-400 e NODE-600) possono essere programmati con l'uso di una valvola principale normalmente chiusa. Quando si adopera questa funzione, verrà assegnata la stazione 1 come valvola principale, perdendo la possibilità di usare la stazione 1 per la normale irrigazione.

1. Dalla modalità di inattività, premere il pulsante finché non viene visualizzata l'icona .
2. Il programma A verrà visualizzato insieme al numero di stazione attivo sulla parte inferiore sinistra. Accertarsi che la stazione attiva visualizzata sia "1". Verrà visualizzato il tempo di funzionamento.



3. Premere una volta il pulsante , sul display verrà visualizzata l'icona **MV** e il tempo scomparirà. La Stazione 1 opererà ora come valvola principale e non sarà disponibile in altre videate di programmazione.

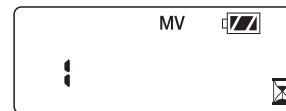

4. Quando la valvola principale viene attivata, funzionerà con tutti i programmi e l'icona **MV** rimarrà sempre visualizzata sullo schermo.

Spegnimento programmabile (fino a 99 giorni)

Questa funzione consente di interrompere tutti i cicli di irrigazione programmati per un determinato periodo di tempo, da 1 a 99 giorni. Alla fine del periodo di disattivazione della programmazione, il programmatore riprende il normale funzionamento.

1. Dalla modalità di inattività, premere il pulsante finché non viene visualizzata l'icona . Attendere due secondi fino a che sullo schermo compare **Off**. Il programmatore è ora in modalità System Off.
2. Premere il pulsante : verrà visualizzato un "1" lampeggiante, che indica il numero di giorni in cui il programmatore resterà spento. Programmare i giorni di disattivazione come desiderato, fino a un massimo di 99 giorni.
3. Il display mostrerà il numero di giorni rimanenti nel periodo OFF.
4. Per interrompere il periodo di spegnimento, premere il pulsante per tornare alla schermata della modalità di inattività, che mostra l'ora del giorno e il giorno della settimana.

INDICATORE DURATA BATTERIA

La capacità rimanente della batteria può essere stimata dall'indicatore durata batteria mostrato sul display. NODE può funzionare con una o due batterie a 9 V. L'utilizzo di due batterie a 9 V raddoppierà quasi la durata della batteria rispetto all'utilizzo di una sola batteria a 9 V. Il grafico dell'indicatore durata batteria sotto mostra una stima della durata della batteria rimanente.

 Completa: durata rimanente della batteria 100-60%

 Media: durata rimanente della batteria 60-25%







 Bassa: durata rimanente della batteria 25-0%

 Sostituire immediatamente la batteria.

RESETTAGGIO DEL PROGRAMMATORE

IT

Resettando il programmatore si cancelleranno i dati e si riavvia il programmatore stesso. Un reset non cancella comunque un programma salvato nella memoria permanente Easy Retrieve (vedere pagina 12).

1. Dalla modalità di inattività, tenere premuti i tasti ,  e .
2. Dopo due secondi lo schermo si spegnerà. Continuare a tenere premuti i tasti ,  e .
3. Sullo schermo lampeggerà 12:00. Rilasciare i pulsanti.
4. Il programmatore potrebbe mostrare un conteggio alla rovescia da 10 a 1 sul display, e quindi 12:00 AM lampeggiante al completamento del reset. Il programmatore può essere ora riprogrammato.

Problema	Cause	Soluzioni
Sullo schermo non compare nulla.	Lo schermo è spento. La batteria è scarica.	Premere qualsiasi pulsante per un secondo.
Lo schermo indica irrigazione ma non succede nulla.	Assenza di pressione idraulica. Solenoido guasto. Solenoido incompatibile.	Controllare che l'acqua sia aperta. Sostituire il solenoide. È necessario utilizzare un solenoide bistabile a c.c. Hunter (P/N 458200) o altro solenoide bistabile cc compatibile.
L'irrigazione automatica non si avvia all'orario previsto.	Il programmatore è in modalità System Off. Parametro AM/PM dell'orario della centralina non impostato correttamente. Parametro AM/PM della partenza non impostato correttamente.	Verificare che il programmatore sia programmato per l'irrigazione automatica. Correggere AM/PM dell'orario della centralina. Correggere AM/PM dell'orario della partenza.
Il sensore pioggia non sospende l'irrigazione.	Sensore pioggia difettoso o collegato in modo errato.	Verificare il corretto funzionamento del sensore pioggia e i cablaggi (vedere pagina 10).
Il programmatore effettua l'irrigazione più di una volta.	Al programma sono assegnati più orari di avvio. Per ogni programma è possibile impostare fino a quattro orari di avvio.	Eliminare le partenze secondo necessità.

SPECIFICHE

IT

Dimensioni: 3 ½"(89 mm) diametro, 2 ½"(64 mm) altezza

Ingressi sensori: uno

Fonte di alimentazione: una batteria a 9 V (usarne due per aumentare la durata). Attiva solenoidi cc bistabili funzionanti a 9-11Vcc (Hunter PN 458200)

Temperatura di funzionamento: da 0°F a 140°F oppure da -17°C a 60°C

Certificazioni:

IP68

CE

FCC

C-Tick

NODE AUSSTATTUNGSMERKMALE	2
NODE KOMPONENTEN	3
Bedientasten	
LCD-Anzeige	
ANSCHLIESSEN DER BATTERIE/BATTERIEN	4
ANBRINGEN DER MAGNETSPULEN	5
So verkabeln Sie Gleichstrom-Magnetspulen mit dem NODE	
So montieren Sie den NODE auf ein Ventil (Abbildung 1)	
MONTAGE DES NODE	6
ANSCHLIESSEN EINES WETTERSENSORS	6
Datum und Uhrzeit einstellen	
ENERGIESPARMODUS	7
BETRIEBSMODUS	7
PROGRAMMIERUNG	7
Bewässerungszeiten einstellen	
Laufzeiten einstellen	
Bewässerungstage einstellen	
Ungerade/gerade Bewässerungstage auswählen	
Tagesintervalle für die Bewässerung auswählen	
Saisonale Anpassung einstellen	
Ausschalten des Systems	
Manuelle Bewässerung	
Sensorbetrieb	
ERWEITERTE PROGRAMMIERFUNKTIONEN	12
Sensorüberbrückung	
Permanentspeicher	
Einrichten des Hauptventilbetriebs	
(nur für NODE-200, NODE-400 und NODE-600)	
Programmierbar Aus (bis zu 99 Tagen)	
Hunter Quick Check	

BATTERIESTANDANZEIGE	14
STEUERGERÄT ZURÜCKSETZEN	14
FEHLERSUCHE	15
TECHNISCHE DATEN	16
NOTIZEN	17



- Einfache Drucktasten-Programmierung
- Einzelstationenmodell (NODE-100) mit DC Impulsspule. Modelle mit ein, zwei, vier oder sechs Stationen sind ebenfalls verfügbar (Spulen nicht im Lieferumfang enthalten).
- Großes Flüssigkristall-Display (LCD) mit leicht verständlichen Symbolen
- Betrieb über mindestens eine herkömmliche 9-Volt Alkalibatterie (verwenden Sie zwei für eine erweiterte Batterielebensdauer)
- Drei Programme (A, B oder C) mit jeweils bis zu vier Startzeiten
- Laufzeiten von einer Minute bis zu sechs Stunden
- Manuelle Berechnungsoptionen
- Batteriestandanzeige
- Kompatibel mit einem verkabelten Regensensor
- Permanentspeicher speichert alle Angaben des Programms
- Saisonale Anpassung von 10 - 150 %
- Der Easy Retrieve™-Speicher ermöglicht das Speichern/Abrufen bevorzugter Programmdateien
- Manueller Bypass des Regensensors
- Die Gesamtlaufzeitberechnung zeigt die Gesamtbewässerungszeit pro Programm

Dieser Abschnitt bietet Ihnen eine Übersicht einiger NODE-Komponenten. Die detaillierte Erklärung jedes Elements folgt an späterer Stelle. Dieser Abschnitt kann jedoch hilfreich sein, um sich mit den unterschiedlichen Optionen vertraut zu machen.

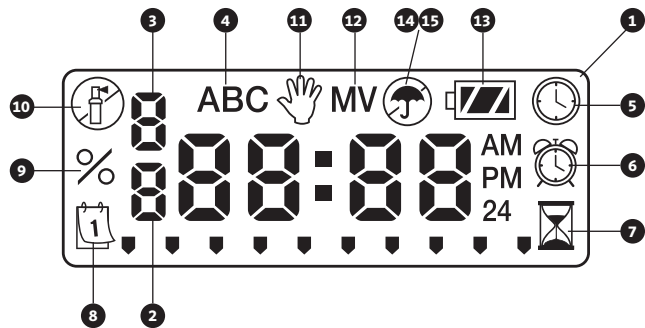

Bedientasten

1. **Taste:** Erhöht die markierte, blinkende Anzeige
2. **Taste:** Verringert die markierte, blinkende Anzeige
3. **Taste:** Wählt die Programmierfunktion
4. **Taste:** Rückt die markierte, blinkende Anzeige zum nächsten Element vor
5. **Taste:** Rückt die markierte, blinkende Anzeige zum vorherigen Element zurück
6. **PRG Taste:** Wählt das Programm (A, B oder C)

LCD-Anzeige

1. **Hauptanzeige:** Zeigt alle Angaben zum Programm an
2. **Stationsnummer:** Zeigt an, welche Stationsnummer programmiert wird
3. **Startzeitnummer:** Zeigt an, welche Startzeitnummer programmiert wird
4. **Programm:** Wählt das Programm (A, B oder C)
5. **Aktuelle Tageszeit:** Gibt an, dass der aktuelle Tag und Uhrzeit eingestellt sind
6. **Startzeiten:** Gibt die eingestellten Startzeiten an
7. **Laufzeiten:** Gibt die eingestellten Laufzeiten an. Laufzeiten können durch den Benutzer von einer Minute bis zu sechs Stunden eingestellt werden.
8. **Bewässerungstage:** Der Anwender kann individuelle Bewässerungstage bestimmen, oder eine bestimmte Anzahl an Tagen (Intervalle) zwischen Bewässerungen einstellen
9. **% Saisonale Anpassung:** Die saisonale Anpassung kann von 10 - 150 % programmiert werden (Werkseinstellung ist 100 %)
10. **System Aus:** Zeigt an, dass die Bewässerung ausgesetzt ist
11. **Manuell an/aus:** Zeigt manuelle Bewässerungsprogrammierung an. Der Anwender kann die Station manuell aktivieren.
12. **MV -** Zeigt an, dass Station 1 auf Hauptventilbetrieb eingestellt ist (nur verfügbar bei Modellen mit zwei, vier oder sechs Stationen)
13. **Batteriestatus:** Zeigt den Ladezustand der Batterie an
14. **Regenschirm:** Zeigt an, dass der Regensensor die Bewässerung aussetzt
15. **Durchgestrichener Regenschirm:** Zeigt an, dass der Regensensor manuell umgangen wurde

ANSCHLIESSEN DER BATTERIE/BATTERIEN

DE

Das NODE verwendet ein oder zwei herkömmliche 9-Volt Alkalibatterien (nicht im Lieferumfang enthalten), um die Ventile zu betreiben und das Steuergerät zu programmieren. Das Steuergerät kann entweder mit einer oder auch mit zwei herkömmlichen 9-Volt Alkalibatterien betrieben werden. Unter normalen Bedingungen hält eine einzelne Batterie ca. 1 Jahr und 2 Jahre, wenn zwei 9-Volt Alkalibatterien verwendet werden.



HINWEIS: Der NODE verfügt über einen Permanentspeicher. Dadurch kann die Batterie entfernt werden, ohne Programminformationen zu verlieren.

So installieren Sie die Batterie/Batterien

1. Schrauben Sie die Rückseite des NODE ab, um Zugriff auf das Batteriefach zu erhalten.
2. Legen Sie die Batterie/Batterien in den Batteriehälter ein und schließen Sie das Steuergerät mit dem Batteriestecker an.
3. Achten Sie darauf, dass sich im Batteriefach kein Wasser befindet.
4. Schrauben Sie die Rückseite des NODE wieder auf die Vorderseite.



HINWEIS: Achten Sie darauf, dass die Dichtungsmarkierungen auf der hinteren Hälfte des NODE bündig mit der vorderen Hälfte abschließen, um eine einwandfreie Dichtung zu erzielen.

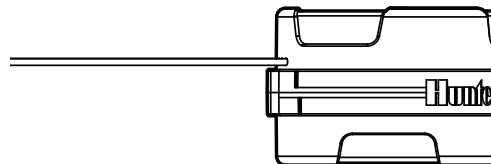
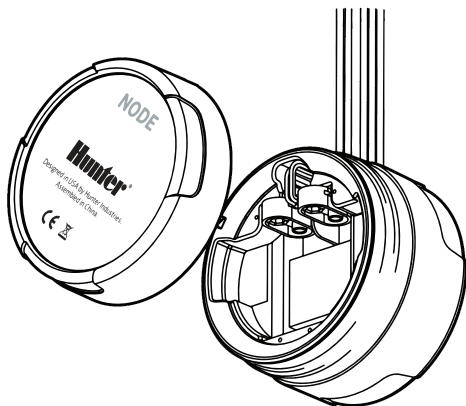

ANBRINGEN DER MAGNETSPULEN

DE

Das NODE-100 wird mit einer Spule geliefert, die am Steuergerät befestigt ist. Bei dem NODE-100-LS ist keine Spule im Lieferumfang enthalten. Die NODE-200, NODE-400 und NODE-600 Steuergeräte für mehrere Stationen betreiben jeweils bis zu zwei, vier oder sechs Spulen. Die Hunter DC Impulsspulen (P/N 458200) können ganz einfach an allen Hunter Kunststoffventilen montiert werden.



HINWEIS: Betrieb nur über DC Impulsspulen 9-11 VDC. 24 VAC Magnetspulen eignen sich nicht für den Betrieb des NODE.

So verkabeln Sie Gleichstrom-Magnetspulen mit dem NODE

1. Verbinden Sie die schwarze Ader einer jeden Magnetspulen mit dem gemeinsamen Masseleiter (schwarze Ader) des NODE. Sichern Sie alle Masseleiter mit wasserdichten Steckverbindern.
2. Verbinden Sie eine rote Ader einer jeden Magnetspule mit der entsprechenden Stationsader (rote Ader) des NODE. Die Stationsnummern sind auf der Oberfläche des NODE markiert. Sichern Sie alle Kabelverbindungen mit wasserdichten Steckverbindern.



HINWEIS: Der maximale Drahtabstand zwischen der Spule und dem NODE beträgt 30 m (100') bei einem Drahtdurchmesser von mindestens 18 AWG (1 mm).

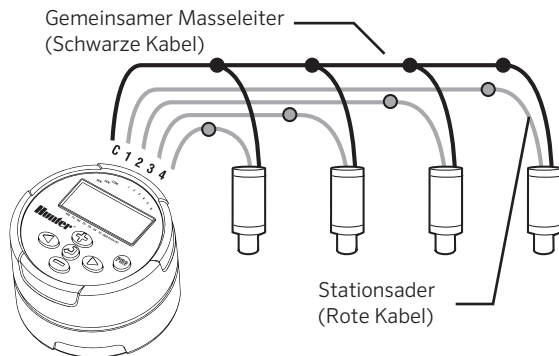

MONTAGE DES NODE

Der NODE kann leicht an jedem beliebigen Hunter Kunststoffventil angebracht werden. Mit der speziell entworfenen Montageklammer ist die Installation eine Leichtigkeit. Eine Schutzabdeckung aus Gummi verhindert Schmutzansammlungen auf der Oberfläche des NODE.

So montieren Sie den NODE auf ein Ventil (Abbildung 1)

1. Befestigen Sie eine Hunter DC Impulsspule (P/N 458200) in der Ventilhaube.
2. Setzen Sie das kleine offene Ende des NODE-Halters oben auf die Spule.
3. Setzen Sie das NODE-Steuerg r t in das gro e offene Ende des NODE-Halters.





Abbildung 1

ANSCHLIESSEN EINES WETTERSENSORS

Das NODE kann auch mit einem Hunter Mini-Clik® oder Wired Rain-Clik® Regensensor verbunden werden. Ein solcher Sensor dient dazu, die Bew sserung einzustellen, wenn es die Wetterbedingungen erfordern.

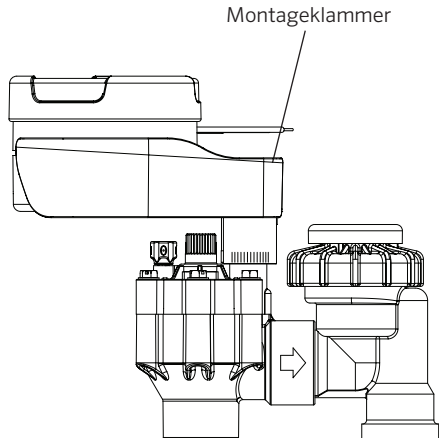

HINWEIS: Wenn der verkabelte Regensensor die Beregnung unterbricht, wird im Display das Symbol , „AUS“ und  angezeigt.

1. Schneiden Sie die am NODE befestigte gelbe Aderschlaufe ungef hr in der Mitte der Schlaufe durch.
2. Entfernen Sie ungef hr 13 mm der Isolierung von jeder Ader. Sie k nnen den Regensensor bis zu 30 m (100 ft) vom NODE-Steuerg r t entfernt montieren (Drahtdurchmesser von mindestens 18 AWG/1 mm).
3. Sichern Sie die Kabelverbindungen mit wasserdichten Steckverbindern.

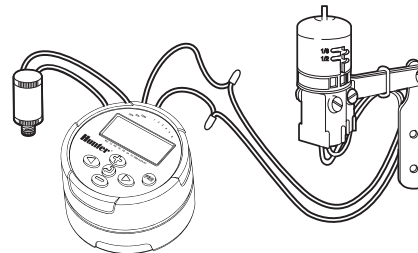

Hunter Modell Mini-Clik®

ENERGIESPARMODUS

Normalerweise zeigt das NODE-Display Datum und Uhrzeit, Wochentag, MV (wenn die Hauptventil-Option aktiviert ist) und die Batteriestandanzeige an. Nach kurzer Inaktivität schaltet sich das Display aus, um die Batterie zu schonen. Drücken Sie auf eine beliebige Taste, um den Leerlaufmodus zu beenden.

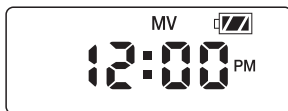

BETRIEBSMODUS

Wenn das Steuergerät ein Programm ausführt, zeigen die Symbole auf dem Display die Stationsnummer, den Programmbuchstaben, die verbleibende Laufzeit und das blinkende Getrieberegnersymbol an.



PROGRAMMIERUNG

DE

Das NODE verwendet die herkömmliche Programmierung für Hunter Steuergeräte mit drei Programmen (A, B oder C) und vier Startzeiten pro Programm. Bei den Standard Hunter Steuergeräten wird ein Drehschalter verwendet, um zwischen den Programmierfunktionen umzuschalten. Bei dem NODE wird diese Taste (↻) allerdings verwendet, um schnell und einfach das Berechnungsprogramm zu erstellen. Ändern Sie bei der Programmierung den blinkenden Teil der Anzeige mit den (⏪) oder (⏩) Tasten. Um nicht blinkende Elemente zu ändern, drücken Sie die Tasten (⏪) oder (⏩), bis das gewünschte Element anfängt zu blinken.



Datum und Uhrzeit einstellen

1. Drücken Sie die Taste (↻) solange, bis das (🕒)-Symbol angezeigt wird.
2. Alle vier Ziffern werden angezeigt, die das Jahr darstellen. Ändern Sie das Jahr anhand der Tasten (⏪) oder (⏩). Drücken Sie die Taste (⏩), um zur Monatseinstellung zu gelangen.
3. Alle vier Ziffern werden angezeigt, von denen die zwei Ziffern links den blinkenden Monat darstellen. Ändern Sie den Monat anhand der Tasten (⏪) oder (⏩). Drücken Sie die Taste (⏩), um zur Tageseinstellung zu gelangen.
4. Es werden nur die beiden Ziffern rechts blinkend angezeigt. Sie repräsentieren den Tag. Ändern Sie mit den Tasten (⏪) oder (⏩) den Tag. Drücken Sie die Taste (⏩), um zur Stundeneinstellung zu gelangen. Drücken Sie die Taste (⏩), um zur Uhrzeiteinstellung zu gelangen.
5. Die AM/PM/24-Stunden Einstellung wird blinkend dargestellt. Drücken Sie die (⏪)- oder (⏩)-Taste, um die Zeiteinstellung von AM auf PM oder auf 24 Stunden zu ändern. Drücken Sie die Taste (⏩), um die Stunden einzustellen.

- Alle vier Nummern werden mit den zwei blinkenden Nummern links dargestellt, die die Stunde anzeigen. Ändern Sie die Stunde anhand der Tasten oder . Drücken Sie die Taste , um die Minuten einzustellen.
- Alle vier Nummern werden mit den zwei blinkenden Nummern rechts dargestellt, die die Minuten anzeigen. Ändern Sie die Minuten anhand der Tasten oder . Drücken Sie auf die Taste, um in Schritt 2 zur Einstellung für das Jahr zu gelangen.
- Drücken Sie die Taste , um zur nächsten Programmierfunktion zu gelangen oder lassen Sie das Steuergerät wieder in den Energiesparmodus zurückkehren.



Bewässerungszeiten einstellen

- Drücken Sie die Taste solange, bis das -Symbol angezeigt wird.
- Die Startzeit wird zusammen mit dem Programmbuchstaben (A, B oder C) und der Startzeitnummer (1, 2, 3 oder 4) oben links in der Anzeige blinkend dargestellt. In jedem Programm können bis zu vier verschiedene Startzeiten eingerichtet werden.
- Mit den Tasten oder können Sie die Startzeit des angezeigten Programms ändern. Jedes Drücken dieser Taste ändert die Startzeit in 1-Minuten-Schritten.
- Drücken Sie die Taste , um dem angezeigten Programm eine zusätzliche Startzeit hinzuzufügen. Die Startzeitnummer wird oben links im Display dargestellt.
- Drücken Sie die Taste , um einem anderen Programm Startzeiten hinzuzufügen.

- Drücken Sie die Taste , um zur nächsten Programmierfunktion zu gelangen oder lassen Sie das Steuergerät wieder in den Energiesparmodus zurückkehren.











HINWEIS: Nachdem Sie die Laufzeit für die letzte Station programmiert haben, drücken Sie die Taste , um die Gesamtlaufzeit für das Programm anzuzeigen.

Laufzeiten einstellen

- Drücken Sie die Taste solange, bis das -Symbol angezeigt wird.
- Die Laufzeit wird blinkend angezeigt. Ebenfalls angezeigt wird der Programmbuchstabe (A, B oder C) und die aktive Stationsnummer unten links im Display. Drücken Sie die oder Tasten, um die Stationslaufzeit für eine Dauer zwischen einer Minute und sechs Stunden zu ändern.
- Drücken Sie die Taste , um zur nächsten Station zu gelangen.
- Drücken Sie die Taste , um einem anderen Programm eine Startzeit hinzuzufügen.
- Drücken Sie die Taste , um zur nächsten Programmierfunktion zu gelangen oder lassen Sie das Steuergerät wieder in den Energiesparmodus zurückkehren.





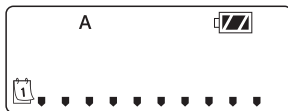

Bewässerungstage einstellen

1. Drücken Sie die Taste  solange, bis das -Symbol angezeigt wird.
2. Der Programmbuchstabe (A, B oder C) wird angezeigt.
3. Die Pfeile zeigen auf die Wochentage, an denen eine Beregnung ausgeführt wird. Drücken Sie die Tasten  oder , um durch die Tage zu blättern.
4. Drücken Sie die Taste , um diesen Tag für das angezeigte Programm zu aktivieren oder die Taste , um die Bewässerung an diesem Tag zu deaktivieren. **Der Pfeil weist auf die Bewässerungstage des aktiven Programms.**
5. Falls gewünscht, drücken Sie die Taste , um Bewässerungstage für ein anderes Programm zu bestimmen.
6. Drücken Sie die Taste , um zur nächsten Programmierfunktion zu gelangen oder lassen Sie das Steuergerät wieder in den Energiesparmodus zurückkehren.



Ungerade/gerade Bewässerungstage auswählen





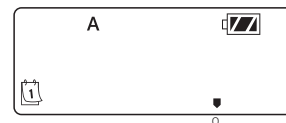

Bei dieser Funktion werden die Kalendertage des Monats für die Bewässerung zugrunde gelegt und nicht bestimmte Wochentage.

1. Drücken Sie die Taste  solange, bis das -Symbol angezeigt wird.
2. Drücken Sie die Taste , bis sich der Cursor auf der Anzeige entweder über UNGERADE oder über GERADE befindet.
3. Drücken Sie zur Auswahl die Taste  oder die Taste , um die Bewässerung entweder an UNGERADEN, oder GERADEN Tagen zu deaktivieren.

4. Sobald der Modus UNGERADE oder GERADE aktiviert ist, ist dies der einzige auf der Anzeige dargestellte Cursor.





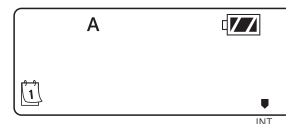

Tagesintervalle für die Bewässerung auswählen

1. Drücken Sie die Taste  solange, bis das -Symbol angezeigt wird.
2. Drücken Sie die Taste , bis sich der Cursor auf der Anzeige über **INT** befindet.
3. Drücken Sie die Taste . Eine 1 beginnt als Hinweis auf die Anzahl der Tage zwischen den Bewässerungen zu blinken.
4. Drücken Sie die  oder  Tasten, um die Anzahl der Tage zwischen den Beregnungstagen auszuwählen (von 1 bis zu 31 Tagen).



Saisonale Anpassung einstellen

1. Drücken Sie die Taste  solange, bis das -Symbol angezeigt wird.
2. Drücken Sie die Tasten  oder , um den voreingestellten Wert von 100 % für die saisonale Anpassung zu erhöhen oder zu senken (Tiefstwert 10 %, Höchstwert 150 %).

3. Der für die saisonale Anpassung programmierte Wert wird allen Bewässerungsprogrammen zugewiesen und umgehend in den angezeigten Laufzeiten reflektiert. Wenn beispielsweise Laufzeiten von 20 Minuten programmiert werden und dann die saisonale Anpassung von 100 % auf 50 % geändert wird, werden die angezeigten Laufzeiten auf 10 Minuten reduziert.



Ausschalten des Systems

Um Ihr Steuergerät abzuschalten, drücken Sie die Taste solange, bis das Symbol und **Off** (Aus) auf dem Display angezeigt werden. Um das Steuergerät wieder in den automatischen Programmiermodus zu versetzen, drücken Sie die Taste . Das Steuergerät kehrt umgehend in den automatischen Programmiermodus zurück und wird die Zeit und die Batteriestandanzeige anzeigen.



Manuelle Bewässerung

Die manuelle Bewässerung erlaubt dem Anwender jede Station, oder ein Programm für eine spezifische Laufzeit zu testen. Die Schaltstellung eines Wettersensors (falls verwendet) wird in diesem Modus ignoriert.

1. Vergewissern Sie sich, dass sich das Steuergerät im Energiesparmodus befindet. Halten Sie die Taste solange gedrückt, bis das -Symbol angezeigt wird.

2. Die Stationsnummer wird in der Anzeige unten links zusammen mit der Laufzeit angezeigt.
3. Wählen Sie mit den Tasten und die gewünschte Station, und bestimmen Sie für sie mit den Tasten und die manuelle Bewässerungsdauer.
4. Um ein Programm manuell zu aktivieren, drücken Sie die Taste . Der Programmbuchstabe (A, B oder C) wird auf dem Display angezeigt. Wenn ein anderes Programm benötigt wird, drücken Sie die Taste , bis es auf der Anzeige erscheint.
5. Um den manuellen Bewässerungszyklus zu beenden, drücken Sie die Taste solange, bis die Zeitanzeige auf Null steht.
6. Drücken Sie die Taste , um zur nächsten Programmierfunktion zu gelangen oder lassen Sie das Steuergerät wieder in den Energiesparmodus zurückkehren.



HINWEIS:

- Indem Sie die oder Tasten drücken während eine Station im manuellen Beregnungsmodus ausgeführt wird, ändern Sie die Beregnungszeit dieser Station.
- Während eine Station im manuellen Bewässerungsmodus operiert, wird die Bewässerung durch die aktuelle Station durch Drücken der Taste beendet und die nächste Station angesteuert.
- Während eine Station im manuellen Bewässerungsmodus operiert, wird die Bewässerung durch die aktuelle Station durch Drücken der Taste beendet und die vorherige Station erneut angesteuert.

Sensorbetrieb

Das NODE ist mit den Hunter Klik Regensensoren kompatibel, inklusive dem Mini-Klik®, Freeze-Klik und dem Wired Rain-Click® sowie vielen weiteren Unterbrechungsgeräten/-sensoren, die keinen Stromanschluss benötigen. Verbinden Sie den Sensor einfach mit dem NODE-Steuergerät, indem Sie die gelbe Aderschleife durchschneiden und die Enden mit den Sensoradern verbinden.



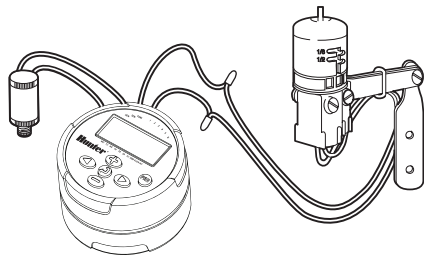

HINWEIS: NODE ist nicht kompatibel mit dem Hunter Wireless Rain-Click®, oder anderen Wettergeräten, die eine 24 VAC Stromversorgung erfordern.

Wenn der Sensor aktiviert ist, setzt die Bewässerung aus und auf der Anzeige erscheint das Symbol ☂.





Alle erweiterten Programmfunktionen werden aus dem Leerlaufmodus ausgelöst, in dem Zeit, Wochentag und Batteriestandanzeige auf dem Display angezeigt werden. Wenn ein Element im Display blinkt bedeutet dies, dass sich das Steuergerät in einem der Programmiermodi befindet. Nach kurzer Inaktivität wechselt das Steuergerät in den Leerlaufmodus.



Sensorüberbrückung

1. Drücken und halten Sie im Leerlaufmodus die  Taste, bis das  Symbol angezeigt wird.
2. Auf der Anzeige erscheinen ein blinkendes Regenschirm-Symbol und **On** (Ein).



3. Drücken Sie die Taste , um den Sensor zu umgehen. Auf dem Display wird  und AUS angezeigt. Dies bedeutet, dass der Wettersensor umgangen wurde. Während des Normalbetriebs wird das Symbol  als Hinweis darauf angezeigt, dass sich das Steuergerät im Überbrückungsmodus befindet.





4. Um den Wettersensor zu reaktivieren, halten Sie die Taste  solange gedrückt, bis das -Symbol angezeigt wird. Drücken Sie dann die Taste , um zum normalen Sensormodus zurückzukehren.

Permanentspeicher



Mit dieser Funktion kann der Benutzer ein bevorzugtes Programm im Permanentspeicher des Steuergeräts speichern, das jederzeit wiederhergestellt werden kann. Auf diese Weise können vorgenommene Änderungen überschrieben und in den Originalzustand des Programmierplans zurückversetzt werden.

So speichern Sie ein Programm:

1. Stellen Sie sicher, dass das Steuergerät mit dem bevorzugten Programmierplan programmiert wurde.
2. Drücken und halten Sie aus dem Leerlaufmodus heraus fünf Sekunden lang die  und  Taste, um das aktuelle Programm zu speichern.
3. Der Bildschirm zeigt drei gestrichelte Linien an, die von links nach rechts verlaufen. Dies bedeutet, dass das aktuelle Programm im Permanentspeicher gesichert wird. Nach Abschluss des Vorgangs blinkt **Done** (Fertig) in der Anzeige.



So rufen Sie ein gespeichertes Programm auf:

1. Drücken und halten Sie aus dem Leerlaufmodus heraus fünf Sekunden lang die  und  Taste.
2. Der Bildschirm zeigt drei gestrichelte Linien an, die von links nach rechts verlaufen. Dies bedeutet, dass das aktuelle Programm vom Permanentspeicher abgerufen wird.

Das Steuergerät verwendet nun als aktuelles Programm das bevorzugte Programm. Nach Abschluss des Vorgangs blinkt **Done** in der Anzeige.



HINWEIS: Lassen Sie bei der Verwendung des Permanentspeichers Vorsicht walten. Beim Speichern von Programmdateien in den Permanentspeicher werden die aktuellen Programmdateien verwendet und alle im Permanentspeicher gespeicherten Daten überschrieben. Wenn Sie Programmdateien speichern, vergewissern Sie sich, dass Sie die aktuellen Programmdateien wirklich speichern wollen.

Einrichten des Hauptventilbetriebs (nur für NODE-200, NODE-400 und NODE-600)

Die NODE Modelle mit mehreren Stationen (NODE-200, NODE-400 und NODE-600) können mit einem normalerweise geschlossenen Hauptventil programmiert werden. Bei der Programmierung mit dem Hauptventil, bestimmen Sie Station 1 als Hauptventil, wodurch ihr die Aktivierungsfunktion einer Bewässerungsstation effektiv genommen wird.

1. Drücken Sie im Leerlaufmodus die Taste, bis das -Symbol angezeigt wird.
2. Programm A wird zusammen mit der aktiven Stationsnummer unten links angezeigt. Achten Sie darauf, dass die aktiv angezeigte Station „1“ ist.



3. Drücken Sie einmal die Taste . Das **MV**-Symbol erscheint im Display und die Zeitanzeige erlischt. Station 1 agiert nun als das Hauptventil und kann in anderen Programmieranzeigen nicht verwendet werden.

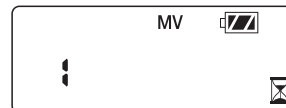

4. Wenn das Hauptventil aktiviert ist, wird es allen Programmen zugewiesen, und das **MV**-Symbol wird jederzeit auf dem Bildschirm angezeigt.





Programmierbar Aus (bis zu 99 Tagen)

Mit dieser Funktion kann der Anwender alle Bewässerungsprogramme für einen angegebenen Zeitraum von 1 bis 99 Tagen stoppen. Nach Ablauf der programmierten Auszeit schaltet das Steuergerät wieder in den regulären Betrieb um.

1. Drücken Sie im Leerlaufmodus die Taste, bis das -Symbol angezeigt wird. Das Steuergerät befindet sich nun im System-Aus-Modus.
2. Drücken Sie die Taste und eine blinkende „1“ wird angezeigt. Diese steht für die Anzahl an Tagen, die das Steuergerät ausgeschaltet bleibt. Programmieren Sie die gewünschten Aus-Tage, maximal 99 Tage.
3. Die Anzeige zeigt die Anzahl der in der Aus-Periode verbleibenden Tage.
4. Um den AUS-Zeitraum zu unterbrechen, klicken Sie auf die Taste. So kehren Sie zum Leerlaufmodus-Bildschirm zurück und Uhrzeit und Wochentag werden angezeigt.

BATTERIESTANDANZEIGE







Die Batteriestandanzeige zeigt auf dem Display an, wie viel Lebensdauer Ihre Batterie noch hat. Das NODE kann entweder mit einer oder auch mit zwei herkömmlichen 9-Volt Alkalibatterien betrieben werden. Indem Sie zwei 9-Volt Alkalibatterien verwenden, wird die Lebensdauer einer einzelnen 9-Volt Alkalibatterie verdoppelt. In der nachfolgenden Tabelle zur Batteriestandanzeige wird Ihnen die geschätzte Lebensdauer der Batterie angezeigt.

-  Voll: 100 – 60 % verbleibende Batteriebensdauer
-  Mittel: 60 – 25 % verbleibende Batteriebensdauer
-  Niedrig: 25 – 0 % verbleibende Batteriebensdauer
-  Ersetzen Sie umgehend die Batterie!

STEUERGERÄT ZURÜCKSETZEN

DE

Durch ein Zurücksetzen des Steuergerätes werden die aktuellen Programmdateien gelöscht und das Steuergerät neu gestartet. Ein in den permanenten Speicher gespeichertes Programm (siehe Seite 12 zum Speichern eines bevorzugten Programms) wird durch ein Zurücksetzen jedoch nicht gelöscht.

1. Drücken und halten Sie im Leerlaufmodus die , , und  Tasten.
2. Nach zwei Sekunden wird der Bildschirm leer. Halten Sie die Tasten ,  und  weiterhin gedrückt.
3. Auf der Anzeige blinkt 12:00. Lassen Sie die Tasten los.
4. Die Anzeige des Steuergerätes zeigt einen Countdown von 10 bis 1 an. Nach abgeschlossenem Reset blinkt dann 12:00 AM. Nun kann das Steuergerät neu programmiert werden.

Problem	Ursachen	Lösungen
Keine Anzeige	Anzeige ist ausgeschaltet. Batterie ist leer.	Drücken Sie 1 Sekunde lang eine beliebige Taste. Ersetzen Sie die Batterie.
Die Anzeige zeigt Bewässerung an, obwohl keine stattfindet.	Kein Wasserdruck. Defekte Magnetspule. Nicht kompatible Magnetspule.	Schalten Sie die Hauptsystemversorgung ein. Ersetzen Sie die Magnetspule. Es müssen Hunter DC Impulsspulen für Batteriebetrieb (T/N 458200) oder vergleichbare, kompatible Gleichstrom-Impulsmagnetspulen verwendet werden.
Die automatische Bewässerung beginnt nicht zur Startzeit.	Steuergerät im System-Aus-Modus. Uhrzeit nicht korrekt eingestellt. Uhrzeit für die Startzeit nicht korrekt eingestellt.	Überprüfen Sie, ob das Steuergerät für automatische Bewässerung programmiert ist. Stellen Sie die korrekte Uhrzeit ein. Stellen Sie die korrekte Uhrzeit für die Startzeit ein.
Regensensor setzt die Bewässerung nicht aus.	Regensensor ist defekt oder falsch verkabelt.	Überprüfen Sie den ordnungsgemäßen Betrieb des Regensensors und der Kabelverbindungen (siehe Seite 10).
Das Steuergerät bewässert mehr als einmal.	Dem Programm wurde mehr als eine Startzeit zugewiesen. Jedes Programm hat bis zu vier Startzeiten.	Löschen Sie nicht benötigte Startzeiten aus dem Programm.

TECHNISCHE DATEN

DE

Abmessungen: Durchmesser 89 mm, Höhe 64 mm

Sensoreingänge: Einer

Stromquelle: Eine 9-Volt Alkalibatterie (verwenden Sie zwei für eine
erweiterte Batterielebensdauer).

Betriebstemperatur: -17 °C bis 60 °C oder 0 °F bis 140 °F

Zulassungen:

IP68

CE

FCC

C-Tick

CARACTERÍSTICAS DO NODE	2
COMPONENTES DO NODE	3
Botões de controle	
Visor LCD	
CONEXÃO DA(S) BATERIA(S)	4
CONEXÃO DOS SOLENOIDES	5
Como conectar solenoides CC ao NODE	
Como instalar o NODE em uma válvula (Figura 1)	
INSTALAÇÃO DO NODE	6
CONEXÃO DE UM SENSOR METEOROLÓGICO	6
Ajuste de data e hora	
MODO INATIVO	7
MODO DE REGA	7
PROGRAMAÇÃO	7
Ajuste dos horários de início de rega	
Ajuste dos tempos de rega	
Ajuste dos dias de rega	
Seleção de rega em dias pares/ímpares	
Seleção de rega em intervalos de dias	
Definição do ajuste sazonal	
Desligamento do sistema	
Rega manual	
Funcionamento do sensor	
RECURSOS DE PROGRAMAÇÃO AVANÇADOS	12
Supressão do sensor	
Memória Easy Retrieve	
Ajuste do funcionamento da válvula mestre (somente para NODE-200, NODE-400 e NODE-600)	
Interrupção programável (até 99 dias)	
Teste Quick Check da Hunter	

INDICADOR DO NÍVEL DAS BATERIAS	14
REDEFINIÇÃO DO CONTROLADOR	14
GUIA DE RESOLUÇÃO DE PROBLEMAS	15
ESPECIFICAÇÕES	16
NOTAS	17

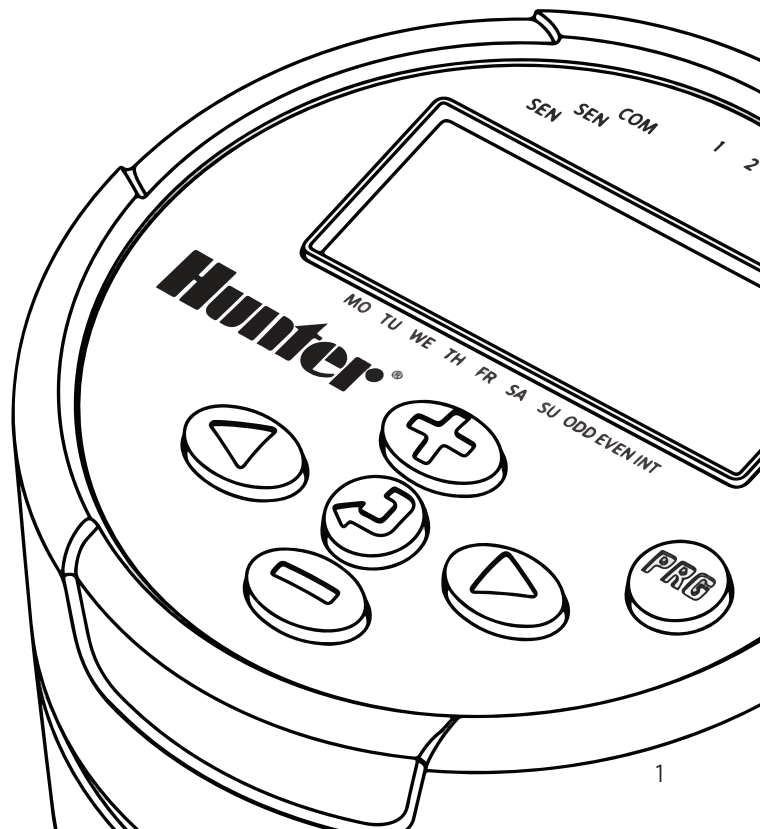

- Programação simples por meio de botões
- Modelo de setor único (NODE-100) com solenoide latching CC. Também estão disponíveis modelos de um, dois, quatro ou seis setores (solenoídes não incluídos).
- Visor amplo de cristal líquido (LCD) com ícones fáceis de entender
- Funciona com pelo menos uma bateria alcalina comum de 9 V (utilize duas para aumentar a duração)
- Três programas (A, B ou C) com até quatro horários de início em cada um
- Tempos de rega de um minuto a seis horas
- Recursos de rega manual
- Indicador de nível das baterias
- Compatível com sensor de chuva com fio
- Memória não volátil que mantém todas as informações de programação
- Ajuste sazonal de 10 a 150%
- Memória Easy Retrieve™, que permite salvar e recuperar os dados do programa preferido
- Supressão manual do sensor de chuva
- Calculadora do tempo total de rega, que mostra o tempo total de rega por programa

COMPONENTES DO NODE

PT

Esta seção oferece uma visão geral dos componentes do NODE. Cada item será discutido em detalhes mais adiante. No entanto, esta seção pode ajudar você a se familiarizar com as diferentes opções disponíveis.

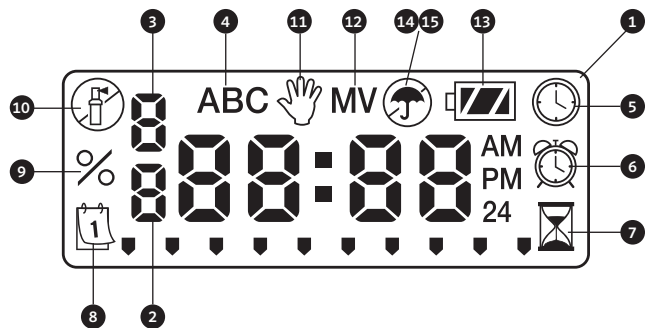

Botões de controle

1. – Aumenta o item selecionado que está piscando.
2. – Diminui o item selecionado que está piscando.
3. – Seleciona uma função de programação.
4. – Muda o item selecionado para o item seguinte.
5. – Muda o item selecionado para o item anterior.
6. – Seleciona o programa (A, B ou C).

Visor LCD

1. **Tela principal:** indica todas as informações do programa.
2. **Número do setor:** indica o número do setor que está sendo programado.
3. **Número do horário de início:** indica o número do horário de início que está sendo programado.
4. **Programa:** indica o programa (A, B ou C).
5. **Hora e dia atuais:** aparece quando a hora/dia atuais são ajustados.
6. **Horários de início:** aparece quando os horários de início são ajustados.
7. **Tempos de rega:** aparece quando os tempos de rega são ajustados. Permite ajustar os tempos de rega de um minuto a seis horas.
8. **Dias de rega:** permite selecionar dias específicos para a rega ou definir um número de dias entre as regas (intervalo).
9. **% de ajuste sazonal:** permite programar o ajuste sazonal de 10 a 150% (o valor predefinido é de 100%).
10. **Sistema desligado:** indica que a rega está suspensa.
11. **Ativação/desativação manual:** indica quando a rega manual está programada. Permite ativar o setor de forma manual.
12. **MV:** indica que o setor 1 está definido como válvula mestre (disponível apenas em modelos de dois, quatro ou seis setores).
13. **Nível da bateria** – Indica a carga restante da bateria.
14. **Guarda-chuva:** indica que o sensor de chuva está suspendendo a rega.
15. **Guarda-chuva com um traço:** indica que o sensor de chuva foi suprimido manualmente.

CONEXÃO DA(S) BATERIA(S)

PT

O NODE usa uma ou duas baterias comuns de 9 V (não incluídas) para operar as válvulas e programar o controlador. O controlador pode funcionar com uma ou com duas baterias de 9 V. Em condições normais, a duração prevista é de um ano para uma bateria e de dois anos para duas baterias.



NOTA: o controlador NODE possui uma memória não volátil. Com isso, as informações dos programas não serão perdidas mesmo que a bateria seja removida.

Como instalar as baterias

1. Desenrosque a parte traseira do corpo do NODE para ter acesso ao compartimento das baterias.
2. Insira uma ou duas baterias no suporte e conecte-as ao controlador usando o conector de baterias.
3. Garanta que não haja água dentro do compartimento.
4. Enrosque novamente a parte traseira do NODE na parte frontal.



NOTA: confira se o marcador de vedação na metade traseira do NODE está alinhado com a metade frontal, garantido a vedação adequada.

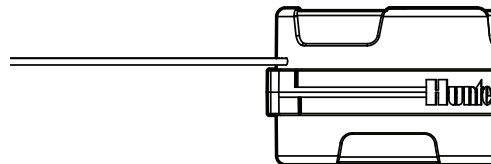
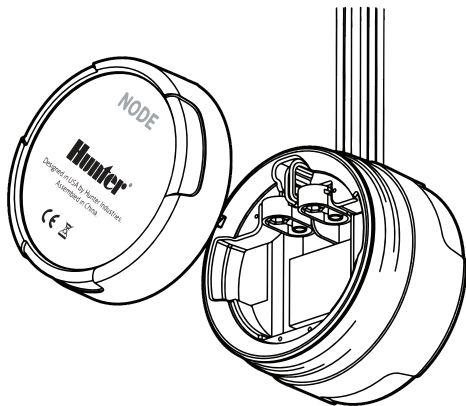

CONEXÃO DOS SOLENOIDES

PT

O NODE-100 é fornecido com um solenoide ligado ao controlador. O NODE-100-LS não inclui um solenoide. Os controladores de vários setores NODE-200, NODE-400 e NODE-600 controlam até dois, quatro ou seis solenoides, respectivamente. Os solenoides CC da Hunter (ref. 458200) podem ser facilmente instalados em todas as válvulas de plástico da Hunter.



NOTA: utilize **solenoides latching CC que funcionem com alimentação de 9 a 11 VCC. Solenoides de 24 VCA não funcionam com o NODE.**

Como conectar solenoides CC ao NODE

1. Ligue os terminais pretos de cada solenoide ao fio comum único (terminal preto) que sai do NODE. Proteja as conexões de todos os fios com conectores impermeáveis.
2. Ligue um fio vermelho de cada solenoide ao fio do respectivo setor (terminal vermelho) do NODE. Os números dos setores são identificados na superfície do NODE. Proteja as conexões de todos os fios com conectores impermeáveis.



NOTA: a distância máxima dos fios entre o solenoide e o NODE é de **30 m (100 pés)**, usando fios com bitola mínima de 1 mm (18 AWG).

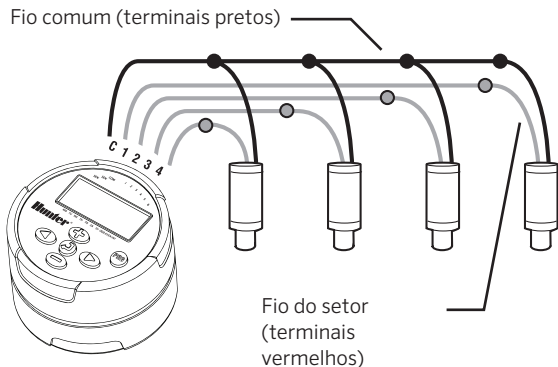

INSTALAÇÃO DO NODE

O NODE pode ser facilmente instalado em qualquer válvula de plástico da Hunter. O encaixe é feito rapidamente por meio de uma presilha de montagem especialmente projetada. Uma tampa protetora de borracha é fornecida para evitar que a sujeira se acumule na superfície do NODE.

Como instalar o NODE em uma válvula (Figura 1)

1. Enrosque o solenoide latching CC da Hunter (ref. 458200) no castelo da válvula.
2. Coloque a extremidade aberta menor do suporte do NODE na parte superior do solenoide.
3. Coloque o controlador NODE na extremidade aberta maior do suporte do NODE.





Figura 1

CONEXÃO DE UM SENSOR METEOROLÓGICO

Um sensor de chuva Mini-Clik® ou Rain-Clik® com fio da Hunter pode ser conectado ao NODE. O objetivo do sensor é interromper a rega de acordo com as condições meteorológicas.

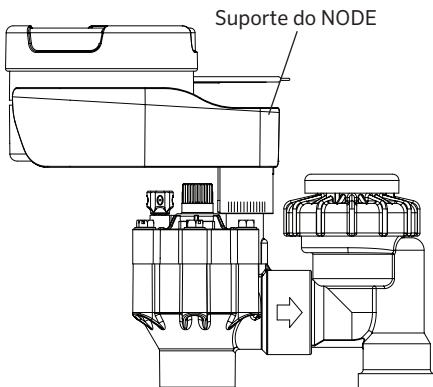

NOTA: quando o sensor de chuva estiver interrompendo a rega, o visor mostrará o ícone de Sistema desligado (OFF), "OFF" (Desligado) e o símbolo .

1. Corte o anel amarelo ligado ao NODE, aproximadamente no meio dele.
2. Desencape cerca de 13 mm (1/2") de cada fio. Ligue cada fio amarelo aos respectivos fios do sensor meteorológico. O sensor de chuva pode ser instalado a até 30 m (100 pés) do controlador NODE (bitola mínima do fio de 1,0 mm/18 AWG).
3. Proteja as conexões dos fios com conectores impermeáveis.

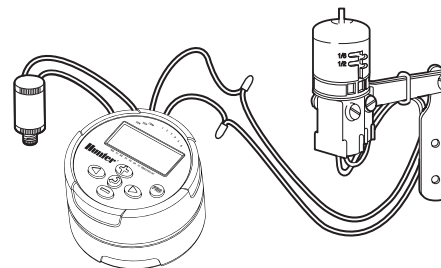

Modelo Mini-Clik® da Hunter

MODO INATIVO

Normalmente, o visor do NODE mostra a hora e o dia, o dia da semana, MV (se a opção de válvula mestre estiver ativada) e o indicador de nível das baterias. Após um curto período de inatividade, o visor é desligado para economizar bateria. Quando qualquer botão é pressionado, o NODE sai do modo inativo.

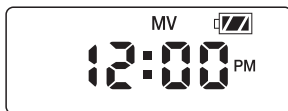





MODO DE REGA

Quando o controlador está a operando um programa, os itens exibidos no visor incluem o número do setor, a letra do programa, o tempo de rega restante e o ícone do rotor, que fica piscando.















PROGRAMAÇÃO

PT

O NODE utiliza a programação padrão da Hunter com três programas (A, B ou C) e quatro horários de início por programa. Nos controladores convencionais da Hunter, um seletor giratório é usado para percorrer as funções de programação. Já no controlador NODE, o botão  é usado para criar o programa de rega de forma rápida e fácil. Durante a programação, os itens que estão piscando no visor podem ser alterados por meio dos botões  ou . Para alterar um item que não esteja piscando, pressione os botões  ou  até que o item desejado comece a piscar.



Ajuste de data e hora

1. Pressione o botão  até que o ícone  seja mostrado.
2. Serão exibidos os quatro dígitos que representam o ano. Utilize os botões  ou  para alterar o ano. Pressione o botão  para ir para o ajuste do mês.
3. Serão mostrados quatro dígitos. Os dois dígitos piscando à esquerda representam o mês. Utilize os botões  ou  para alterar o mês. Pressione o botão  para ir para o ajuste do dia.
4. Serão mostrados apenas os dois dígitos da direita correspondentes ao dia, que estarão piscando. Pressione os botões  ou  para alterar o dia. Pressione o botão  para ir para o ajuste da hora.
5. O ajuste de hora AM/PM/24 horas ficará piscando. Pressione os botões  ou para alterar o formato da hora entre AM/PM (manhã e tarde) ou 24 horas. Pressione o botão para ir para o ajuste das horas.

PROGRAMAÇÃO (CONTINUAÇÃO)

PT

1. Serão mostrados quatro dígitos. Os dois números piscando à esquerda representam a hora. Utilize os botões ou para alterar a hora. Pressione o botão para ir para o ajuste dos minutos.
2. Serão mostrados quatro dígitos. Os dois números piscando à direita representam os minutos. Utilize os botões ou para alterar os minutos. Se o botão for pressionado, o visor voltará para o ajuste do ano do Passo 2.
3. Pressione o botão para avançar para a próxima função de programação ou permitir que o controlador volte ao modo inativo.



Ajuste dos horários de início da rega

1. Pressione o botão até que o ícone seja mostrado.
2. O horário de início aparecerá piscando, juntamente com a letra do programa (A, B ou C) e o número do horário de início (1, 2, 3 ou 4) na parte superior esquerda do visor. É possível definir até quatro horários de início diferentes para cada programa.
3. Utilize os botões ou para alterar o horário de início do programa mostrado. A cada vez que o botão é pressionado, o horário de início é alterado em incrementos de um minuto.
4. Para adicionar um novo horário de início para o programa mostrado, utilize o botão . O número do horário de início aparece no canto superior esquerdo do visor.
5. Pressione o botão para adicionar horários de início a um programa diferente.

6. Pressione o botão para avançar para a próxima função de programação ou permitir que o controlador volte ao modo inativo.



NOTA: após programar o tempo de rega do último setor, pressione o botão para ver o tempo de rega total do programa.

Ajuste dos tempos de rega

1. Pressione o botão até que o ícone seja mostrado.
2. O tempo de rega ficará piscando. Também serão mostrados a letra do programa (A, B ou C) e o número do setor ativo na parte inferior esquerda do visor. Pressione os botões ou para alterar o tempo de rega do setor de um minuto até seis horas.
3. Pressione o botão para avançar para o próximo setor.
4. Pressione o botão para adicionar um tempo de rega a outro programa.
5. Pressione o botão para avançar para a próxima função de programação ou permitir que o controlador volte ao modo inativo.



Ajuste dos dias de rega

1. Pressione o botão até que o ícone seja mostrado.
2. Será mostrada a letra do programa (A, B ou C).
3. As setas indicam os dias específicos da semana em que a rega irá ocorrer. Utilize os botões ou para percorrer os dias.
4. Pressione o botão para ativar o dia desejado para o programa mostrado, ou pressione o botão para cancelar a rega desse dia. **A seta será mostrada nos dias de rega para o programa ativo.**
5. Se desejar, pressione o botão para definir os dias de rega para um programa diferente.
6. Pressione o botão para avançar para a próxima função de programação ou permitir que o controlador volte ao modo inativo.

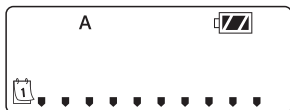

Seleção de rega em dias pares/ímpares

Esse recurso usa a numeração dos dias do mês para efetuar a rega, em vez dos dias da semana.

1. Pressione o botão até que o ícone seja mostrado.
2. Pressione o botão até que o cursor esteja sobre ODD (Ímpar) ou EVEN (Par) no visor.
3. Pressione o botão para selecionar, ou o botão para cancelar os dias pares ou ímpares de rega.
4. Quando o modo ODD (Ímpar) ou EVEN (Par) estiver ativado, seu cursor será o único mostrado no visor.

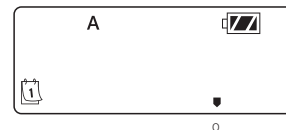

Seleção de rega em intervalos de dias

1. Pressione o botão até que o ícone seja mostrado.
2. Pressione o botão até que o cursor esteja sobre INT (Intervalo) no visor.
3. Pressione o botão . O número 1 ficará piscando, indicando o número de dias entre as regas.
4. Pressione os botões ou para selecionar o número de dias entre as regas (de 1 a 31).

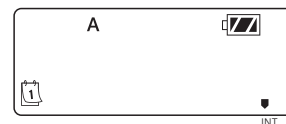



Definição do ajuste sazonal

1. Pressione o botão até que o ícone seja mostrado.
2. Pressione os botões ou para aumentar ou diminuir o valor do ajuste sazonal em relação ao valor padrão de 100% (entre um valor mínimo de 10% e máximo de 150%).
3. O valor programado para o ajuste sazonal será aplicado a todos os programas de rega e terá efeito imediato nos tempos de rega exibidos. Por exemplo, se forem programados tempos de rega de 20 minutos e, em seguida, o ajuste sazonal for alterado de 100% para 50%, os tempos de rega exibidos serão de 10 minutos.



Desligamento do sistema







Para desligar o controlador, pressione o botão  até que os ícones  e **OFF** (Desligado) apareçam na tela. Para o controlador voltar ao modo de programação automática, pressione o botão .





O controlador voltará imediatamente ao modo de programação automática e mostrará a hora e o indicador de nível das baterias.



Rega manual





A rega manual permite que o usuário teste cada setor ou um programa para um tempo de rega especificado. Nesse modo, a condição do sensor meteorológico (se utilizado) será ignorada.

1. Garanta que o controlador esteja no modo inativo. Segure o botão  até que o ícone  seja mostrado.
2. O número do setor aparecerá na parte inferior esquerda do visor, juntamente com o tempo de rega.
3. Utilize os botões  e  para selecionar o setor desejado, e os botões  e  para definir o tempo de rega manual para o setor mostrado.

4. Para ativar um programa de forma manual, utilize o botão . A letra do programa (A, B ou C) será exibida na tela. Se for necessário usar um programa diferente, pressione o botão  até que o programa desejado apareça.
5. Para interromper o ciclo da rega manual, pressione o botão  até que tempo seja zerado.
6. Pressione o botão  para avançar para a próxima função de programação ou permitir que o controlador volte ao modo inativo.



NOTA:

- Se os botões  ou  forem usados quando um setor estiver irrigando no modo manual, o tempo de irrigação desse setor será alterado.
- Se o botão  for usado quando um setor estiver irrigando no modo manual, a irrigação do setor atual será interrompida e avançará para o setor seguinte.
- Se o botão  for usado quando um setor estiver irrigando no modo manual, a irrigação do setor atual será interrompida e voltará para o setor anterior.

Funcionamento do sensor

O NODE é compatível com os sensores de chuva do tipo "Clik" da Hunter, como Mini-Clik®, Freeze-Clik e Rain-Clik® com fio, bem como muitos outros dispositivos/sensores de interrupção que não exijam alimentação. Basta conectar o sensor ao controlador NODE, cortando o anel amarelo e ligando os fios do sensor.



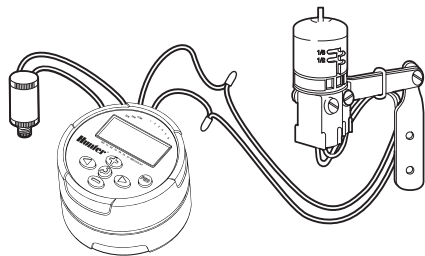

NOTA: o controlador NODE não é compatível com o Rain-Clik® sem fio da Hunter ou outros dispositivos meteorológicos que exijam alimentação de 24 VCA.

Quando o sensor for ativado, a irrigação será suspensa e o ícone  será exibido no visor.





Todas as funções de programação avançadas são iniciadas no modo inativo, que mostra a hora, o dia da semana e o indicador de nível das baterias. Se algo estiver piscando no visor, isso significa que o controlador está em um dos modos de programação. Após um curto período de inatividade, o controlador volta ao modo inativo.



Supressão do sensor

1. No modo inativo, segure o botão  até que o ícone  seja mostrado.
2. O visor exibirá um ícone de guarda-chuva piscando e **ON** (Ligado).



3. Pressione o botão  para suprimir o sensor. Com isso, o visor mostrará o ícone  e **OFF** (Desligado) para indicar que o sensor meteorológico foi suprimido. O ícone  será exibido no visor durante o funcionamento normal, indicando que o controlador está no modo de supressão.





4. Para reativar o sensor meteorológico, segure o botão  até que o ícone  apareça. Pressione o botão  para voltar ao modo de sensor normal.

Memória Easy Retrieve



Essa função permite salvar um programa preferido na memória permanente no controlador, que poderá ser restaurado em qualquer momento. Essa é uma excelente forma de anular alterações que tenham sido feitas e voltar às programações originais.

Para salvar um programa:

1. Verifique se o controlador está programado com a programação preferida.
2. No modo inativo, segure os botões  e  por cinco segundos para salvar o programa atual.
3. Aparecerão três pequenos traços na tela indo da esquerda para a direita, indicando que o programa atual está sendo salvo na memória permanente. Quando o processo terminar, a palavra **Done** (Concluído) aparecerá piscando na tela.



Para recuperar um programa salvo:

1. No modo inativo, segure os botões  e  por cinco segundos.
2. Aparecerão três pequenos traços na tela indo da direita para a esquerda, indicando que o programa preferido está sendo recuperado da memória.



Com isso, o programa atual do controlador será o programa preferido. Quando o processo terminar, a palavra **Done** (Concluído) aparecerá piscando na tela.



NOTA: tenha cuidado ao usar a memória Easy Retrieve. Quando os dados do programa são salvos na memória por meio dessa função, as informações do programa atual substituem aquilo que está salvo na memória permanente. Ao salvar os dados do programa, verifique se os dados do programa atual são realmente os que você pretende salvar.

Ajuste do funcionamento da válvula mestre (somente para NODE-200, NODE-400 e NODE-600)

Os modelos do NODE para vários setores (NODE-200, NODE-400 e NODE-600) podem ser programados utilizando uma válvula mestre normalmente fechada. Ao programar com a válvula mestre, o setor 1 será especificado como válvula mestre, o que significa que não poderá ser usado para ativar um setor de rega.

1. No modo inativo, pressione o botão  até que o ícone  seja exibido.
2. O programa A será mostrado juntamente com o número do setor ativo na parte inferior esquerda. Confira se o setor ativo exibido é o "1". Será mostrado o tempo de rega.





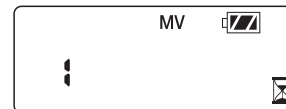

3. Pressione o botão  uma vez. O ícone **MV** (Válvula mestre) será mostrado na tela e o tempo irá desaparecer. Com isso, o setor 1 atuará como válvula mestre e não estará disponível em outras telas de programação.



4. Quando a válvula mestre estiver ativada, ela será aplicada a todos os programas, e o ícone **MV** ficará sempre na tela.





Interrupção programável (até 99 dias)

Esse recurso permite interromper todas as regas programadas durante um período especificado de 1 a 99 dias. Ao fim desse período, o controlador voltará ao funcionamento normal.

1. No modo inativo, pressione o botão  até que o ícone  seja mostrado. Aguarde dois segundos até que **OFF** (Desligado) apareça na tela. Com isso, o controlador estará no modo Sistema Desligado.
2. Pressione o botão . O número 1 ficará piscando, indicando o número de dias que o controlador permanecerá desligado. Programe os dias em que o sistema ficará desligado, conforme desejado, até um máximo de 99 dias.
3. O visor mostrará o número de dias restantes do período desligado.
4. Para interromper esse período, pressione o botão  para voltar à tela do modo inativo, que mostra a hora e o dia da semana.

INDICADOR DO NÍVEL DAS BATERIAS







É possível ter uma estimativa da carga restante da(s) bateria(a) por meio do indicador mostrado no visor. O NODE pode funcionar com uma ou duas baterias de 9 V. Se duas baterias forem usadas, a duração será praticamente o dobro da duração de uma única bateria. Abaixo você pode ver a estimativa da carga restante de acordo com as figuras.

-  Cheia: 100-60% de carga
-  Média: 60-25% de carga
-  Baixa: 25-0% de carga
-  Substitua a bateria imediatamente!

REDEFINIÇÃO DO CONTROLADOR

PT

Quando o controlador é redefinido, os dados do programa atual são apagados e o controlador é reiniciado. Porém, a redefinição não exclui um programa preferido salvo na memória permanente com a função de memória Easy Retrieve (veja a página 12).

1. No modo inativo, segure os botões ,  e .
2. Após dois segundos, a tela ficará em branco. Continue segurando os botões ,  e .
3. 12:00 ficará piscando no visor. Solte os botões.
4. O controlador poderá exibir uma contagem regressiva de 10 até 1. Quando a redefinição for concluída, 12:00 AM ficará piscando. Com isso, o controlador poderá ser reprogramado.

Problema	Causas	Soluções
Nada aparece no visor.	O visor está desligado. A bateria acabou.	Pressione qualquer botão por um segundo. Substitua a bateria.
O visor indica rega, mas nada acontece.	A água está sem pressão. O solenoide está com defeito. O solenoide não é compatível.	Ligue a alimentação do sistema principal. Substitua o solenoide. Deve ser usado um solenoide latching CC da Hunter (ref. 458200) ou outro solenoide latching CC compatível.
A rega automática não começa no horário de início.	O controlador está no modo Sistema Desligado. A opção AM/PM da hora do dia não está definida corretamente. A opção AM/PM do horário de início não está definida corretamente.	Verifique se o controlador está programado para a rega automática. Corrija a opção AM/PM da hora do dia. Corrija a opção AM/PM do horário de início.
O sensor de chuva não suspende a rega.	O sensor de chuva está com defeito ou a ligação está incorreta.	Verifique se sensor de chuva está funcionando corretamente e se as ligações estão certas (veja a página 10).
O controlador irriga mais de uma vez.	O programa tem mais de um horário de início atribuído a ele. Cada programa tem até quatro horários de início.	Elimine horários de início do programa, conforme necessário.

ESPECIFICAÇÕES

PT

Dimensões: 89 mm (3 ½") de diâmetro, 64 mm (2 ½") de altura

Entradas de sensor: Uma

Alimentação: uma bateria alcalina de 9 V (utilize duas para aumentar a duração). Ativa solenoides latching CC que funcionam a 9-11 VCC (ref. da Hunter: 458200)

Temperatura de funcionamento: -17 °C a 60 °C (0 °F a 140 °F)

Certificações:

IP68

CE

FCC

C-Tick

NODE ÖZELLİKLERİ	2
NODE BİLEŞENLERİ	3
Kontrol Tuşları	
LCD Ekranı	
PİLİN / PİLLERİN BAĞLANMASI	4
LATCHİNG SELENOİD BAĞLANMASI	5
DC Solenoidin NODE 'a bağlanması	
NODE'un bir vanaya monte edilmesi (Şekil 1)	
NODE 'UN MONTAJI	6
HAVA SENSÖRÜNÜN BAĞLANMASI	6
Tarih ve saatin kurulumu	
RÖLANTİ MODU	7
ÇALIŞMA MODU	7
PROGRAMLAMA	7
Sulama Zamanının Girilmesi	
Çalışma Süresinin Girilmesi	
Sulama Günlerinin Girilmesi	
Tek veya Çift Günlerin Seçilmesi	
Sulama Gün Aralıklarının Seçimi	
Mevsimsel Ayarların Girilmesi	
Sistemin Kapatılması	
Manuel Sulama	
Sensör Uygulaması	
GELİŞMİŞ PROGRAMLAMA ÖZELLİKLERİ	12
Sensorun Atlatılması	
Kolay Erişilebilen Hafıza	
Ana Vana Ayarları (Sadece NODE-200, NODE-400, & NODE-600 'de)	
Programlanabilir Kapatma (99 güne kadar)	
Hunter Hızlı Test Özelliği	

PİL ÖMRÜ GÖSTERGESİ	14
KONTROL CİHAZINI YENİDEN AYARLAMAK/RESETLEMEK	14
ARIZA GİDERME VE TEKNİK ÖZELLİKLER	15
ŞARTNAME	16
NOTLAR	17



- Basitçe düğmeye basarak programlama
- DC-latching solenoidi içeren tek istasyonlu model (NODE-100). Ayrıca tek, iki, dört veya altı istasyonlu modeller de sunulur (solenoidler dahil değildir).
- Anlaşılır simgelere sahip geniş Likit Kristal Ekran (LCD)
- En az bir adet standart dokuz voltluk alkalin pil ile çalıştırılır (uzun pil ömrü için iki adet kullanın)
- Her birinde dört adede kadar başlangıç zamanı bulunan üç program (A, B veya C)
- Bir dakikadan altı saate kadar çalışma süreleri
- Manuel sulama özellikleri
- Pil ömrü göstergesi
- Kablolulu yağmur sensörü uyumlu
- Kalıcı bellek tüm program bilgisini hafızasında tutma
- %10' dan %150 ye kadar mevsimsel ayarlama
- Easy Retrieve™ (Kolay Yenilenebilir) bellek, istenen program verilerinin kaydedilmesine/alınmasına olanak sağlar
- Yağmur sensörünü manuel atlama
- Bu bölümde bazı NODE bileşenlerine yönelik genel bakış sunulur

Bu bölümde bazı NODE bileşenlerine yönelik genel bakış sunulur. Her bir detay daha sonra ayrıntılı olarak incelenecektir. Yine de bu bölüm farklı kullanma opsiyonları ile tanışmanız için size yardımcı olacaktır.

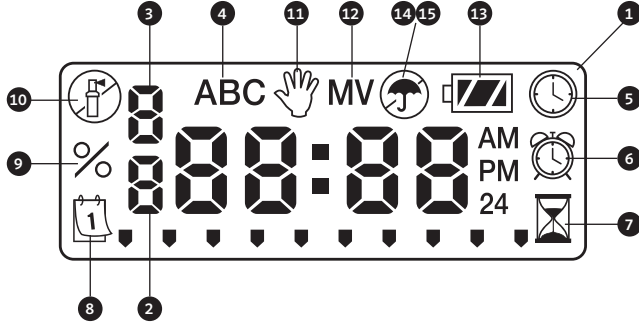

Kontrol Düğmeleri

1. **İşareti** - Ekranda yanıp sönen seçili öğeyi artırır.
2. **İşareti** - Ekranda yanıp sönen seçili öğeyi azaltır.
3. **İşareti** - Programlama fonksiyonunu seçer.
4. **İşareti** - Ekranda yanıp sönen seçili öğeyi bir sonraki öğeye ilerletir.
5. **İşareti** - Ekranda yanıp sönen seçili öğeyi bir önceki öğeye ilerletir.
6. **İşareti** - Programı seçer (A, B, veya C)

LCD Ekran

1. **Ana Ekran** - Tüm program bilgilerini gösterir.
2. **İstasyon Numarası** - Seçilmiş olan istasyon numarasını gösterir.
3. **Başlama Zamanı Numarası** - Programlanan seçili başlama zamanı numarasını gösterir.
4. **Programa** - Programı gösterir. (A, B, veya C)
5. **Geçerli Zaman/Gün** - Geçerli Gün/Zaman 'ın ayarlandığı dilimi gösterir.
6. **Başlama Zamanı** - Başlama zamanlarının ayarlandığı dilimi gösterir.
7. **Çalışma Zamanı** - Çalışma zamanlarının ayarladığı dilimi gösterir. Kullanıcıların bir dakikadan altı saate kadar çalışma süresi ayarlamasına olanak sağlar.
8. **Sulama Günleri** - Kullanıcıya sulama günlerini bağımsız olarak veya sulama aralıklarındaki gün sayısını seçmesini sağlar.
9. **% Mevsimsel ayarlama** - %10 dan %150 ye kadar mevsimsel olarak programlanabilir. (sabit değeri %100)
10. **Sistem kapalı** - Sulamanın ertelendiğini gösterir.
11. **Manual Açma/kapama** - Manuel sulamanın programlandığını gösterir. Kullanıcının istasyonu manuel aktive etmesini sağlar.
12. **MV - Birinci istasyonun ana vana** - çalışması için ayarlandığını belirtir (yalnızca iki, dört veya altı istasyonlu modellerde mevcuttur)
13. **Pil Göstergesi** - Kalan pil ömrünü gösterir.
14. **Şemsiye** - Yağmur sensörünün sulamayı ertelediğini gösterir.
15. **Üstü Çizili Şemsiye** - Yağmur sensörünün manuel olarak atlatıldığını gösterir.

PİL/PİLLERİN BAĞLANTISI

TR

NODE, vanaları çalıştırmak ve kontrol ünitesini programlamak için bir veya iki adet standart dokuz voltluk pil (dahil değildir) kullanır. Kontrol ünitesi, bir veya iki adet dokuz voltluk pil kullanılarak çalıştırılabilir. Normal koşullarda tahmini kullanım ömrü, tek pil için bir yıl ve iki adet dokuz voltluk pil için iki yıldır.



NOT: NODE kalıcı belleği sayesinde.Bu da program bilgileri kaybedilmeden pilin çıkarılmasına olanak sağlar.

Pilin/Pillerin Montajı

1. Batarya bölümüne ulaşmak için NODE 'un alt kısmını çevirerek açınız.
2. Pili/ pilleri pil yuvasına yerleştiriniz ve pil bağlantısını kullanarak kontrol ünitesine bağlayınız.
3. Pil yuvasına su kaçmadığından emin olun.
4. Batarya bölümünü tekrar üst kısım ile çevirerek birleştiriniz.



NOT: Uygun sızdırmazlığı sağlamak için NODE'nin arka yarısındaki sızdırmazlık işaretinin ön yarısı ile üst üste geldiğini doğrulayınız geldiğinden emin olun.

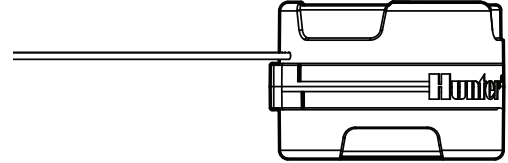
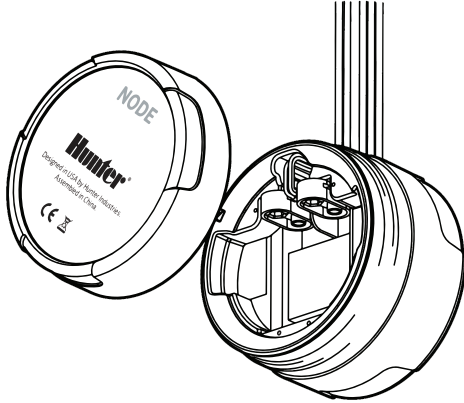

SOLENOİDLERİN BAĞLANMASI

TR

NODE-100, kontrol ünitesine takılı bir solenoid ile gönderilir. NODE-100-LS solenoid içermez. NODE-200, NODE-400 ve NODE-600 çok istasyonlu kontrol üniteleri, sırasıyla iki, dört veya altı adede kadar solenoid ile çalışır. Hunter DC-latching solenoidler (P/N 458200), tüm Hunter plastik vanalarına kolaylıkla takılabilir.



NOT: 9-11 VDC arasında çalışan DC latching solenoidler kullanın. 24 VAC solenoidler, NODE ile çalışmayacaktır.

DC Solenoidlerin NODE'a kablolanması

1. Her bir solenoid bobinden gelen siyah kabloları, NODE 'dan gelen tek ortak kabloya (siyah kablo) bağlayınız. Bütün kablo bağlantılarınızı su geçirmez birleştiriciler ile güvence altına alın.
2. Her bir solenoid bobinden gelen kırmızı kabloları NODE 'dan gelen uygun istasyon kablosuna (kırmızı kablo) bağlayınız. İstasyon numaraları NODE 'un ön yüzünde belirtilmiştir. Bütün kablo bağlantılarınızı su geçirmez birleştiriciler ile güvence altına alın.



NOT: Solenoid ve NODE arasındaki maksimum kablo mesafesi, 1 mm (18 AWG) kablo boyutu ile 30 m'dir (100').n.

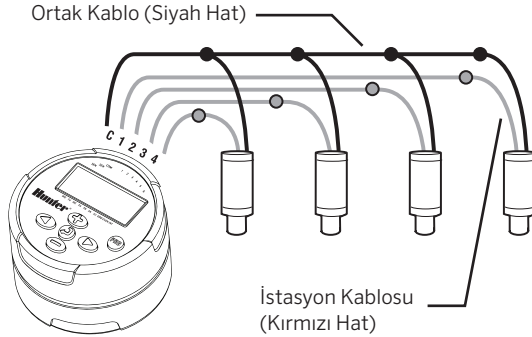

NODE' UN MONTAJI

NODE kolaylıkla herhangi bir Hunter vanasına monte edilebilir. Özel olarak tasarlanmış vana montaj aparatı montajı basit bir hale getirir. Kauçuk koruma kapağı, NODE 'un yüzeyinde biriken kirden korunmasını sağlar.

NODE 'un bir vanaya bağlanması (Şekil1)

1. Hunter DC latching solenoidi (P/N 458200) vana başlığına vidalayın.
2. NODE'nin küçük açık ucunu solenoidin üst kısmına ayarlayın.
3. NODE kontrol ünitesini NODE tutucusunun büyük açık ucuna ayarlayın.

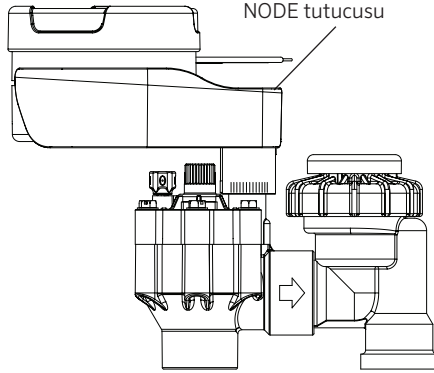

Şekil 1

HAVA SENSORÜ BAĞLAMA

TR

Hunter Mini-Clik® veya Kablolu Rain-Clik® yağmur sensörü NODE'ye bağlanabilir. Bu sensörün bağlanması temel amacı, hava koşullarının uygun olmadığı zamanlarda sulamanın durdurulmasıdır.



NOT: Kablolu Yağmur Sensörü sulamaya müdahale ederken ekranda Sistem Kapalı simgesi , "OFF" ve gösterilir.ktır.

1. NODE kontrol ünitesine bağlı sarı halka şeklindeki kabloyu ortasından kesiniz.
2. Her bir kablodan yaklaşık 13 mm kısmı kablolardan sıyrınız. NODE dan gelen her bir sarı kabloyu tek tek sensörden gelen kablolarla bağlayınız. Yağmur sensörünü NODE kontrol ünitesinden 30 m'ye (100 ft) uzağa monte edebilirsiniz (1 mm/18 AWG minimum kablo boyutu)
3. Bütün kablo bağlantılarınızı su geçirmez birleştiriciler ile güvence altına alın.

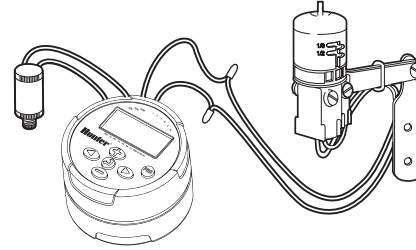

Hunter Mini-Clik® Modeli

RÖLANTİ MODU

Normal koşullarda NODE ekranında saat ve gün, hafta günü, MV (ana vana seçeneği etkinse) ve pil ömrü göstergesi gösterilir. Bir süre hiçbir işlem yapılmazsa ekran, pil gücünü korumak için kapanır. Herhangi bir tuşa basarak NODE'yi rölanți modundan çıkarabilirsiniz.







ÇALIŞMA MODU

Kontrol ünitesi bir program çalıştırırken ekranda istasyon numarası, program harfi, kalan çalışma süresi ve bir yanıp sönen Rotor simgesi gibi öğeler gösterilir.

















PROGRAMACIÖN







TR

NODE Hunter control ünitesinin kullandığı 3 program (A,B,C) NODE, üç program (A, B veya C) ve her program başına üç başlangıç zamanı ile standart Hunter kontrol ünitesi programlamasını kullanır. Standart Hunter kontrolörleri üzerindeki bir kadrın programlama fonksiyonları arasında dolaşmak için kullanılır, ancak, NODE da ise  sembolü hızlı ve kolay bir şekilde sulama programı oluşturmak için kullanılır. Programlama yaparken ekranda yanıp sönen bölümle  sembolüne veya  sembolüne basarak değiştirilir. Yanıp sönmeyen bir öğeyi değiştirmek için,  veya  tuşlarına seçilen öğenin işaretinin yanıp sönmeye başlamasına kadar basılır.



Tarih ve Zaman Ayarı







1. Zaman  ikonu görünene dek  düğmesine basınız.
2. Yılı temsil eden dört rakamın tamamı görüntülenir.  veya  tuşlarını yılı değiştirmek için kullanınız.  tuşuna basarak ay ayarına geçin.
3. Dört rakamın sol tarafında yanıp sönen iki rakam ayı temsil eder.  veya  tuşlarını ayı değiştirmek için kullanınız.  tuşuna basarak gün ayarına geçin.
4. Yalnızca sağ tarafta 2 basamak yanıp sönmeye başlayarak günü temsil edecek şekilde görüntülenecektir. Günü değiştirmek için  veya  düğmelerine basın.  tuşuna basarak saat ayarını değiştirmeye geçin.  tuşuna basarak zamanı ayarlamaya başlayın.
5. AM/PM/24 saatlik zaman ayarı yanıp sönmeye başlayarak gösterilir.  veya  tuşlarını ile AM yada PM yada Türkiyede kullanılan 24 saat zaman dilimi seçilebilir  tuşuna basarak saat ayarını değiştirmeye geçin.

6. Dört rakamın sol tarafında yanıp sönen iki rakam saati temsil eder.  veya  tuşlarını saati değiştirmek için kullanınız.  tuşuna basarak dakika ayarını değiştirmeye geçin.
7. Dört rakamın sağ tarafında yanıp sönen iki rakam dakikayı temsil eder.  veya  tuşlarını dakikayı değiştirmek için kullanınız.  tuşuna basarak yıl ayarından sonraki 2 adıma geçilir.
8.  düğmesine basıldığında yıl ayarında 2. Adım'a geçilir.









NOT: Son istasyonun da çalışma zamanı programlandıktan sonra  tuşuna basarak program için toplam çalışma zamanı görüntülenir.

Sulama Başlama Zaman Ayarı









1. Zaman  ikonu görünene dek  düğmesine basınız.
2. Başlama zamanı program harfleri (A, B veya C) ve başlama zaman numaraları (1, 2 ,3 veya 4) üst sol köşesinde olacak şekilde yanıp sönecek şekilde görüntülenecektir. Her programa 4 değişik başlama zamanına kadar programlama yapılabilir.
3.  veya  tuşlarını kullanarak ekranda görünen program için başlama zamanı değiştirilebilir. Düğmeye her bastığınızda başlangıç zamanı bir dakikalık artışlarla değiştirilir.
4.  tuşuna basarak ekrandaki programa ilave bir başlangıç zamanı verilir. Başlama zamanı numarası ekranın sol üst köşesinde bulunur.
5.  tuşuna basarak farklı programlara başlama zamanı girilir.
6.  tuşuna basarak bir sonraki programlama fonksiyonuna geçilebilir yada kontrol ünitesinin rölanti moduna geri dönmesine izin verilir.

Çalışma Süresini Ayarlama

1.  ikonu görünene dek  düğmesine basınız.
2. Çalışma süresi yanıp sönmeye başlayacaktır. Ayrıca, ekranın sol alt kısmında etkin istasyon numarası ve program harfi (A, B veya C) gösterilir. Çalışma süresini bir dakika ile altı saat arasında değiştirmek için  veya  düğmelerine basın.
3.  tuşuna basarak bir sonraki istasyona geçilir.
4.  tuşuna basarak başka bir programa çalışma süresi eklenir.
5.  tuşuna basarak bir sonraki programlama fonksiyonuna geçilebilir yada kontrol ünitesinin rölanti moduna geri dönmesine izin verilir.





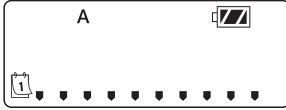

Sulama Günlerinin Programlanması

1.  ikonu görüldükten sonra  düğmesine basınız.
2. Program harfi (A, B, ve C) görüntülenecektir.
3. Oklar, sulamanın gerçekleşeceği belirli hafta günlerine işaret eder.  veya  tuşlarına basarak günlerin arasında gezebilirsiniz.
4.  tuşuna basarak ekranda görünen program için o gün aktive edilir veya  tuşuna basarak o gün için sulama iptal edilir. **Ok aktif program için sulama günlerini gösterecektir.**
5.  tuşuna basarak, istenmesi durumunda farklı bir program için sulama günleri girilir.
6.  tuşuna basarak bir sonraki programlama fonksiyonuna geçilebilir yada kontrol ünitesinin rölantri moduna geri dömesine izin verilir.



Sulama İçin Tek/Çift Günlerin Seçilmesi





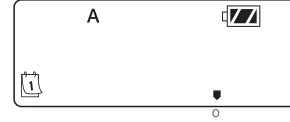

Bu özellik sulama için haftanın günleri yerine, ayın sayılı günlerini kullanır.

1.  ikonu görüldükten sonra  düğmesine basınız.
2.  tuşuna ok TEK / ÇİFT (odd/even) ibaresinin üzerine gelinceye kadar basılı tutun.
3.  Tuşuna basarak seçim yapılırken,  tuşuna basarak yapılan seçim TEK / ÇİFT (odd/even) sulama günleri için iptal edilir.

4. ODD-TEK veya EVEN-ÇİFT gün özelliği aktive edildiğinde ekranda aşağıdaki şekil gibi tek bir ok olacaktır.





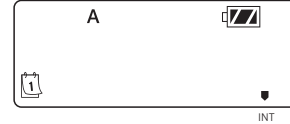

Sulama İçin Günlerin Aralıklı Seçilmesi

1.  ikonu görüldükten sonra  düğmesine basınız.
2.  tuşuna ok INT ibaresinin üzerine gelinceye kadar basılı tutun.
3.  tuşuna basıldığında, sulama günleri arasındaki gün sayısını gösteren 1 yanıp sönmeye başlayacaktır.
4. Sulama günleri arasındaki gün sayısını seçmek için (1 ila 31)  veya  düğmelerine basın.



Mevsimsel Ayarlama

1.  ikonu görüldükten sonra  düğmesine basınız.
2.  veya  tuşları kullanılarak mevsimsel ayar değeri fabrika değeri olan %100'e göre azaltılır yada çoğaltılır. (minimum %10'a, maksimum %150'ye kadar)
3. Mevsimsel ayarlama için girilen değer tüm sulama programlarına uygulanacak ve ivedilikle çalışma sürelerine yansıtılacaktır. Örneğin; 20 dakikalık çalışma süreleri programlanırsa ve mevsim ayarı %100'den %50'ye değiştirilirse görüntülenen çalışma süreleri 10 dakika olacaktır.



Sistemin Kapatılması

Kontrol ünitenizi kapatmak isterseniz tuşuna ikonu ve **OFF** yazısını ekranda görüntüleninceye kadar basın. Kontrol ünitenizin otomatik programlama modu için de tuşuna basın. Kontrol ünitesi anında otomatik programlama moduna döner ve saat ile pil ömrü göstergesini görüntüler.



Manuel Sulama

Manuel Sulama kullanıcıya her bir istasyonu veya bir programdaki belirli bir çalışma süresini test etmeye izin verir. Hava sensörü durumu (kullanılıyorsa) bu modda kullanılmaz.

1. Kontrol ünitesinin rölaneti modunda olduğundan emin olun. tuşuna ikonu ekrana gelene dek basılı tut.
2. İstasyon numarası ekranın sol alt kenarında beraberinde çalışma zamanı ile görüntülenecektir.
3. ve tuşları ile istenilen istasyon seçilir ve ve tuşları ile manuel sulama süresi seçilen istasyona girilir.

4. Manuel olarak programı aktive etmek için, tuşuna basın. Program harfi (A,B veya C) ekranda görünecektir. Eğer değişik bir program gerekirse, tuşuna istenilen program gelene dek basılır.
5. Manuel sulama döngüsünü durdurmak için, tuşuna zaman sıfıra düşünceye kadar basılı tutun.
6. tuşuna basarak bir sonraki programlama fonksiyonuna geçilebilir yada kontrol ünitesinin rölaneti moduna geri dönmesine izin verilir.



NOT:

- **Bir istasyon Manuel sulama modunda çalışırken veya düğmelerine basarsanız söz konusu istasyon için sulama zamanını değiştirmiş olursunuz.**
- **tuşuna basıldığında, manuel sulama çalışma sürecinde olan istasyon sulamayı durduracak ve bir sonraki istasyona ilerleyecektir.**
- **tuşuna basıldığında, manuel sulama çalışma sürecinde olan istasyon sulamayı durduracak ve bir önceki istasyona geri dönecektir.**

Sensör Bağlantısı

NODE; Mini-Click®, Freeze-Click ve Kablolü Rain-Click® dahil olmak üzere Hunter Click türü yağmur sensörleriyle ve güç gerektirmeyen ve sulamaya müdahale eden diğer birçok aygıtlar/sensörlerle uyumludur. Basitçe sensörün NODE kontrol ünitesine bağlantısı sarı halka biçimdeki kabloyu kesip ve bu kabloyu sensör kablolarına bağlayarak gerçekleştirilir.



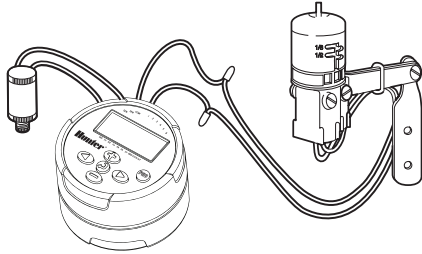

NOT: NODE Hunter kablosuz Rain-Click® veya 24VAC enerji gerektiren diğer hava araçları ile uyumlu değildir..

Sensör aktive edildiğinde, sulama ertelenecek ve  ikonu ekranda görülecektir.





Tüm gelişmiş programlama işlevleri, ekranda saati, hafta gününü ve pil ömrü göstergesini gösteren rölanli modundan başlatılır. Eğer ekranının üzerinde herhangi yanıp sönen bir şekil varsa ,bu kontrol ünitesinin herhangi bir programlama modunda olduğunu gösterir. Kısa bir süre hiçbir işlem yapılmazsa kontrol ünitesi rölanli moduna geri döner.

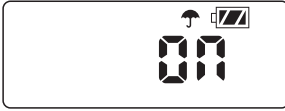

Sensörün Atlatılması

1. Rölanli modunda,  simgesi görüntülenene kadar  düğmesini basılı tutun.
2. Ekranda şemsiye ikonu yanıp söndüğünü ve “ON” –“AÇIK” yazısı görüntülenecektir.



3. Sensörü atlatmak için  tuşuna basın. Hava durumu sensörünün atlandığını belirtmek için ekranda  simgesi ve OFF (Kapalı) görüntülenir.





4. Hava sensörünü tekrar aktif hale getirebilmek için, ekranda  ikonu görünene kadar  tuşuna basın.  tuşuna basarak normal sensör moduna geri dönün.

Kolay Erişilebilen Hafıza



Bu işlev, kullanıcıların istedikleri bir programı kontrol ünitesinin kalıcı belleğine kaydetmesine olanak sağlar ve bu kayıt her zaman geri yüklenebilir. Bu yapılan değişiklikleri geçersiz kılmak ve orijinal programa geri dönmek için harika bir yoldur.

Programı Kaydetmek için:

1. Kontrol ünitesinin seçilen bir zaman çizelgesine göre programlandığından emin olun.
2. Rölanli modunda, geçerli programı kaydetmek için  ve  düğmesini beş saniye basılı tutun.
3. Ekranda geçerli programın kalıcı belleğe kaydedildiğini belirten, soldan sağ hareket eden üç kısa çizgi görünür. İşlem tamamlandığında “Done” mesajı ekranda yanıp sönecektir.



Kaydedilmiş programı tekrar yüklemek için:

1. Rölanli modunda,  ve  düğmesini beş saniye basılı tutun.
2. Ekranda istenen programın kalıcı bellekten alındığını belirten, sağdan sola hareket eden üç kısa çizgi görünür.



Kontrol ünitesi geri yüklenen programı mevcut program olarak kabul edecektir. İşlem tamamlandığında “Done” mesajı ekranda yanıp sönecektir.



NOT: Kolay Erişilebilir Hafızayı kullanırken dikkatli olunuz. Kolay erişilebilir belleği kullanarak hafızaya program kaydederken, mevcut kaydetmek istediğiniz program daha önce kaydettiğiniz programın üzerine kaydedecektir. Kayıt yaparken güncel bilgilerin kaydetmek istediğiniz veriler olduğundan emin olun.

Ana Vana Kurulumu (sadece NODE-200, NODE-400, & NODE-600)

Çok istasyonlu NODE modelleri (NODE-200, NODE-400 ve NODE-600), normalde kapalı ana vana kullanılarak programlanabilir. Ana vanayı programlarken, istasyon 1 ana vana olarak atanır ki buda 1 numaralı istasyonun sulama istasyonu olarak kullanılması etkinliğini kaybettirir.

1. Rölanti modunda,  simgesi görüntülenene kadar  düğmesini basın.
2. Sol alt kısımda etkin istasyon numarası ile birlikte Program A görüntülenir. Etkin istasyonun "1" olarak görüldüğünden emin olun .





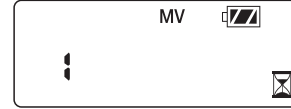

3.  tuşuna bir kere basın ve **MV** (Ana Vana) şekli ekranda görülecektir ve zaman göstergesi kaybolacaktır. İstasyon 1 ana vana olarak aktiftir ve diğer programlama ekranlarında görül-meyecektir.



4. Ana vana aktif edildiğinde tüm programlara uygulanacaktır ve **MV** şekli ekranda her zaman kalacaktır.





Programlanabilir Kapatma (99 güne kadar)

Bu özellik kullanıcıya programlanmış sulama sistemini 1 ile 99 gün arasında durdurma imkanı verir. Programlanabilir kapatma süresi sonrasında program normal çalışma sistemine geri döner.

1. Rölanti modunda,  simgesi görüntülenene kadar  düğmesini basın. **OFF** yazısı ekranda görünene kadar 2 saniye bekleyiniz. Kontrol ünitesi şimdi **OFF-KAPALI** moddadır.
2.  düğmesine bastığınızda yanıp sönen "1" görüntülenecektir. Bu da kontrol ünitesinin kapalı kalacağı gün sayısını belirtir. İsteğinize göre 99 güne kadar kapatma süresini programlayabilirsiniz.
3. Programlanabilir kapatma süresince geri kalan gün sayısı ekranda gösterilecektir.
4. **OFF** (kapalı) dönemine müdahale etmek için günün saatini ve hafta gününü gösteren rölanti modu ekranına geri dönmek üzere  düğmesine basın.







PİL ÖMRÜ GÖSTERGESİ

Kalan pil ömrü, ekranda gösterilen pil ömrü göstergesinden hesaplanabilir. NODE, bir veya iki adet dokuz voltluk pil kullanılarak çalıştırılabilir. İki adet dokuz voltluk pil kullanarak tek bir dokuz voltluk pilin sunacağı pil ömrünü yaklaşık iki katına çıkarabilirsiniz. Aşağıdaki pil ömrü göstergesi, tahmini kalan pil ömrünü gösterir.

-  Dolu: 100-60% kalan pil ömrü
-  Orta: 60-25% kalan pil ömrü
-  Düşük: 25-0% kalan pil ömrü
-  Derhal pili değiştiriniz.

KONTROL ÜNİTESİNİN RESETLENMESİ

Kontrol ünitesinin resetlenmesi esnasında mevcut program silinecek ve kontrol ünitesi tekrardan başlayacaktır. Ancak, resetleme işlemi Kolay Erişilebilir Hafıza özelliği ile kalıcı belleğe kaydedilmiş seçili programı silmeyecektir. (bknz sayfa 12)

1. Rölanti modunda ,  ve  tuşlarını basılı tutun.
2. İki saniye sonra ekran boş olarak gözükecektir. ,  y  tuşlarına basmaya devam ediniz.
3. Ekranda 12.00 yanıp sönmeye başlayacaktır. Tuşlara basmayı bırakınız.
4. Kontrol ünitesi 10 dan 1 e doğru ekranda geri saymaya başlayacak ve işlem tamamlandığında 12:00 AM yanıp sönmeye başlayacaktır. Kontrol ünitesi şimdi tekrardan programlanabilir.

Problem	Nedenler	Çözümler
Ekran Yok.	Ekran kapalı. Pil bitmiş.	Bir saniyeliliğine herhangi bir düğmeye basın. Pili değiştiriniz.
Ekran sulamayı gösteriyor fakat çalışmıyor.	Su basıncı yok. Hatalı solenoid. Uyumsuz solenoid.	Ana sistemi kontrol ediniz. Solenoidi değiştiriniz. Hunter DC Latching Solenoid (P/N 458200) veya diğer uyumlu DC latching solenoidler kullanılmalıdır.
Otomatik sulama başlama zamanında çalışmıyor.	Kontrol Ünitesi Kapalı Sistem/System Off modunda. Gün zamanlaması doğru ayarlanmamış(AM/PM) Başlangıç saati doğru ayarlanmamış.	Kontrol ünitesinin otomatik sulama için doğru programlandığından emin olunuz. Gün zamanlama ayarını düzeltiniz. (AM/PM) Başlangıç saati ayarını düzeltiniz.
Yağmur sensörleri sulamayı ertelemiyor.	Yağmur sensörü zarar görmüş veya yanlış kablolama.	Yağmur sensörünün düzgün çalıştığından ve bağlantıların doğru yapıldığından emin olunuz. (bknz 10)
Kontrol ünitesi birden fazla sulama yapıyor.	Programlarda birden faza atanmış başlangıç zamanı vardır. Her programın dört adede kadar başlangıç zamanı olabilir.	İhtiyacınıza göre başlama zamanlarını elimine edebilirsiniz.

ŞARTNAME

EBATLAR: 3 1/2"(89 mm) çap, 2 1/2"(64 mm) yükseklik

SENSÖR GİRİŞLERİ: Bir

GÜÇ KAYNAĞI: Bir adet dokuz voltluk alkalin pil (daha uzun pil ömrü için iki adet kullanın). 9-11VDC DC latching solenoidleri aktive etmek için (Hunter PN 458200)

ÇALIŞMA SICAKLIĞI: 0°F - 140°F arası veya -17°C - 60°C arası

ONAYLAR:

IP68
CE
FCC
C-Tick

Hunter®

Hunter Industries Incorporated
1940 Diamond Street • San Marcos, California 92078, USA
www.hunterindustries.com/global

© 2018 Hunter Industries Incorporated

LIT-560 C 6/18