

PS ULTRA / PRO-SPRAY[®]

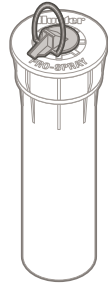

1



2

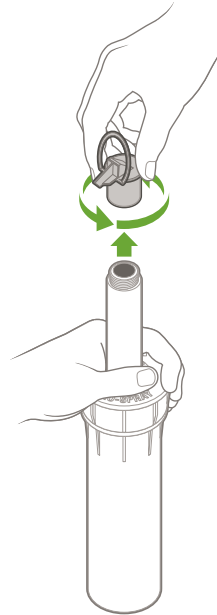

3

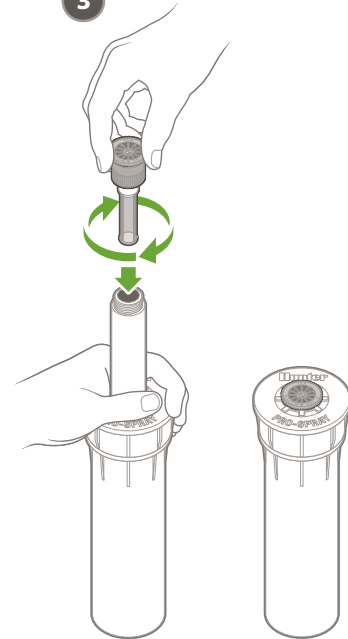

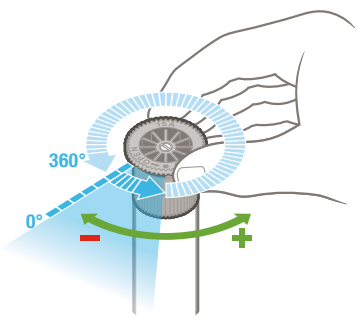
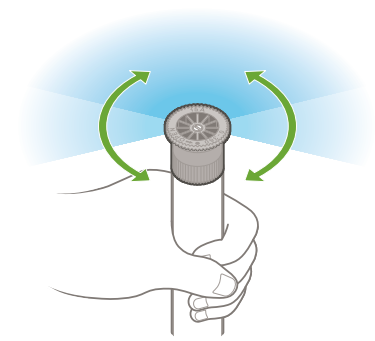
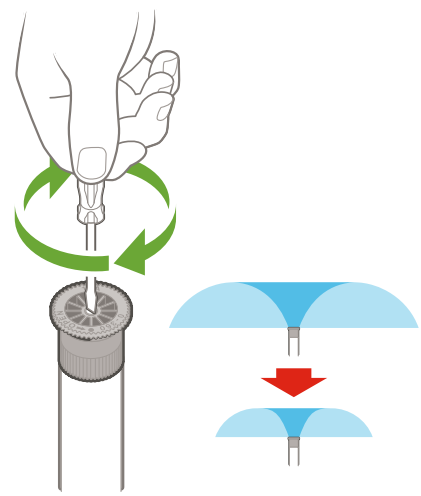
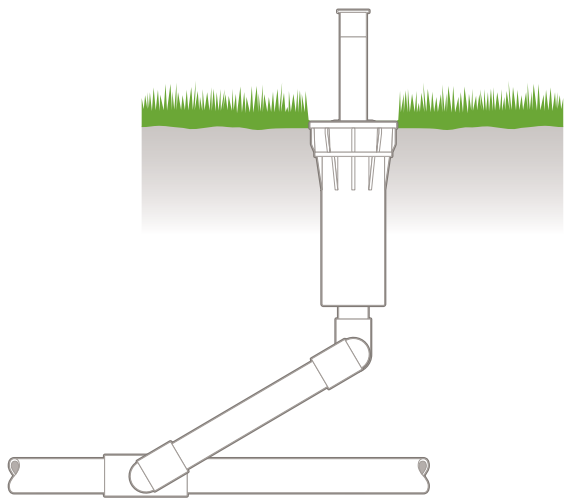



10A



1.0–3.0 Bar
100–300 kPa
20–40 PSI



0.7–9.5 l/m
0.2–2.3 GPM



2.6–3.5 m
(9'–11')



12A



1.0–3.0 Bar
100–300 kPa
20–40 PSI



0.7–13.4 l/m
0.3–3.4 GPM



3.2–4.1 m
(11'–13')



15A



1.0–3.0 Bar
100–300 kPa
20–40 PSI



1.3–18.0 l/m
0.4–4.5 GPM



4.0–5.2 m
(14'–17')



17A



1.0–3.0 Bar
100–300 kPa
20–40 PSI



1.7–21.7 l/m
0.5–5.5 GPM



4.6–5.8 m
(16'–19')