

CLASSIC SERIES

PERISTALTIC METERING PUMPS

INSTALLATION AND MAINTENANCE MANUAL

 WARNING

TO BE INSTALLED AND MAINTAINED BY PROPERLY TRAINED PROFESSIONAL INSTALLER ONLY. READ MANUAL & LABELS FOR ALL SAFETY INFORMATION & INSTRUCTIONS.

TABLE OF CONTENTS

Warranty and Service Policy	3
Safety Information	4-11, 14-16, 19-23, 26, 27, 35
Flow Rate Outputs	6-11
Materials of Construction	12
Accessories	13
Installation.....	14-22
Troubleshooting	23-26
Tube Replacement	27-34
Cleaning the Point of Injection.....	35-37
Motor – Exploded View and Parts.....	38-41
Feed Rate Control – Exploded View and Parts	42-43
Pump Head – Exploded View and Parts	44-46
Pump Tubes	47
Check Valves.....	48
For Your Records	49

IMCL 020223

WARRANTY AND CUSTOMER SERVICE

LIMITED WARRANTY

Stenner Pump Company will for a period of one (1) year from the date of purchase (proof of purchase required) repair or replace, at our option, all defective parts. Stenner is not responsible for any removal or installation costs. Pump tube assemblies and rubber components are considered perishable and are not covered in this warranty. Pump tube will be replaced each time a pump is in for service, unless otherwise specified. The cost of the pump tube replacement will be the responsibility of the customer. Stenner will incur shipping costs for warranty products shipped from our factory in Jacksonville, Florida. Any tampering with major components, chemical damage, faulty wiring, weather conditions, water damage, power surges, or products not used with reasonable care and maintained in accordance with the instructions will void the warranty. Stenner limits its liability solely to the cost of the original product. We make no other warranty expressed or implied.

RETURNS

Stenner offers a 30-day return policy on factory direct purchases. Except as otherwise provided, no merchandise will be accepted for return after 30 days from purchase. To return merchandise at any time, call Stenner at 800.683.2378 for a Return Merchandise Authorization (RMA) number. A 15% re-stocking fee will be applied. Include a copy of your invoice or packing slip with your return.

DAMAGED OR LOST SHIPMENTS

All truck shipments: Check your order immediately upon arrival. All damage must be noted on the delivery receipt. Call Stenner Customer Service at 800.683.2378 for all shortages and damages within seven (7) days of receipt.

SERVICE & REPAIRS

Before returning a pump for warranty or repair, remove chemical from pump tube by running water through the tube, and then run the pump dry. Following expiration of the warranty period, Stenner Pump Company will clean and overhaul any Stenner metering pump for a minimum labor charge plus necessary replacement parts and shipping. All metering pumps received for overhaul will be restored to their original condition. The customer will be charged for missing parts unless specific instructions are given. To return merchandise for repair, call Stenner at 800.683.2378 or 904.641.1666 for a Return Merchandise Authorization (RMA) number.

DISCLAIMER

The information contained in this manual is not intended for specific application purposes. Stenner Pump Company reserves the right to make changes to prices, products, and specifications at any time without prior notice.

TRADEMARKS

QuickPro® is a registered trademark of the Stenner Pump Company.

Santoprene® is a registered trademark of Exxon Mobil Corporation.

Versilon® is a registered trademark of Saint-Gobain Performance Plastics.

Pellethane® is a registered trademark of Lubrizol Advanced Materials, Inc.

AquaShield™ is a trademark of Houghton International.

SAFETY INFORMATION

IMPORTANT SAFETY INSTRUCTIONS

When installing and using this electrical equipment, basic safety precautions should always be followed, including the following:

READ AND FOLLOW ALL INSTRUCTIONS



⚠ WARNING Warns about hazards that **CAN** cause death, serious personal injury, or property damage if ignored.



⚠ WARNING **ELECTRIC SHOCK HAZARD**



⚠ WARNING **ELECTRIC SHOCK HAZARD**

Pump supplied with grounding power cord and attached plug. To reduce risk of electrical shock, connect only to a properly grounded, grounding type receptacle. Install only on a circuit protected by a Ground-Fault Circuit-Interrupter (GFCI).



⚠ AVERTISSEMENT **DANGER DE CHOC ÉLECTRIQUE**

La pompe est dotée d'un cordon d'alimentation avec mise à la terre muni d'une fiche. Pour réduire le risque de choc électrique, branchez uniquement sur une prise correctement mise à la terre. Installez uniquement sur un circuit protégé par un disjoncteur différentiel.



DO NOT alter the power cord or plug end.



DO NOT use receptacle adapters.



DO NOT use pump with a damaged or altered power cord or plug. Contact the factory or an authorized service facility for repair.



⚠ WARNING **HAZARDOUS VOLTAGE**

DISCONNECT power cord before removing motor cover for service. **Electrical service by trained personnel only.**



⚠ WARNING **EXPLOSION HAZARD**

This equipment **IS NOT** explosion proof. **DO NOT** install or operate in an explosive environment.



⚠ WARNING **RISK OF CHEMICAL EXPOSURE**

Potential for chemical burns, fire, explosion, personal injury, or property damage. To reduce risk of exposure, the use of proper personal protective equipment is mandatory.



⚠ WARNING **RISK OF FIRE HAZARD**

DO NOT install or operate on any flammable surface.



⚠ WARNING **RISK OF CHEMICAL OVERDOSE**

To reduce risk, follow proper installation methods and recommendations. Check your local codes for additional guidelines.



⚠ WARNING To reduce the risk of injury, do not permit children to use this product. This appliance is not to be used by persons with reduced physical, sensory or mental capabilities, or lack of experience or knowledge, unless they have been given supervision or instruction.

SAFETY INFORMATION continued



CAUTION Warns about hazards that **WILL** or **CAN** cause minor personal injury or property damage if ignored.









CAUTION PLUMBING

Chemical feed pump installation must always adhere to your local plumbing codes and requirements. Be sure installation does not constitute a cross connection. Check local plumbing codes for guidelines.



NOTICE: Indicates special instructions or general mandatory action.

-  This metering pump is portable and designed to be removable from the plumbing system without damage to the connections.
-  Before installing or servicing the pump, read the pump manual for all safety information and complete instructions. The pump is designed for installation and service by properly trained personnel.
-  Installation of product must adhere to all regulatory and compliance codes applicable to the area.
-  This metering pump and its components have been tested for use with the following chemicals: Sodium Hypochlorite (10-15%), Muriatic Acid (20-22 Baume, 31.5% HCl), and Soda Ash.
-  Cette pompe de dosage et ses composants ont été testés pour leur compatibilité avec les produits chimiques suivants : hypochlorite de sodium (10 à 15 %), acide chlorhydrique (20 à 22 % Baume, 31,5 % HCl), et carbonate de sodium.
-  This metering pump is certified by WQA for use with Water and Sodium Hypochlorite 15%, when using Santoprene® tube material.



This is the safety alert symbol. When displayed in this manual or on the equipment, look for one of the following signal words alerting you to the potential for personal injury or property damage.



PUMP SUITABLE FOR USE OUTDOORS when installed with a Stenner Rain Roof Part No. MP90000.



Electrical installation should adhere to all national and local codes. Consult a licensed professional for assistance with proper electrical installation.



Removing power from pool/spa recirculation pump must also remove power from pump.



The use of an auxiliary safety device (not supplied), such as a flow switch or sensor, is recommended to prevent feed pump operation in the event of a recirculation pump failure or if flow is not sensed.



Point of chemical injection should be beyond all pumps, filters, and heaters.



Suitable for indoor and outdoor use.



Adaptée à une utilisation aussi bien à l'intérieur qu'à l'extérieur.

SAVE THESE INSTRUCTIONS

FLOW RATE OUTPUTS CLASSIC 45

Single Head Adjustable – Gallons per Day

Model	Item Number Prefix	Maximum psi / bar	Pump Tube	Feed Rate Control Setting										
				L	1	2	3	4	5	6	7	8	9	10
45MHP2	45MJH1	100 / 6.9	1	0.2	0.3	0.6	0.9	1.2	1.5	1.8	2.1	2.4	2.7	3.0
45M1	45MJL1	25 / 1.7		0.2	0.3	0.6	0.9	1.2	1.5	1.8	2.1	2.4	2.7	3.0
45MHP10	45MJH2	100 / 6.9	2	0.5	1.0	2.0	3.0	4.0	5.0	6.0	7.0	8.0	9.0	10.0
45M2	45MJL2	25 / 1.7		0.5	1.0	2.0	3.0	4.0	5.0	6.0	7.0	8.0	9.0	10.0
45MHP22	45MJH7	100 / 6.9	7	1.1	2.2	4.4	6.6	8.8	11.0	13.2	15.4	17.6	19.8	22.0
45M3	45MJL3	25 / 1.7	3	1.1	2.2	4.4	6.6	8.8	11.0	13.2	15.4	17.6	19.8	22.0
45M4	45MJL4	25 / 1.7	4	1.7	3.5	7.0	10.5	14.0	17.5	21.0	24.5	28.0	31.5	35.0
45M5	45MJL5	25 / 1.7	5	2.5	5.0	10.0	15.0	20.0	25.0	30.0	35.0	40.0	45.0	50.0

Approximate Outputs @ 60Hz

Single Head Adjustable – Liters per Day

Model	Item Number Prefix	Maximum psi / bar	Pump Tube	Feed Rate Control Setting										
				L	1	2	3	4	5	6	7	8	9	10
45MHP2	45MJH1	100 / 6.9	1	0.6	0.9	1.8	2.7	3.6	4.5	5.5	6.4	7.3	8.2	9.1
45M1	45MJL1	25 / 1.7		0.6	0.9	1.8	2.7	3.6	4.5	5.5	6.4	7.3	8.2	9.1
45MHP10	45MJH2	100 / 6.9	2	1.5	3.0	6.1	9.1	12.1	15.1	18.2	21.2	24.2	27.3	30.3
45M2	45MJL2	25 / 1.7		1.5	3.0	6.1	9.1	12.1	15.1	18.2	21.2	24.2	27.3	30.3
45MHP22	45MJH7	100 / 6.9	7	3.3	6.6	13.3	20.0	26.6	33.3	40.0	46.6	53.3	60.0	66.6
45M3	45MJL3	25 / 1.7	3	3.3	6.6	13.3	20.0	26.6	33.3	40.0	46.6	53.3	60.0	66.6
45M4	45MJL4	25 / 1.7	4	5.1	10.6	21.2	31.8	42.4	53.0	63.6	74.2	84.8	95.4	106.0
45M5	45MJL5	25 / 1.7	5	7.6	15.1	30.3	45.4	60.6	75.7	90.8	106.0	121.1	136.3	151.4

Approximate Outputs @ 50Hz

Single Head Fixed – Gallons & Liters per Day

Model	Item Number Prefix	Maximum psi / bar	Pump Tube	GPD @ 60Hz	LPD @ 50Hz
45MHP2	45MFH1	100 / 6.9	1	3.0	9.1
45MP1	45MFL1	25 / 1.7			
45MHP10	45MFH2	100 / 6.9	2	10.0	30.3
45MP2	45MFL2	25 / 1.7			
45MHP22	45MFH7	100 / 6.9	7	22.0	66.6
45MP3	45MFL3	25 / 1.7			
45MP4	45MLF4	25 / 1.7	4	35.0	106.0
45MP5	45MLF5	25 / 1.7	5	50.0	151.4

Approximate Outputs @ 60 & 50Hz



NOTICE: The information within this chart is solely intended for use as a guide. The output data is an approximation based on pumping water under a controlled testing environment. Many variables can affect the output of the pump. Stenner Pump Company recommends that all metering pumps undergo field calibration by means of analytical testing to confirm their outputs.

FLOW RATE OUTPUTS CLASSIC 85

Single Head Adjustable – Gallons per Day

Model	Item Number Prefix	Maximum psi / bar	Pump Tube	Feed Rate Control Setting										
				L	1	2	3	4	5	6	7	8	9	10
85MHP5	85MJH1	100 / 6.9	1	0.3	0.5	1.0	1.5	2.0	2.5	3.0	3.5	4.0	4.5	5.0
85M1	85MJL1	25 / 1.7		0.3	0.5	1.0	1.5	2.0	2.5	3.0	3.5	4.0	4.5	5.0
85MHP17	85MJH2	100 / 6.9	2	0.8	1.7	3.4	5.1	6.8	8.5	10.2	11.9	13.6	15.3	17.0
85M2	85MJL2	25 / 1.7		0.8	1.7	3.4	5.1	6.8	8.5	10.2	11.9	13.6	15.3	17.0
85MHP40	85MJH7	100 / 6.9	7	2.0	4.0	8.0	12.0	16.0	20.0	24.0	28.0	32.0	36.0	40.0
85M3	85MJL3	25 / 1.7		2.0	4.0	8.0	12.0	16.0	20.0	24.0	28.0	32.0	36.0	40.0
85M4	85MJL4	25 / 1.7	4	3.0	6.0	12.0	18.0	24.0	30.0	36.0	42.0	48.0	54.0	60.0
85M5	85MJL5	25 / 1.7		3.0	6.0	12.0	18.0	24.0	30.0	36.0	42.0	48.0	54.0	60.0
			5	4.3	8.5	17.0	25.5	34.0	42.5	51.0	59.5	68.0	76.5	85.0
				4.3	8.5	17.0	25.5	34.0	42.5	51.0	59.5	68.0	76.5	85.0

Approximate Outputs @ 60Hz

Single Head Adjustable – Liters per Day

Model	Item Number Prefix	Maximum psi / bar	Pump Tube	Feed Rate Control Setting										
				L	1	2	3	4	5	6	7	8	9	10
85MHP5	85MJH1	100 / 6.9	1	0.9	1.5	3.0	4.5	6.1	7.6	9.1	10.6	12.1	13.6	15.1
85M1	85MJL1	25 / 1.7		0.9	1.5	3.0	4.5	6.1	7.6	9.1	10.6	12.1	13.6	15.1
85MHP17	85MJH2	100 / 6.9	2	2.4	5.1	10.3	15.4	20.6	25.7	30.9	36.0	41.2	46.3	51.5
85M2	85MJL2	25 / 1.7		2.4	5.1	10.3	15.4	20.6	25.7	30.9	36.0	41.2	46.3	51.5
85MHP40	85MJH7	100 / 6.9	7	6.1	12.1	24.2	36.3	48.5	60.6	72.7	84.8	96.9	109.0	121.1
85M3	85MJL3	25 / 1.7		6.1	12.1	24.2	36.3	48.5	60.6	72.7	84.8	96.9	109.0	121.1
85M4	85MJL4	25 / 1.7	4	9.1	18.2	36.3	54.5	72.7	90.8	109.0	127.2	145.3	163.5	181.7
85M5	85MJL5	25 / 1.7		9.1	18.2	36.3	54.5	72.7	90.8	109.0	127.2	145.3	163.5	181.7
			5	13.0	25.7	51.5	77.2	103.0	128.7	154.4	180.0	205.9	231.6	257.4
				13.0	25.7	51.5	77.2	103.0	128.7	154.4	180.0	205.9	231.6	257.4

Approximate Outputs @ 50Hz

Single Head Fixed – Gallons & Liters per Day

Model	Item Number Prefix	Maximum psi / bar	Pump Tube	GPD @ 60Hz	LPD @ 50Hz
85MPHP5	85MFH1	100 / 6.9	1	5.0	15.1
85MP1	85MFL1	25 / 1.7			
85MPHP17	85MFH2	100 / 6.9	2	17.0	51.5
85MP2	85MFL2	25 / 1.7			
85MPHP40	85MFH7	100 / 6.9	7	40.0	121.1
85MP3	85MFL3	25 / 1.7			
85MP4	85MFL4	25 / 1.7	4	60.0	181.7
85MP5	85MFL5	25 / 1.7	5	85.0	257.4

Approximate Outputs @ 60 & 50Hz



NOTICE: The information within this chart is solely intended for use as a guide. The output data is an approximation based on pumping water under a controlled testing environment. Many variables can affect the output of the pump. Stenner Pump Company recommends that all metering pumps undergo field calibration by means of analytical testing to confirm their outputs.

FLOW RATE OUTPUTS CLASSIC 100

Double Head Adjustable – Gallons per Day

Model	Item Number Prefix	Maximum psi / bar	Pump Tube	Feed Rate Control Setting										
				L	1	2	3	4	5	6	7	8	9	10
100DMHP5	100JH1	100 / 6.9	1	0.3	0.6	1.2	1.8	2.4	3.0	3.6	4.2	4.8	5.4	6.0
100DM1	100JL1	25 / 1.7		0.3	0.6	1.2	1.8	2.4	3.0	3.6	4.2	4.8	5.4	6.0
100DMHP20	100JH2	100 / 6.9	2	1.0	2.0	4.0	6.0	8.0	10.0	12.0	14.0	16.0	18.0	20.0
100DM2	100JL2	25 / 1.7		1.0	2.0	4.0	6.0	8.0	10.0	12.0	14.0	16.0	18.0	20.0
100DM3	100JL3	25 / 1.7	3	2.2	4.4	8.8	13.2	17.6	22.0	26.4	30.8	35.2	39.6	44.0
100DM4	100JL4	25 / 1.7	4	3.5	7.0	14.0	21.0	28.0	35.0	42.0	49.0	56.0	63.0	70.0
100DM5	100JL5	25 / 1.7	5	5.0	10.0	20.0	30.0	40.0	50.0	60.0	70.0	80.0	90.0	100.0

Approximate Outputs @ 60Hz

Double Head Adjustable – Liters per Day

Model	Item Number Prefix	Maximum psi / bar	Pump Tube	Feed Rate Control Setting										
				L	1	2	3	4	5	6	7	8	9	10
100DMHP5	100JH1	100 / 6.9	1	0.9	1.8	3.6	5.5	7.3	9.1	10.9	12.7	14.5	16.4	18.2
100DM1	100JL1	25 / 1.7		0.9	1.8	3.6	5.5	7.3	9.1	10.9	12.7	14.5	16.4	18.2
100DMHP20	100JH2	100 / 6.9	2	3.0	6.1	12.1	18.2	24.2	30.3	36.4	42.4	48.5	54.5	60.6
100DM2	100JL2	25 / 1.7		3.0	6.1	12.1	18.2	24.2	30.3	36.4	42.4	48.5	54.5	60.6
100DM3	100JL3	25 / 1.7	3	6.7	13.3	26.7	40.0	53.3	66.6	79.9	93.3	106.6	119.9	133.2
100DM4	100JL4	25 / 1.7	4	10.6	21.2	42.4	63.6	84.8	106.0	127.2	148.4	169.6	190.8	212.0
100DM5	100JL5	25 / 1.7	5	15.1	30.3	60.6	90.8	121.1	151.4	181.7	212.0	242.2	272.5	302.8

Approximate Outputs @ 50Hz

Double Head Fixed – Gallons & Liters per Day

Model	Item Number Prefix	Maximum psi / bar	Pump Tube	GPD @ 60Hz	LPD @ 50Hz
100DMHP5	100FH1	100 / 6.9	1	6.0	18.2
100DMP1	100FL1	25 / 1.7			
100DMHP20	100FH2	100 / 6.9	2	20.0	60.6
100DMP2	100FL2	25 / 1.7			
100DMP3	100FL3	25 / 1.7	3	44.0	133.2
100DMP4	100FL4	25 / 1.7	4	70.0	212.0
100DMP5	100FL5	25 / 1.7	5	100.0	302.8

Approximate Outputs @ 60 & 50Hz



NOTICE: The information within this chart is solely intended for use as a guide. The output data is an approximation based on pumping water under a controlled testing environment. Many variables can affect the output of the pump. Stenner Pump Company recommends that all metering pumps undergo field calibration by means of analytical testing to confirm their outputs.

FLOW RATE OUTPUTS CLASSIC 170

Double Head Adjustable – Gallons per Day

Model	Item Number Prefix	Maximum psi / bar	Pump Tube	Feed Rate Control Setting													
				L	1	2	3	4	5	6	7	8	9	10			
170DMHP9	170JH1	100 / 6.9	1	0.5	1.0	2.0	3.0	4.0	5.0	6.0	7.0	8.0	9.0	10.0			
170DM1	170JL1	25 / 1.7		170DMHP34	170JH2	100 / 6.9	2	1.7	3.4	6.0	9.5	13.6	17.0	20.4	23.8	27.2	30.6
170DM2	170JL2	25 / 1.7	170DM3	170JL3	25 / 1.7	3		4.0	8.0	16.0	24.0	32.0	40.0	48.0	56.0	64.0	72.0
170DM4	170JL4	25 / 1.7	4	6.0	12.0	24.0	36.0	48.0	60.0	72.0	84.0	96.0	108.0	120.0			
170DM5	170JL5	25 / 1.7	5	8.5	17.0	34.0	51.0	68.0	85.0	102.0	119.0	136.0	153.0	170.0			

Approximate Outputs @ 60Hz

Double Head Adjustable – Liters per Day

Model	Item Number Prefix	Maximum psi / bar	Pump Tube	Feed Rate Control Setting													
				L	1	2	3	4	5	6	7	8	9	10			
170DMHP9	170JH1	100 / 6.9	1	1.5	3.0	6.1	9.1	12.1	15.1	18.2	21.2	24.2	27.3	30.3			
170DM1	170JL1	25 / 1.7		170DMHP34	170JH2	100 / 6.9	2	5.1	10.3	18.2	28.8	39.1	51.5	61.8	72.1	82.4	92.7
170DM2	170JL2	25 / 1.7	170DM3	170JL3	25 / 1.7	3		12.1	24.2	48.5	72.7	96.9	121.1	145.4	169.6	193.8	218.0
170DM4	170JL4	25 / 1.7	4	18.2	36.3	72.7	109.0	145.3	181.7	218.0	254.4	290.7	327.0	363.4			
170DM5	170JL5	25 / 1.7	5	25.7	51.5	86.0	154.4	205.9	257.4	308.9	360.4	411.8	463.3	514.8			

Approximate Outputs @ 50Hz

Double Head Fixed – Gallons & Liters per Day

Model	Item Number Prefix	Maximum psi / bar	Pump Tube	GPD @ 60Hz	LPD @ 50Hz
170DMHP9	170FH1	100 / 6.9	1	10.0	30.3
170DM1	170FL1	25 / 1.7			
170DMHP34	170FH2	100 / 6.9	2	34.0	102.6
170DM2	170FL2	25 / 1.7			
170DM3	170FL3	25 / 1.7	3	80.0	242.2
170DM4	170FL4	25 / 1.7	4	120.0	363.4
170DM5	170FL5	25 / 1.7	5	170.0	514.8

Approximate Outputs @ 60 & 50Hz



NOTICE: The information within this chart is solely intended for use as a guide. The output data is an approximation based on pumping water under a controlled testing environment. Many variables can affect the output of the pump. Stenner Pump Company recommends that all metering pumps undergo field calibration by means of analytical testing to confirm their outputs.

FLOW RATE OUTPUTS CLASSIC 100 *DUAL CONTROL*

DETERMINE FLOW RATE OUTPUTS FOR EACH PUMP HEAD

Use the innermost pump head flow rate outputs to determine the output for each pump head. Both feed rate controls (FRC) on setting 10 = maximum flow rate capacity of the pump.

Innermost Pump Head

L=5%, 1-10 = approx. 10% of maximum innermost output

Outermost Pump Head

Outermost Output = (Outermost FRC Setting %) x (Innermost Output)

Example

100MDC5 with Innermost FRC setting on 4

1. Innermost FRC setting 4 = 20 GPD
2. If outermost FRC is set on 3, then outermost output is 30% of innermost output; 0.3 x 20 GPD = 6 GPD
3. Outermost = 6 GPD, Innermost = 20 GPD, Total Pump Output = 26 GPD

Innermost Pump Head – Gallons per Day

Model	Item Number Prefix	Maximum psi / bar	Pump Tube	Feed Rate Control Setting										
				L	1	2	3	4	5	6	7	8	9	10
100MDCHP5	100DH1	100 / 6.9	1	0.2	0.3	0.6	0.9	1.2	1.5	1.8	2.1	2.4	2.7	3.0
100MDC1	100DL1	25 / 1.7		0.5	1.0	2.0	3.0	4.0	5.0	6.0	7.0	8.0	9.0	10.0
100MDCHP20	100DH2	100 / 6.9	2	1.1	2.2	4.4	6.6	8.8	11.0	13.2	15.4	17.6	19.8	22.0
100MDC2	100DL2	25 / 1.7		1.7	3.5	7.0	10.5	14.0	17.5	21.0	24.5	28.0	31.5	35.0
100MDC3	100DL3	25 / 1.7	3	2.5	5.0	10.0	15.0	20.0	25.0	30.0	35.0	40.0	45.0	50.0
100MDC4	100DL4	25 / 1.7	4											
100MDC5	100DL5	25 / 1.7	5											

Approximate Outputs @ 60Hz

Innermost Pump Head – Liters per Day

Model	Item Number Prefix	Maximum psi / bar	Pump Tube	Feed Rate Control Setting										
				L	1	2	3	4	5	6	7	8	9	10
100MDCHP5	100DH1	100 / 6.9	1	0.6	0.9	1.8	2.7	3.6	4.5	5.5	6.4	7.3	8.2	9.1
100MDC1	100DL1	25 / 1.7		1.5	3.0	6.1	9.1	12.1	15.1	18.2	21.2	24.2	27.3	30.3
100MDCHP20	100DH2	100 / 6.9	2	3.3	6.6	13.3	20.0	26.6	33.3	40.0	46.6	53.3	60.0	66.6
100MDC2	100DL2	25 / 1.7		5.1	10.6	21.2	31.8	42.4	53.0	63.6	74.2	84.8	95.4	106.0
100MDC3	100DL3	25 / 1.7	3	7.6	15.1	30.3	45.4	60.6	75.7	90.8	106.0	121.1	136.3	151.4
100MDC4	100DL4	25 / 1.7	4											
100MDC5	100DL5	25 / 1.7	5											

Approximate Outputs @ 50Hz



NOTICE: The information within this chart is solely intended for use as a guide. The output data is an approximation based on pumping water under a controlled testing environment. Many variables can affect the output of the pump. Stenner Pump Company recommends that all metering pumps undergo field calibration by means of analytical testing to confirm their outputs.

FLOW RATE OUTPUTS CLASSIC 170 *DUAL CONTROL*

Innermost Pump Head – Gallons per Day

Model	Item Number Prefix	Maximum psi / bar	Pump Tube	Feed Rate Control Setting										
				L	1	2	3	4	5	6	7	8	9	1
170MDCHP9	170DH1	100 / 6.9	1	0.3	0.5	1.0	1.5	2.0	2.5	3.0	3.5	4.0	4.5	5.0
170MDC1	170DL1	25 / 1.7		0.3	0.5	1.0	1.5	2.0	2.5	3.0	3.5	4.0	4.5	5.0
170MDCHP34	170DH2	100 / 6.9	2	0.8	1.7	3.4	5.1	6.8	8.5	10.2	11.9	13.6	15.3	17.0
170MDC2	170DL2	25 / 1.7		0.8	1.7	3.4	5.1	6.8	8.5	10.2	11.9	13.6	15.3	17.0
170MDC3	170DL3	25 / 1.7	3	2.0	4.0	8.0	12.0	16.0	20.0	24.0	28.0	32.0	36.0	40.0
170MDC4	170DL4	25 / 1.7	4	3.0	6.0	12.0	18.0	24.0	30.0	36.0	42.0	48.0	54.0	60.0
170MDC5	170DL5	25 / 1.7	5	4.3	8.5	17.0	25.5	34.0	42.5	51.0	59.5	68.0	76.5	85.0

Approximate Outputs @ 60Hz

Innermost Pump Head – Liters per Day

Model	Item Number Prefix	Maximum psi / bar	Pump Tube	Feed Rate Control Setting										
				L	1	2	3	4	5	6	7	8	9	10
170MDCHP9	170DH1	100 / 6.9	1	0.9	1.5	3.0	4.5	6.1	7.6	9.1	10.6	12.1	13.6	15.1
170MDC1	170DL1	25 / 1.7		0.9	1.5	3.0	4.5	6.1	7.6	9.1	10.6	12.1	13.6	15.1
170MDCHP34	170DH2	100 / 6.9	2	2.4	5.1	10.3	15.4	20.6	25.7	30.9	36.0	41.2	46.3	51.5
170MDC2	170DL2	25 / 1.7		2.4	5.1	10.3	15.4	20.6	25.7	30.9	36.0	41.2	46.3	51.5
170MDC3	170DL3	25 / 1.7	3	6.1	12.1	24.2	36.3	48.5	60.6	72.7	84.8	96.9	109.0	121.1
170MDC4	170DL4	25 / 1.7	4	9.1	18.2	36.3	54.5	72.7	90.8	109.0	127.2	145.3	163.5	181.7
170MDC5	170DL5	25 / 1.7	5	13.0	25.7	51.5	77.2	103.0	128.7	154.4	180.0	205.9	231.6	257.4

Approximate Outputs @ 50Hz



NOTICE: The information within this chart is solely intended for use as a guide. The output data is an approximation based on pumping water under a controlled testing environment. Many variables can affect the output of the pump. Stenner Pump Company recommends that all metering pumps undergo field calibration by means of analytical testing to confirm their outputs.

MATERIALS OF CONSTRUCTION

All Housings

Polycarbonate

Pump Tube

Santoprene® (FDA approved) or Versilon®

Check Valve Duckbill

Santoprene® (FDA approved) or Pellethane®

Suction/Discharge Tubing & Ferrules

Polyethylene (FDA approved)

Suction Line Strainer and Cap

PVC or Polypropylene (both NSF listed); ceramic weight

All Fasteners

Stainless Steel

Tube and Injection Fittings

PVC or Polypropylene (both NSF listed)

Connecting Nuts and 3/8" Adapter

PVC or Polypropylene (both NSF listed)

Pump Head Latches

Polypropylene

ACCESSORIES

3 Connecting nuts 1/4" & 3 Ferrules 1/4" or 6 mm *Europe*
or 3 Connecting Nuts & 2 Adapters 3/8"

1 Injection Fitting 25 psi (1.7 bar) max.
or 1 Duckbill Check Valve 100 psi (6.9 bar) max. or

1 Weighted Suction Line Strainer 1/4", 3/8" or 6 mm *Europe*

20' Roll of Suction/Discharge Tubing 1/4" or 3/8" white or UV black
or 20' Roll of Suction/Discharge Tubing, white, 6 mm *Europe*

1 Additional Pump Tube

2 Additional Latches

1 Mounting Bracket

1 Manual

* Double head pumps include an additional set of the accessories listed above.

INSTALLATION

ADDITIONAL SAFETY INSTRUCTIONS

! **NOTICE:** Indicates special instructions or general mandatory action.

- !** Read all safety hazards before installing or servicing the pump. The pump is designed for installation and service by properly trained personnel.
- !** Use all required personal protective equipment when working on or near a chemical metering pump.
- !** Install the pump so that it is in compliance with all national and local plumbing and electrical codes.
- !** Use the proper product to treat potable water systems, use only chemicals listed or approved for use.
- !** Install the pump to work in conjunction with pool, spa, well pump, or system controls.
- !** Inspect tube frequently for leakage, deterioration, or wear. Schedule a regular pump tube maintenance change to prevent chemical damage to pump and/or spillage.
- !** Mount pump vertically and use spill recovery to run chemical back to tank in the event of tube failure. Not recommended for acid applications.
- !** To reduce risk, follow proper installation methods and recommendations. Check your local codes for additional guidelines.
- !** Pump is not recommended for installation in areas where leakage can cause personal injury or property damage.

INSTALLATION continued

MOUNT PUMP

- ❗ Select a dry location (to avoid water intrusion and pump damage) above the solution tank. Best recommended location is above the solution tank in a vertical position with the pump head pointed downward and the spill recovery (see page 18) in place to reduce the risk and severity of damage. Spill recovery not recommended for acid applications.
 - ❗ To prevent pump damage in the event of a pump tube leak, never mount the pump vertically with the pump head up.
 - ❗ To avoid chemical damage from fumes, DO NOT mount pump directly over an open solution tank. Keep tank covered.
 - ❗ Avoid flooded suction or pump mounted lower than the solution container. Draw solution from the top of the tank. Pump can run dry without damage. If pump is installed with a flooded suction, a shut-off valve or other device must be provided to stop flow to pump during service.
1. Use the mounting bracket as a template to drill pilot holes in mounting location.
 2. Secure bracket with fasteners or wall anchors. Slide pump into bracket.
- ❗ Provide 8" clearance to allow pump orientation to be reversed during tube replacement. DO NOT allow water intrusion into the motor or corrosion and damage will occur.
 - ❗ To prevent motor damage, verify with a volt meter that the receptacle voltage corresponds with the pump voltage.
3. Plug cord into receptacle and turn the motor power switch on. If the pump is adjustable, turn the dial ring to 10.
 4. Activate the pump by the pump control (flow switch, pressure switch, etc.) and verify rotation of the roller assembly within the clear pump head. Turn pump switch off.

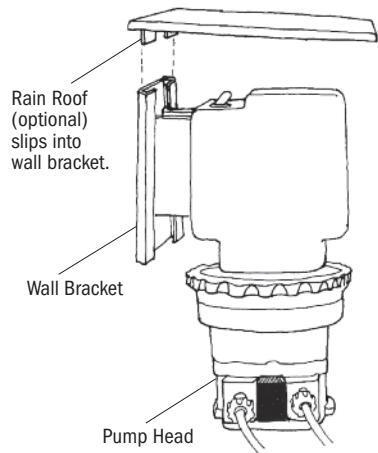

INSTALLATION continued

ADDITIONAL INSTRUCTIONS FOR CE PUMPS WHEN APPLICABLE

ADDITIONAL INSTALLATION INSTRUCTIONS

1. All Class II Pumps located in Zone 1 of swimming pool areas require locating where flooding cannot occur.
 2. This pump is intended to be installed as “fixed” as opposed to portable.
 3. The Rain Roof must be installed and “vertical orientation” mounting of entire unit observed.
 4. After installation, the power supply plug must be accessible during use.
 5. This unit must be scrapped if the supply cord is damaged.
 6. Observe and comply with all National Wiring Standards.
-

ZUSTÄZLICHE INSTALLIERUNGSANWEISUNGEN

1. Pumpen die sich in Zone 1 vom Schwimmbecken befinden sollen sind so einzurichten daß Ueberschwemmungen nicht vorkommen werden.
 2. Diese Pumpe ist als fest montierte Ausrüstung bedacht und soll nicht umstellbar gebraucht werden.
 3. Der Regendach muss installiert werden. Eine vertikale Asrichtung der Montage muß erzielt werden.
 4. Die Stromversorgung muss nach der Installation noch zugänglich sein.
 5. Bei beschadigter Verkabelung ist dieses Gerat nicht mehr zu gebrauchen.
 6. Staatliche Vernetzungsvorchriften müssen eingehalten werden.
-

INSTRUCTIONS SUPPLÉMENTAIRES D'INSTALLATION

1. Toutes les pompes installées dans la Zone 1 du périmètre de la piscine doivent être situées de manière à ne pas pouvoir être inondées.
 2. Cette pompe est prévue pour installation fixe et non pas portative.
 3. L'abri anti-pluie doit être installé et l'orientation verticale doit toujours être observée.
 4. Après l'installation, la prise électrique doit rester accessible pendant l'utilisation.
 5. Cette unité doit être mise au rebut si le cordon électrique est endommagé.
 6. Observez et adhérez à toutes les Normes Nationales pour Installations Electriques.
-

INSTRUCCIONES ADICIONALES PARA INSTALACION

1. Todas las bombas Clase II situadas en la Zona 1 de las áreas de la piscina requieren colocarse donde no puedan ser inundadas.
 2. Esta bomba es para ser instalada “fija” en vez de portátil.
 3. Es necesario instalar el techo de lluvia, y montar la unidad entera siguiendo una orientación vertical.
 4. Después de la instalación el enchufe suministrador de energía debe estar accesible durante el uso.
 5. Se deberá deshechar la unidad si el cordón de abastecimiento se deteriora.
 6. Observe y cumpla con todas las Reglas Nacionales para Instalaciones Eléctricas.
-

ISTRUZIONI SUPPLEMENTARI PER L' INSTALLAZIONE

1. Tutte le pompe Classe II localizzate nella Zona 1 della superficie circostante la piscina devono essere collocate dove gli allagamenti no possono accadere.
2. Questa pompa, é inteso, deve essere installata come ‘fissa’ e non come portatile.
3. La tettoia deve essere installata e il montaggio ‘orientazione verticale’ dell’intera unità deve essere osservato.
4. Dopo l’installazione, la spina deve essere accessibile durante l’uso.
5. Questa unità deve essere gettata via se il filo elettrico é danneggiato.
6. Osservare e aderire a tutte le Norme Nazionali Sugli Impianti Elettrici.

INSTALLATION DIAGRAM

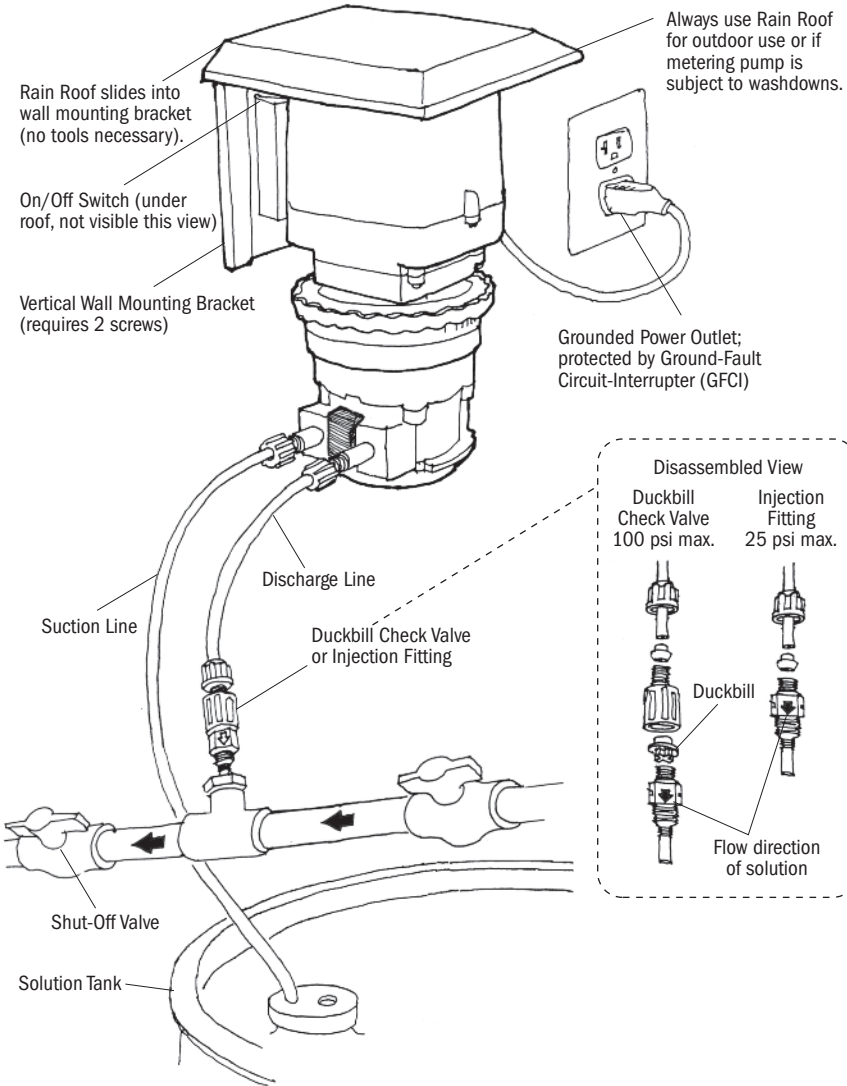

INSTALLATION continued

SPILL RECOVERY

Mount the pump vertically and use the spill recovery to drain chemical back to the tank in the event of tube failure. This will help prevent chemical from collecting in the tube housing and reduces spillage on the floor. To reduce risk, follow proper installation methods and recommendations. Check your local codes for additional guidelines.

The pump motor is ventilated and water intrusion can cause motor damage. A rain roof is recommended for outdoor and wet environments.

SPILL RECOVERY IS NOT RECOMMENDED FOR ACID APPLICATIONS.

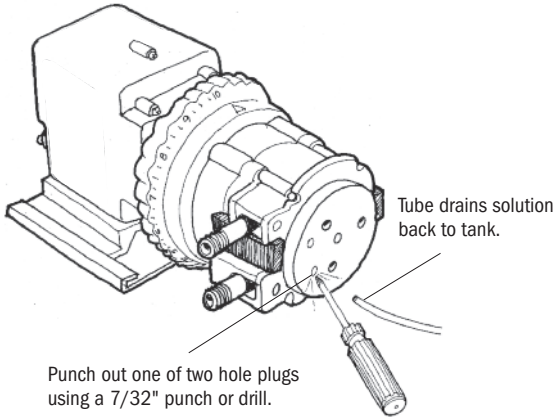

Punch out one of two hole plugs using a 7/32" punch or drill.

Use section of 1/4" suction/discharge tubing and insert in hole.

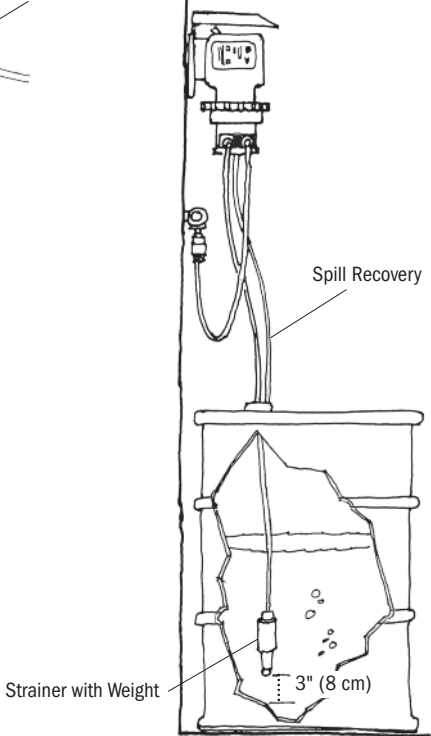

INSTALLATION continued

INSTALL SUCTION LINE TO PUMP HEAD

1. Uncoil the suction/discharge tubing. Use outside of solution tank as a guide to cut proper length of suction line ensuring it will be 2-3" above the bottom of solution tank.



Allow sufficient slack to avoid kinks and stress cracks. Always make a clean square cut to assure that the suction line is burr free. Normal maintenance requires trimming.



Suction lines that extend to the bottom of the tank can result in debris pickup leading to clogged injectors and possible tube failure.

2. Make connections

1/4" Slide the line(s) through the 1/4" connecting nut and ferrule.

3/8" Finger tighten the 3/8" adapter onto the tube fitting then slide the line(s) through the 3/8" connecting nut.

3. Tighten connections

1/4" While firmly holding the tube fitting, finger tighten nut to the threaded tube fitting.

3/8" While firmly holding the 3/8" adapter, finger tighten nut to the adapter.

Then wrench tighten one additional half turn. If leak occurs, gradually tighten the 3/8" connecting nut as required.



Over tightening the ferrule and nut may result in damaged fittings, crushed ferrules, and air pick up.



DO NOT use thread seal tape on pump tube connections.

More on next page

Connecting Nut Assembly

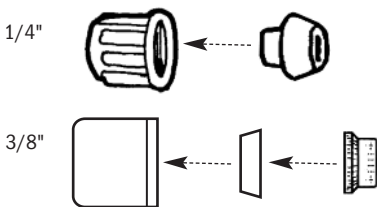

DO NOT use thread seal tape on pump tube threads.

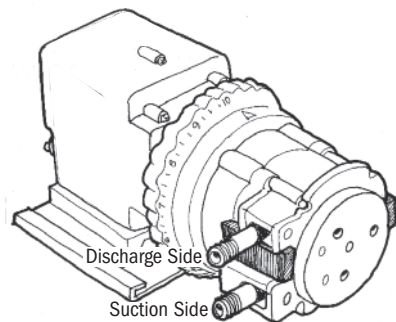

NOTE: Tubing should bottom into all fittings.

INSTALLATION continued

INSTALL SUCTION WEIGHT TO SUCTION LINE

1. Drill a hole into the bung cap or solution tank lid. Slide the tubing through and secure the weighted strainer to the line.
2. To attach the strainer, push approximately 3.5" of suction line through the cap on the strainer body. Pull tubing to make sure it is secure.
3. Suspend approximately 3" above tank bottom to reduce the chance of sediment pickup.



DO NOT mix chemicals in the solution container. Follow recommended mixing procedures according to the manufacturer.



DO NOT operate pump unless chemical is completely in solution. Turn pump off when replenishing solution.



DO NOT slide tubing all the way to the bottom of the weighted strainer. Tubing could become flush with the nose of the strainer and the pump may not prime due to blockage.

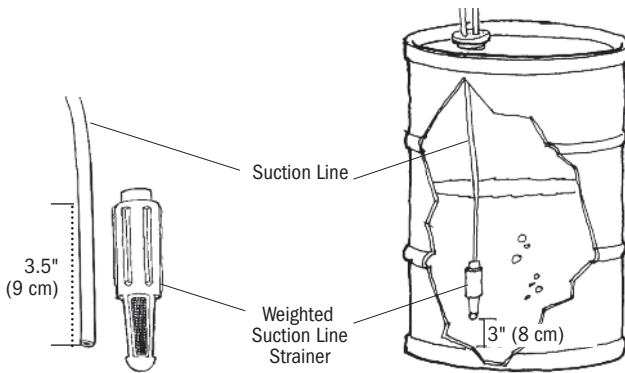

INSTALLATION continued

INSTALL DISCHARGE LINE TO PUMP HEAD AND INJECTION POINT

1. Make a secure finger tight connection on the discharge fitting of the pump head as instructed in Install Suction Line instructions.



DO NOT use thread seal tape on pump tube connections.



⚠ WARNING HAZARDOUS PRESSURE: Shut off water or circulation system and bleed off any system pressure.



Locate a point of injection beyond all pumps and filters or as determined by the application.

2. A 1/4" or 1/2" Female NPT (FNPT) connection is required for installing the injection fitting. If there is no FNPT fitting available, provide one by either tapping the pipe or installing FNPT pipe tee fitting.
3. Wrap the Male NPT (MNPT) end of injection fitting with 2 or 3 turns of thread seal tape. If necessary, trim the injection fitting quill as required to inject product directly into flow of water.

More on next page

DO NOT use thread seal tape on pump tube threads.

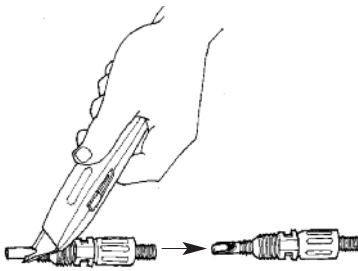

Trim Injection Fitting

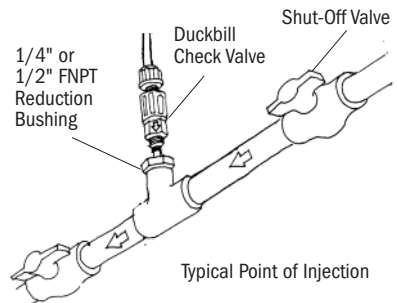

INSTALLATION continued

- Hand tighten the injection fitting into the FNPT fitting.

Injection Fitting

- Install connecting nut and ferrule to the pump discharge line. Insert discharge line into injection fitting until it reaches base of fitting.
- Finger tighten connecting nut to fitting. For 3/8" connections wrench tighten one additional 1/2 turn. If leak occurs, gradually tighten the 3/8" connecting nut as required.

Duckbill Check Valve

- Prior to connection, test check valve and NPT threads for leaks by pressurizing system. If necessary, tighten an additional 1/4 turn.
 - Install connecting nut and ferrule to the pump discharge line. Insert discharge line into check valve body until it reaches base of body.
 - Finger tighten connecting nut to fitting. For 3/8" connections wrench tighten one additional 1/2 turn. If leak occurs, gradually tighten the 3/8" connecting nut as required.
- Turn pump on and re-pressurize system. Observe chemical flow as actuated by system and check all connections for leaks.
 - After suitable amount of dosing time, perform tests for desired chemical readings (e.g., pH or ppm). If necessary, fine tune dosing levels by rotating dial ring (adjustable pumps only) or by adjusting solution strength.



The injection point and fitting require periodic maintenance to clean any deposits or buildup. To allow quick access to the point of injection, Stenner recommends the installation of shut-off valves.

TROUBLESHOOTING MOTOR

 **WARNING** HAZARDOUS VOLTAGE

DISCONNECT power cord before removing motor cover for service. **Electrical service should be performed by trained personnel only.**

PROBLEM	POSSIBLE CAUSE	SOLUTION
Loud or excessive noise	Worn ball bearings Damaged bearing brackets or tolerance rings Insufficient gear lubrication Worn gears or gear posts	Replace rotor assembly Replace bearing brackets and tolerance rings Apply AquaShield™ to gears and gear posts Inspect and/or replace gears and gear posts
Motor does not work; fan does not turn	Faulty electrical supply Bearing brackets broken Damaged motor coil Worn or damaged rotor bearings Damaged power cord Rotor bound or rusted to coil Faulty wire connections Obstructed fan	Check electrical supply Replace bearing brackets Replace motor coil Replace rotor assembly Inspect and/or replace power cord Buff off coil and rotor or replace Inspect and/or repair electrical connections Remove obstruction
Motor runs; fan turns, output shaft does not	Worn or damaged gears	Replace gears as needed
Motor overheats and shuts off and on	Incorrect voltage High ambient temperature Damaged/malfunctioning coil	Check voltage and frequency matches pump label Pumps are rated to 125 °F (51 °C) maximum Replace motor coil
Phenolic gear is stripping	Water intrusion Cracked bearing bracket Worn gear posts Rusted helical gear at end of rotor Worn or cracked gear case cover Missing phenolic gear spacer Insufficient lubrication	Use rain roof, replace phenolic gear & all affected components Replace bearing bracket & phenolic gear Replace gear posts & affected gears Buff off rotor or replace rotor, replace phenolic gear Replace gear case or gear case cover Replace phenolic gear and install spacer on top of gear Apply AquaShield™ to gears and gear posts

TROUBLESHOOTING FEED RATE CONTROL

PROBLEM	POSSIBLE CAUSE	SOLUTION
Dial ring will not turn	Seized or broken variable cam Seized dial ring	Apply Aquashield™ to variable cam & cam slot in feed rate control housing Clean then lubricate dial ring & cam slot with AquaShield™
Dial ring turns, output doesn't change	Variable cam disengaged from dial ring Broken variable cam	Re-insert 90° end into ring Replace variable cam
Pump head does not rotate	Worn index plate Motor problem Pump head roller assembly stripped Index pin holder loose Index pin broken	Turn over or replace index plate Refer to motor troubleshooting Replace roller assembly Tighten holder into spider assembly Replace index pin and lifter assembly
Pump head rotates continuously	Variable cam out of place or worn	Replace or re-insert variable cam
Ratcheting sound	Index plate worn Variable cam worn Lifter worn	Turn over or replace index plate Replace variable cam Replace lifter or complete index pin assembly

TROUBLESHOOTING PUMP HEAD

PROBLEM	POSSIBLE CAUSE	SOLUTION
Roller Assembly will not expand or collapse with tube housing cover	Motor not locked Stripped or cracked roller assembly hub	Fixed Rate Pumps: Place tube housing latch into motor slot; Adjustable Rate Pumps: Set feed rate control to 10 Replace roller assembly
Components cracking	Chemical attack Chemical intrusion from tube failure	Check chemical compatibility Identify and correct cause, clean components of chemical & replace tube according to manual
Pump head leaking	Pump tube rupture	Identify and correct cause, clean components of chemical & replace tube according to manual
No pump output, pump head rotates	Roller assembly not fully expanded Depleted or weighted strainer is above solution tank Leak in the suction line or at connections Ferrules installed incorrectly, missing or damaged Sleeve and/or plastic gripper inside 3/8" connecting nut is missing, damaged, or incorrectly assembled Injection point is clogged Clogged suction and/or discharge line and/or check valve Life of pump tube exhausted Suction line is flush with the nose of the weighted strainer	Expand roller assembly using pump head cover as a tool, according to manual Replenish solution and position suction line 3" above bottom of tank Inspect or replace suction line and/or connections Replace ferrules, beveled end faces pump Replace if damaged or missing. Reorient if incorrectly assembled; gripper beveled end faces nut; sleeve wide end faces gripper Inspect and clean injection point Clean and/or replace as needed Replace tube according to manual, schedule tube replacement based on application Pull suction line approximately 1" from bottom of strainer, cut bottom of suction at an angle
Low pump output, pump head rotates	Life of pump tube exhausted Rollers worn or broken Injection point is restricted Incorrect tube size or setting High system back pressure	Replace tube according to manual, schedule tube replacement based on application Replace roller assembly Inspect and clean injection point regularly Refer to pump output chart and determine dial ring setting or replace tube & ferrules Verify system pressure against tube psi, replace tube and ferrules
No pump output, pump head doesn't rotate	Stripped or cracked roller assembly hub Feed rate control problem Motor problem	Replace roller assembly Refer to feed rate control troubleshooting Refer to motor troubleshooting
Pump output high	Incorrect tube size or setting Roller assembly broken Malfunctioning feed rate control Incorrect motor rpm	Refer to pump output chart and determine dial ring setting or replace tube and ferrules Replace roller assembly Refer to feed rate control troubleshooting Replace with motor that matches pump model







TROUBLESHOOTING PUMP TUBE

NOTICE: A leaking pump tube damages the metering pump. Inspect pump frequently for leakage and wear. Refer to Tube Replacement section for additional safety precautions and instructions.

PROBLEM	POSSIBLE CAUSE	SOLUTION
Tube leaking	Pump tube ruptured	Identify and correct cause, clean components of chemical & replace tube according to manual
	Calcium or mineral deposits	Clean injection fitting; replace tube and duckbill according to manual
	Excessive back pressure	Verify system pressure against tube psi, replace tube and ferrules
	Tube is twisted	Replace tube and ferrules according to manual, hold tube fitting while tightening connecting nut to prevent twisting
	Tube not centered	Clean components of chemical, replace tube and ferrules according to manual & confirm tube is centered
Tube life is shortened	Chemical attack	Check chemical compatibility
	Mineral deposits at injection point	Clean injection fitting. Replace tube, ferrules & duckbill according to manual
	Sediment blockage at check valve	Clean injection fitting, ensure suction line is 3" above tank bottom. Use suction line strainer.
	Degraded check valve duckbill	Replace duckbill. At every tube change, replace duckbill & ferrules.
	Duckbill in wrong orientation	Reverse duckbill orientation
	Seized rollers caused abrasion on tube	Clean roller assembly or replace, do not lubricate
Exposure to heat or sun	Do not store tubes in high temperatures or in direct sunlight	
Tube connection is leaking	Ferrules installed incorrectly, missing or damaged	Replace ferrule, beveled end faces pump
	3/8" nut loose	Firmly hold adapter and finger tighten nut. Wrench tighten additional 1/2 turn.
	Missing ferrule in 3/8" adapter	Insert new ferrule into adapter or replace adapter fitting
	Sleeve and/or plastic gripper inside 3/8" connecting nut is missing, damaged, or incorrectly assembled	Replace if damaged or missing; Reorient if incorrectly assembled; gripper beveled end faces nut; sleeve wider end faces gripper

TUBE REPLACEMENT



WARNING RISK OF CHEMICAL EXPOSURE

-  To reduce risk of exposure, check the pump tube regularly for leakage. At the first sign of leakage, replace the pump tube.
-  To reduce risk of exposure, the use of proper personal protective equipment is mandatory when working on or near chemical metering pumps.
-  To reduce risk of exposure, and also prior to service, shipping, or storage, pump generous amounts of water or a compatible buffer solution to remove chemical from pump.
-  Consult chemical manufacturer and SDS sheet for additional information and precautions for the chemical in use.
-  Personnel should be skilled and trained in the proper safety and handling of the chemicals in use.
-  Inspect tube frequently for leakage, deterioration, or wear. Schedule a regular pump tube maintenance change to prevent chemical damage to pump and/or spillage.





CAUTION PINCH POINT HAZARD

-  Use extreme caution when replacing pump tube. Be careful of your fingers and DO NOT place fingers near rollers.

WARNING HAZARDOUS PRESSURE/CHEMICAL EXPOSURE

-  Use caution and bleed off all resident system pressure prior to attempting service or installation.
-  Use caution when disconnecting discharge line from pump. Discharge may be under pressure. Discharge line may contain chemical.

NOTICE: Indicates special instructions or general mandatory action.

-  **DO NOT** apply grease, oil, or lubricants to the pump tube or housing.
-  Prior to pump tube replacement, inspect the entire pump head for cracks or damaged components. Ensure rollers turn freely.
-  Rinse off chemical residue and clean all chemical and debris from pump head components prior to tube replacement. Apply Aquashield™ to main shaft and tube housing cover bushing during tube replacement.
-  **DO NOT** pull excessively on pump tube. Avoid kinks or damage during tube installation.
-  Inspect the suction and discharge lines, injection point (into pipe), and check valve duckbill for blockages after any tube rupture. Clear or replace as required.

TUBE REPLACEMENT SINGLE HEAD PUMPS

PREPARATION

1. Follow all safety precautions prior to tube replacement.
2. Prior to service, pump water or a compatible buffer solution through the pump and suction and discharge lines to remove chemical and avoid contact.

More on next page

TUBE REPLACEMENT SINGLE HEAD PUMPS continued

REMOVE THE PUMP TUBE

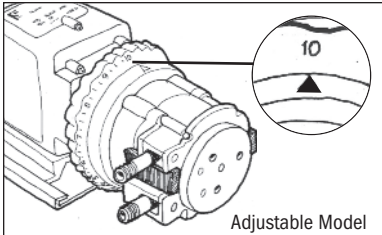

A Adjustable model must be on setting 10

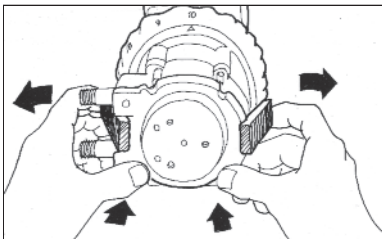

B Open latches

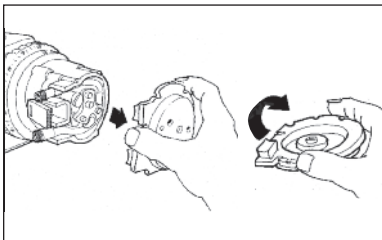

C Remove and invert cover

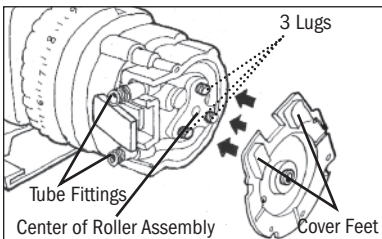

D Align cover feet near tube fittings

1. Turn the pump off and unplug the power cord. On the adjustable model, ensure that the feed rate control is set to 10.

Illustration A

2. Depressurize and disconnect the suction and discharge lines.
3. Open the latches on both sides of the head. *Illustration B*
For CE pump only: Remove the safety screw on cover.
4. Remove the tube housing cover and flip to use as a tool in the next step. *Illustration C*
5. Position the cover feet at 10 o'clock. Align the cover holes with the knurled lugs on the roller assembly. *Illustration D*
NOTE: The roller assembly must be collapsed to remove the tube.

More on next page

TUBE REPLACEMENT SINGLE HEAD PUMPS continued

REMOVE THE PUMP TUBE continued

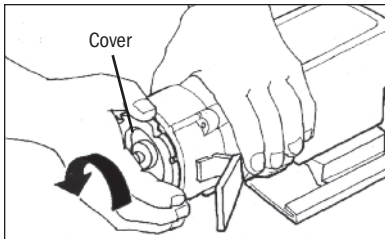

E Collapse roller assembly

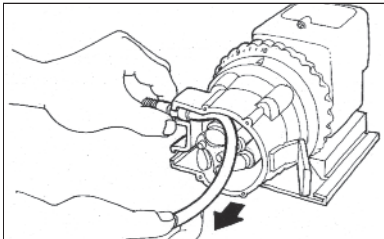

F Remove tube

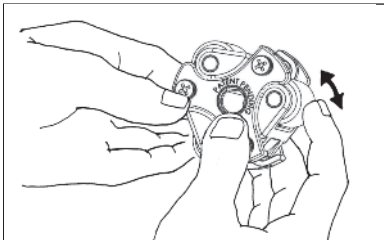

G Check rollers

- 6.** On the adjustable pump, hold the feed rate control securely. On the fixed output pump hold the motor securely. Use the tube cover and quickly snap counterclockwise to collapse the roller assembly. The tube will no longer be pressed against the tube housing wall. *Illustration E*
- 7.** Remove and discard the pump tube. *Illustration F*
- 8.** Remove the roller assembly and housing. On the adjustable pump also remove the shaft. Set them aside to reinstall later.
- 9.** Use a non-citrus all-purpose cleaner to clean chemical residue from the tube housing, roller assembly and cover.
- 10.** Check the housing, cover and roller assembly for cracks. Replace if cracked.
- 11.** Ensure the rollers turn freely. Replace the roller assembly if the rollers are seized or worn or if there is a reduction or lack of output from the pump. *Illustration G*
- 12.** Reinstall the clean tube housing. On an adjustable pump, also install the shaft into the feed rate control.
- 13.** Apply AquaShield™ to the shaft tip.
- 14.** Install the roller assembly.

More on next page

TUBE REPLACEMENT SINGLE HEAD PUMPS continued

INSTALL THE TUBE/EXPAND THE ROLLER ASSEMBLY

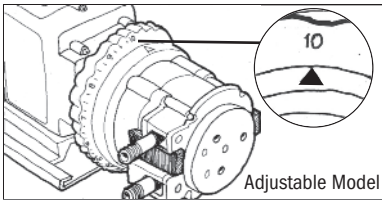

H Adjustable model must be on setting 10

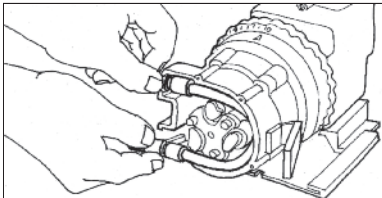

I Place new tube

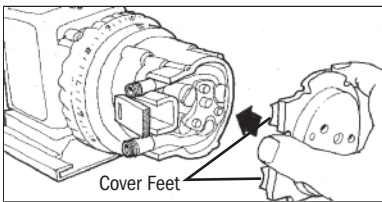

J Install cover feet first

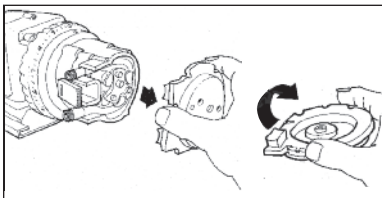

K Remove and invert cover

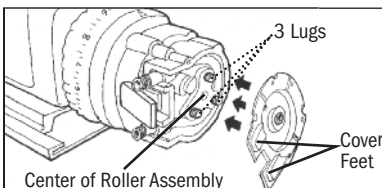

L Align cover feet near the bottom

1. Ensure the power to the pump is off and the power cord is unplugged. On the adjustable model, ensure that the feed rate control is set to 10. *Illustration H*
2. Place the new tube in the pump head and use your fingers to center it on the rollers. *Illustration I*
3. Place the tube housing cover (feet first) on the tube housing, affix the front of the latches to the cover lip and then press the latches back to secure. Be sure the cover is seated with the sleeve bearing on the shaft and is flush with the housing before latching. *Illustration J*
4. With the cover latched, plug the pump in and turn the power on. Allow the pump to run the roller assembly in its collapsed position for approximately 2 to 4 minutes to relax the tube.
5. Turn the pump off and unplug the power cord.
6. Remove the tube housing cover and flip to use as a tool in the next step. *Illustration K*
7. Position the cover feet near the tube fittings. Align the cover holes with the knurled lugs on the roller assembly. *Illustration L*

More on next page

TUBE REPLACEMENT SINGLE HEAD PUMPS continued

INSTALL THE TUBE/EXPAND THE ROLLER ASSEMBLY continued

IMPORTANT: THE ROLLER ASSEMBLY MUST BE EXPANDED so the tube is pressed against the tube housing wall.

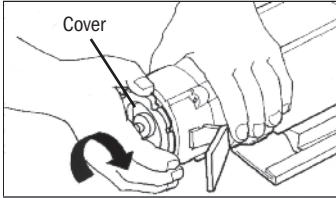

M Expand roller assembly

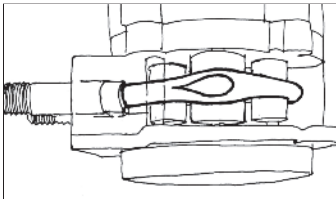

N Confirm roller assembly is expanded

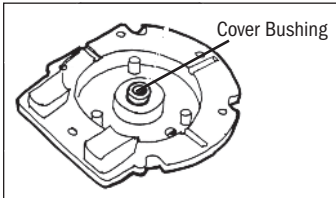

O Apply Aquashield™ to cover bushing

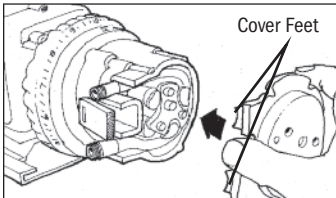

P Install cover feet first

8. Expand roller assembly.

Adjustable Models

Hold the feed rate control securely, use the cover and gently rotate the roller assembly clockwise to expand the roller assembly. The tube will be pressed against the tube housing wall.

Illustrations M & N

Proceed to step 9.

Fixed Output Models (motor vent with key slot, manufactured after 04/29/11)

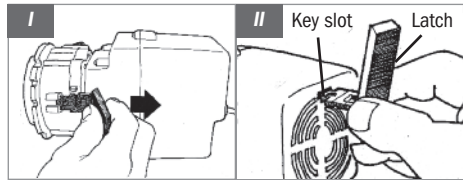

- a. Slide one latch out to remove it from the tube housing. Insert the latch end into the key slot in the vent in the rear of the motor housing.

Illustrations I & II

- b. While pressing the latch into the rear of the motor, hold the motor securely, use the cover and gently rotate the roller assembly clockwise to expand the roller assembly. The tube will be pressed against the tube housing wall. *Illustrations M & N*

- c. Re-attach latch to the tube housing.

Proceed to step 9.

More on next page

TUBE REPLACEMENT SINGLE HEAD PUMPS continued

INSTALL THE TUBE/EXPAND THE ROLLER ASSEMBLY continued

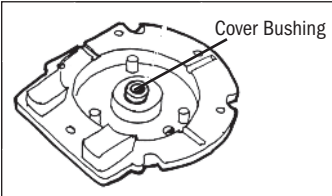

O Apply Aquashield™ to cover bushing

9. Apply a small amount of AquaShield™ to the cover bushing **ONLY**. **DO NOT** lubricate the pump tube. *Illustration O*

10. Place the tube housing cover (feet first) on the tube housing, affix the front of the latches to the cover lip and then press the latches back to secure. Be sure the cover is seated with the sleeve bearing on the shaft and is flush with the housing, before latching. *Illustration P*

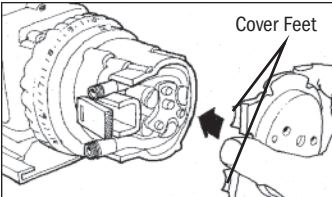

P Install cover feet first

More on next page

TUBE REPLACEMENT SINGLE HEAD PUMPS continued

CENTER THE TUBE

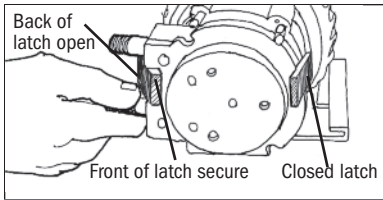

Q Prepare to center tube

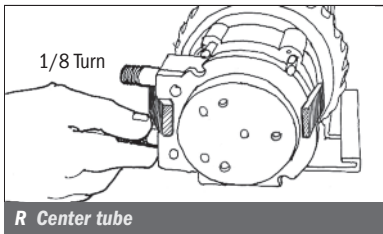

R Center tube

1. Ensure the pump is off. Lift the latch located between the tube fittings, leaving the end of the latch engaged with the lip on the tube housing cover. Leave the latch on the opposite side closed. *Illustration Q*
2. Plug the pump in and turn it on. Turn the tube fitting on the suction side not more than 1/8 of a turn in the direction the tube must move. *Illustration R*
3. **DO NOT** let go of the fitting until the tube rides approximately in center of the rollers.
4. Turn the pump off, let go of the fitting, and secure the latch between the fittings. *For CE pump only: Reinstall the safety screw on the cover.*
5. Inspect the suction and discharge lines, point of injection, and check valve duckbill for blockages. Clean all deposits and/or replace parts as required and always replace ferrules. Failure to do so may lead to poor pump performance, including shortened tube life.
6. Reconnect the suction and discharge lines. **DO NOT** allow the tube fittings to turn inside the pump housing.
7. Turn the pump on and run for two minutes to verify operation.

CLEANING THE POINT OF INJECTION

NOTICE: Indicates special instructions or general mandatory action.

Pumps rated 25 psi maximum are installed with an injection fitting and pumps rated 100 psi maximum are installed with a duckbill check valve. Both allow the extension tip to be installed in the center of the pipe directly in the flow of water to help reduce deposit accumulation.

WARNING Warns about hazards that CAN cause death, serious personal injury, or property damage if ignored.

This is the safety alert symbol. When displayed in this manual or on the equipment, look for one of the following signal words alerting you to the potential for personal injury or property damage.

WARNING HAZARDOUS PRESSURE/CHEMICAL EXPOSURE

- Use caution and bleed off all resident system pressure prior to attempting service or installation.
- Use caution when disconnecting discharge line from pump. Discharge line may be under pressure. Discharge line may contain chemical.
- To reduce risk of exposure, the use of proper personal protective equipment is mandatory when working on or near chemical metering pumps.

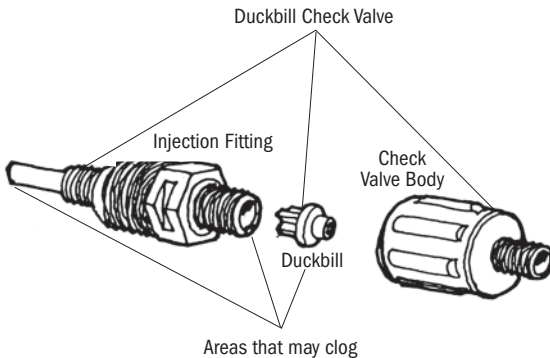

CLEANING THE POINT OF INJECTION continued

1. Turn metering pump off and unplug cord. Disable water pump or auxiliary equipment electrical supply.
2. Depressurize system and bleed pressure from pump discharge line.
3. Loosen and remove connecting nut and ferrule from the check valve or injection fitting to disconnect discharge tubing.

Duckbill Check Valve, go to 4.

Injection Fitting, skip 4 and go to 5.

4.
 - Unscrew the top fitting (check valve body) to disassemble. The bottom fitting (injection fitting with arrow) should remain attached to the pipe.
 - Remove duckbill from check valve body and replace it.
 - Examine o-ring in the injection fitting and replace if deteriorated or damaged.
5. Insert a #2 Phillips head screwdriver through injection fitting into the pipe to locate or break up accumulated deposits. If screwdriver cannot be inserted, drill the deposit out of the injection fitting (DO NOT drill through the opposite pipe wall).

More on next page

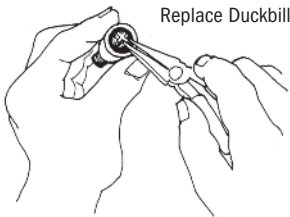

Clean out accumulated deposits with a #2 Phillips head screwdriver.

Periodic inspection and cleaning of the point of injection will maintain proper pump operation and provide maximum tube life.

CLEANING THE POINT OF INJECTION continued

6. Replace discharge line if cracked or deteriorated. If the end is clogged, cut off the calcified or blocked section of discharge line.
7. **Duckbill Check Valve**
 - a. Reassemble the duckbill check valve.
 - b. Replace ferrule and reinstall the discharge line to the check valve approximately 3/4" until it stops.
- Injection Fitting**

Replace ferrule and reinstall the discharge line to the injection fitting approximately 3/4" until it stops.
8. Tighten the connecting nut finger tight.
9. Enable the water pump electrical supply and pressurize the water system.
NOTE: The roller assembly needs to be expanded so the tube is pressed against the tube housing wall.
10. Put the metering pump back in service and inspect all connections for leaks.

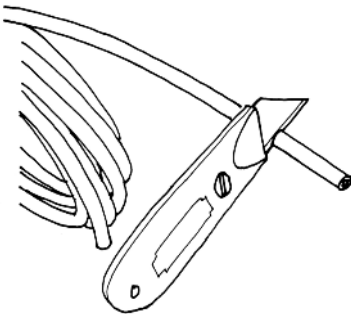

Cut off the calcified or blocked section.

MOTOR EXPLODED VIEW

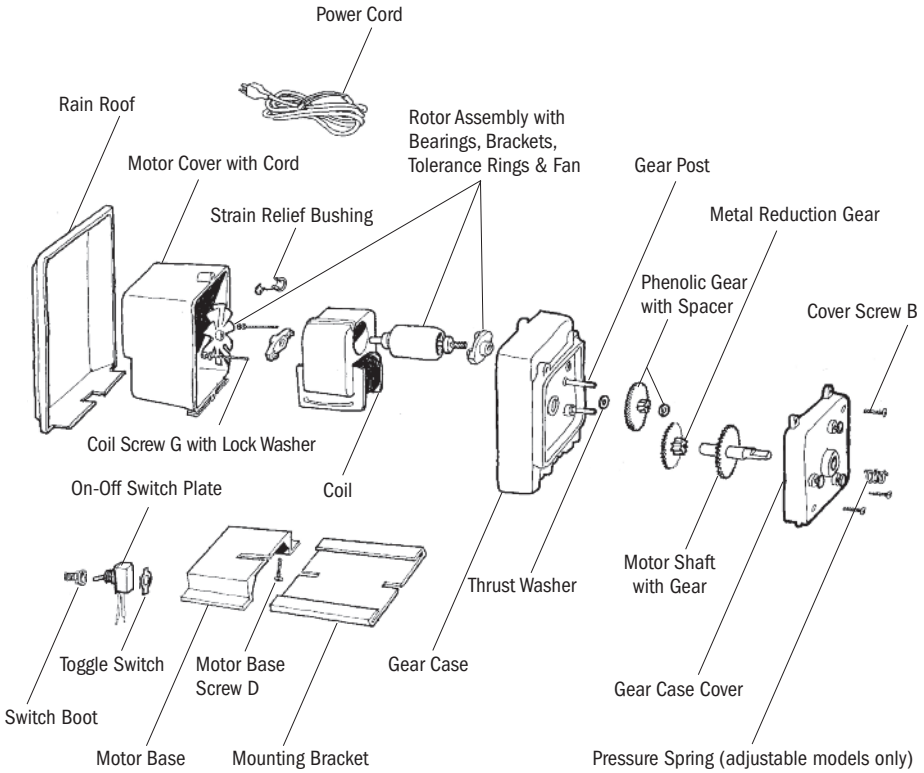

Contact factory for part numbers.

MOTOR 60Hz

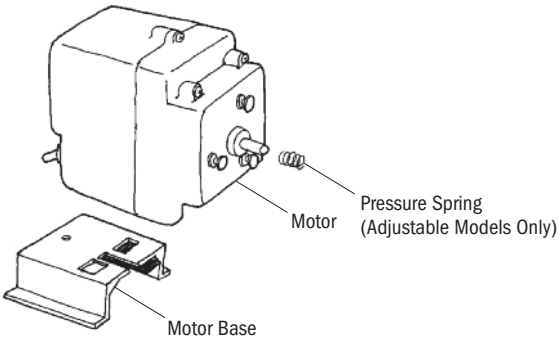

MOTOR 60Hz

DESCRIPTION	WORKS WITH	PART NUMBER	UM
120V	Classic Adjustable 45, 100	PM6041D	EA
220V		PM6042D	EA
120V	Classic Adjustable 85, 170	PM6081D	EA
220V		PM6082D	EA
120V	Classic Fixed 45	ME6041D	EA
220V		ME6042D	EA
120V	Classic Fixed 85	ME6081D	EA
220V		ME6082D	EA
120V	Classic Fixed 100	DM6041D	EA
220V		DM6042D	EA
120V	Classic Fixed 170	DM6081D	EA
220V		DM6082D	EA

MOTOR 50Hz *International*

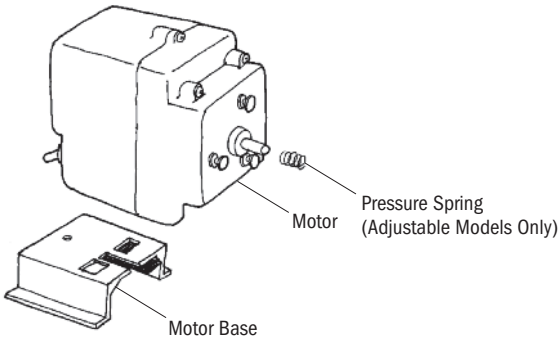

MOTOR 50Hz *International*

DESCRIPTION	WORKS WITH	PART NUMBER	UM
230V	Classic Adjustable 45, 100	PM64230	EA
250V		PM6426D	EA
230V	Classic Adjustable 85, 170	PM68230	EA
250V		PM6826D	EA
230V	Classic Fixed 45	ME64230	EA
250V		ME6426D	EA
230V	Classic Fixed 85	ME68230	EA
250V		ME6826D	EA
230V	Classic Fixed 100	DM64230	EA
250V		DM64250	EA
230V	Classic Fixed 170	DM68230	EA
250V		DM68250	EA

MOTOR SERVICE KITS

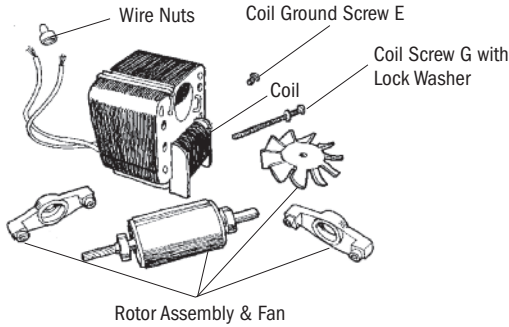

MOTOR SERVICE KIT 60HZ

DESCRIPTION	PART NUMBER	UM
120V	MSK120	KIT
220V	MSK220	KIT

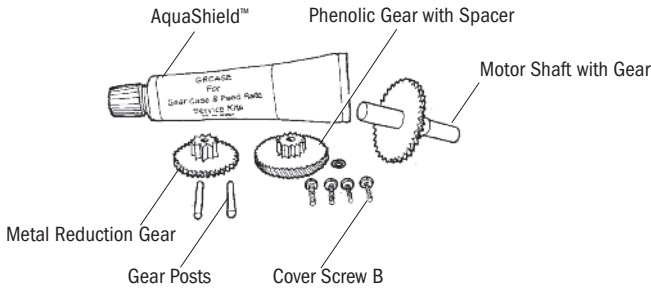

GEAR CASE SERVICE KIT

WORKS WITH	PART NUMBER	UM
Classic Adjustable 45, 100	GSK45A	KIT
Classic Adjustable 85, 170	GSK85A	KIT
Classic Fixed 45	GSK45F	KIT
Classic Fixed 85	GSK85F	KIT

FEED RATE CONTROL EXPLODED VIEW

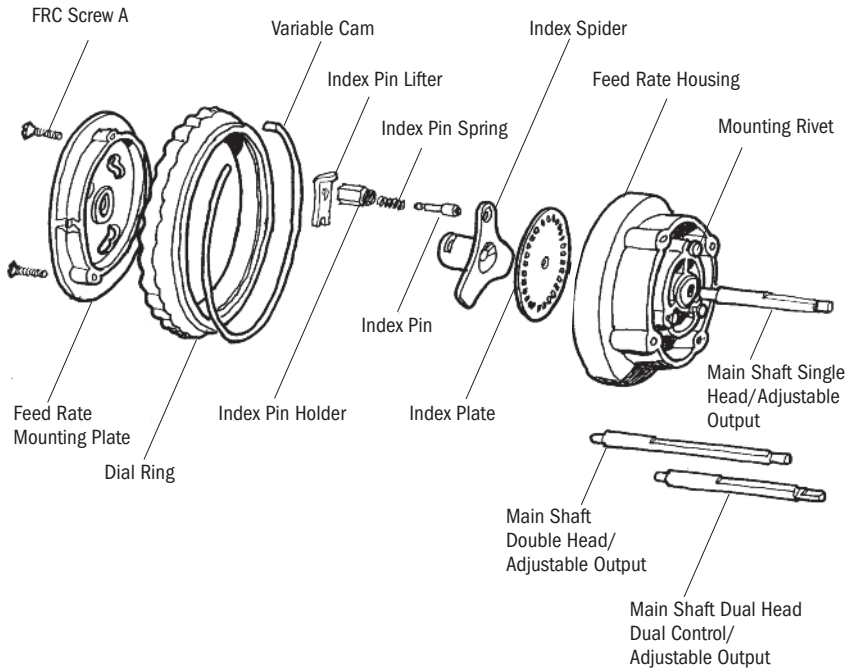

Contact factory for part numbers.

FEED RATE CONTROL AND SERVICE KIT

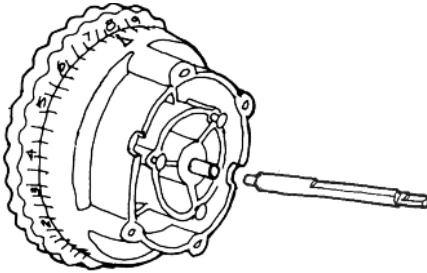

FEED RATE CONTROL WITH SHAFT

WORKS WITH	PART NUMBER	UM
Classic Adjustable 45, 85	FC5040D	EA
Classic Adjustable 100, 170	DM5040D	EA
Classic Dual Control 100, 170	DM504DC	EA

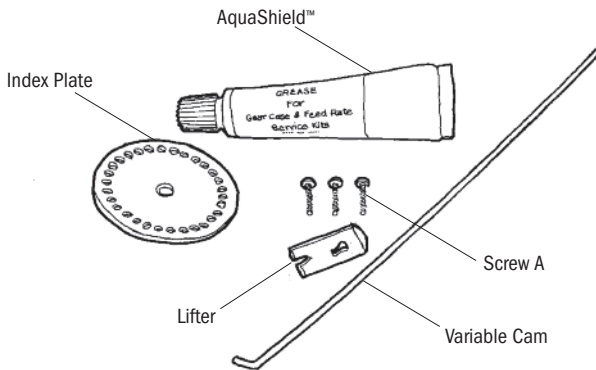

FEED RATE CONTROL SERVICE KIT

WORKS WITH	PART NUMBER	UM
Classic Adjustable 45, 85, 100, 170	FSK100	KIT

PUMP HEAD EXPLODED VIEW

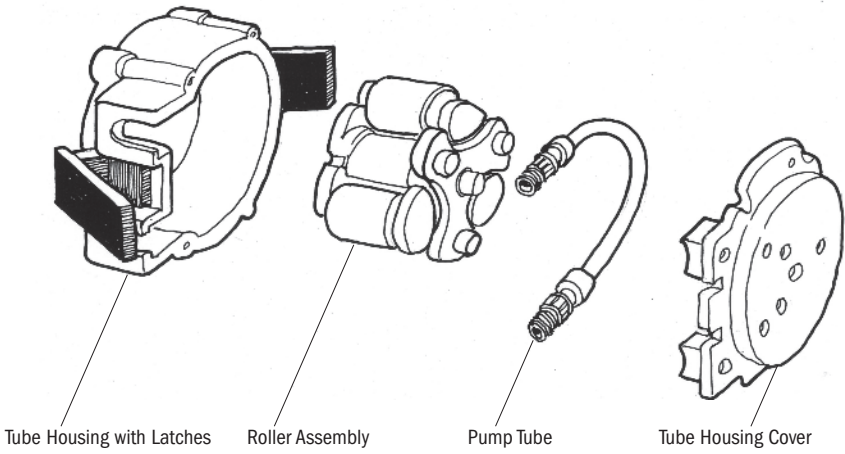

PUMP HEAD PARTS

DESCRIPTION	EA	2-PK	4-PK
Tube Housing & Latches	QP400-1	QP400-2	————
Latches	————	QP401-2	————
Roller Assembly	QP500-1	————	QP500-4
Tube Housing Cover & Bushing	QP100-1	————	QP100-4

PUMP HEAD

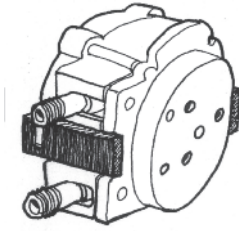

Refer to the **FLOW RATE OUTPUT** chart to match the pump with the correct tube

PUMP HEAD 25 psi max.

Includes tube, ferrules 1/4"

DESCRIPTION	EA	2-PK
#1 Santoprene® QP Pump Head	QP251-1	QP251-2
#2 Santoprene® QP Pump Head	QP252-1	QP252-2
#3 Santoprene® QP Pump Head	QP253-1	QP253-2
#4 Santoprene® QP Pump Head	QP254-1	QP254-2
#5 Santoprene® QP Pump Head	QP255-1	QP255-2
#1 Versilon® QP Pump Head	QP25T1-1	-----
#2 Versilon® QP Pump Head	QP25T2-1	-----
#3 Versilon® QP Pump Head	QP25T3-1	-----
#4 Versilon® QP Pump Head	QP25T4-1	-----
#5 Versilon® QP Pump Head	QP25T5-1	-----

PUMP HEAD 100 psi max.

Includes tube, duckbill, ferrules 1/4"

DESCRIPTION	EA
#1 Santoprene® QP Pump Head	QP101-1
#2 Santoprene® QP Pump Head	QP102-1
#7 Santoprene® QP Pump Head (excludes Classic 100 or 170)	QP107-1
#1 Versilon® QP Pump Head	QP10T1-1
#2 Versilon® QP Pump Head	QP10T2-1

PUMP HEAD 1.7 bar max. EUROPE

Includes tube, ferrules 6 mm

DESCRIPTION	EA	2-PK
#1 Santoprene® QP Pump Head	QP171-1	QP171-2
#2 Santoprene® QP Pump Head	QP172-1	QP172-2
#3 Santoprene® QP Pump Head	QP173-1	QP173-2
#4 Santoprene® QP Pump Head	QP174-1	QP174-2
#5 Santoprene® QP Pump Head	QP175-1	QP175-2
#1 Versilon® QP Pump Head	QP17T1-1	-----
#2 Versilon® QP Pump Head	QP17T2-1	-----
#3 Versilon® QP Pump Head	QP17T3-1	-----
#4 Versilon® QP Pump Head	QP17T4-1	-----
#5 Versilon® QP Pump Head	QP17T5-1	-----

PUMP HEAD 6.9 bar max. EUROPE

Includes tube, duckbill, ferrules 6 mm

DESCRIPTION	EA
#1 Santoprene® QP Pump Head	QP691-1
#2 Santoprene® QP Pump Head	QP692-1
#7 Santoprene® QP Pump Head (excludes Classic 100 or 170)	QP697-1
#1 Versilon® QP Pump Head	QP69T1-1
#2 Versilon® QP Pump Head	QP69T2-1

NOTE: Confirm chemical compatibility with the chemical resistance guide in the catalog.

PUMP HEAD SERVICE KITS

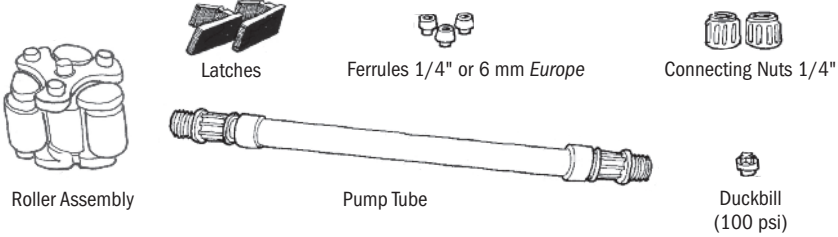

PUMP HEAD SERVICE KIT 25 psi max.

Includes roller assembly, tube, nuts, ferrules 1/4", latches

DESCRIPTION	KIT
#1 Santoprene® QP Kit	QP251K
#2 Santoprene® QP Kit	QP252K
#3 Santoprene® QP Kit	QP253K
#4 Santoprene® QP Kit	QP254K
#5 Santoprene® QP Kit	QP255K
#1 Versilon® QP Kit	QP25T1K
#2 Versilon® QP Kit	QP25T2K
#3 Versilon® QP Kit	QP25T3K
#4 Versilon® QP Kit	QP25T4K
#5 Versilon® QP Kit	QP25T5K

PUMP HEAD SERVICE KIT 100 psi max.

Includes roller assembly, tube, duckbill, nuts, ferrules 1/4", latches

DESCRIPTION	KIT
#1 Santoprene® QP Kit	QP101K
#2 Santoprene® QP Kit	QP102K
#7 Santoprene® QP Kit	QP107K
#1 Versilon® QP Kit	QP10T1K
#2 Versilon® QP Kit	QP10T2K

PUMP HEAD SERVICE KIT 1.7 bar max. EUROPE

Includes roller assembly, tube, nuts, ferrules 6 mm, latches

DESCRIPTION	KIT
#1 Santoprene® QP Kit	QP171K
#2 Santoprene® QP Kit	QP172K
#3 Santoprene® QP Kit	QP173K
#4 Santoprene® QP Kit	QP174K
#5 Santoprene® QP Kit	QP175K
#1 Versilon® QP Kit	QP17T1K
#2 Versilon® QP Kit	QP17T2K
#3 Versilon® QP Kit	QP17T3K
#4 Versilon® QP Kit	QP17T4K
#5 Versilon® QP Kit	QP17T5K

PUMP HEAD SERVICE KIT 6.9 bar max. EUROPE

Includes roller assembly, tube, duckbill, nuts, ferrules 6 mm, latches

DESCRIPTION	KIT
#1 Santoprene® QP Kit	QP691K
#2 Santoprene® QP Kit	QP692K
#7 Santoprene® QP Kit	QP697K
#1 Versilon® QP Kit	QP69T1K
#2 Versilon® QP Kit	QP69T2K

NOTE: Confirm chemical compatibility with the chemical resistance guide in the catalog.

PUMP TUBES

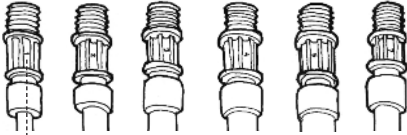

1 Tube number located on fitting

Refer to the **FLOW RATE OUTPUT** chart to match the pump with the correct tube

PUMP TUBE Includes ferrules 1/4"

DESCRIPTION	2-PK	5-PK
#1 Santoprene® Tube	UCCP201	MCCP201
#2 Santoprene® Tube	UCCP202	MCCP202
#3 Santoprene® Tube	UCCP203	MCCP203
#4 Santoprene® Tube	UCCP204	MCCP204
#5 Santoprene® Tube	UCCP205	MCCP205
#7 Santoprene® Tube (excludes Classic 100 or 170)	UCCP207	MCCP207
#1 Versilon® Tube	UCTYG01	MCTYG01
#2 Versilon® Tube	UCTYG02	MCTYG02
#3 Versilon® Tube	UCTYG03	MCTYG03
#4 Versilon® Tube	UCTYG04	MCTYG04
#5 Versilon® Tube	UCTYG05	MCTYG05

PUMP TUBE & DUCKBILL

Includes ferrules 1/4"

DESCRIPTION	2-PK
#1 Santoprene® Tube & Duckbill	UCCI1FD
#2 Santoprene® Tube & Duckbill	UCCP2FD
#7 Santoprene® Tube & Duckbill (excludes Classic 100 or 170)	UCCP7FD
#1 Versilon® Tube & Duckbill	UCTY1FD
#2 Versilon® Tube & Duckbill	UCTY2FD

PUMP TUBE EUROPE Includes ferrules 6 mm

DESCRIPTION	2-PK	5-PK
#1 Santoprene® Tube	UCCP21CE	MCCP21CE
#2 Santoprene® Tube	UCCP21CE	MCCP21CE
#3 Santoprene® Tube	UCCP23CE	MCCP23CE
#4 Santoprene® Tube	UCCP24CE	MCCP24CE
#5 Santoprene® Tube	UCCP25CE	MCCP25CE
#7 Santoprene® Tube (excludes Classic 100 or 170)	UCCP27CE	MCCP27CE
#1 Versilon® Tube	UCTY1CE	MCTY1CE
#2 Versilon® Tube	UCTY2CE	MCTY2CE
#3 Versilon® Tube	UCTY3CE	MCTY3CE
#4 Versilon® Tube	UCTY4CE	MCTY4CE
#5 Versilon® Tube	UCTY5CE	MCTY5CE

PUMP TUBE & DUCKBILL EUROPE

Includes ferrules 6 mm

DESCRIPTION	2-PK
#1 Santoprene® Tube & Duckbill	UC1FDCE
#2 Santoprene® Tube & Duckbill	UC2FDCE
#7 Santoprene® Tube & Duckbill (excludes Classic 100 or 170)	UC7FDCE
#1 Versilon® Tube & Duckbill	UCTY1DCE
#2 Versilon® Tube & Duckbill	UCTY2DCE

NOTE: Confirm chemical compatibility with the chemical resistance guide in the catalog.

INJECTION FITTINGS & CHECK VALVES



1/4" Duckbill Check Valve



3/8" Duckbill Check Valve



6 mm Duckbill Check Valve

INJECTION FITTINGS 25 psi max.

DESCRIPTION	EA	5-PK
1/4" Injection Fitting with Nut & Ferrule	UCAK300	MCAK300
3/8" Injection Fitting with Nut	UCAK400	————

INJECTION FITTINGS 1.7 bar max. EUROPE

DESCRIPTION	EA
6 mm Injection Fitting with Nut & Ferrule	UCAK3CE

DUCKBILL CHECK VALVES 100 psi max.

DESCRIPTION	EA	5-PK
1/4" Includes Santoprene® Duckbill, Nut, Ferrule	UCDBINJ	MCDBINJ
1/4" Includes Pellethane® Duckbill, Nut, Ferrule	UCTYINJ	MCTYINJ
1/4" Includes FKM Duckbill, Nut, Ferrule	UCKMINJ	MCKMINJ
3/8" Includes Santoprene® Duckbill, Nut	UCINJ38	MCINJ38
3/8" Includes Pellethane® Duckbill, Nut	UCTYU38	MCTYU38
3/8" Includes FKM Duckbill, Nut	UCKMI38	MCKMI38

DUCKBILL CHECK VALVES 6.9 bar max. EUROPE

DESCRIPTION	EA	5-PK
6 mm Includes Santoprene® Duckbill, Nut, Ferrule	UCINJCE	MCINJCE
6 mm Includes Pellethane® Duckbill, Nut, Ferrule	UCTINJCE	MCTINJCE
6 mm Includes FKM Duckbill, Nut, Ferrule	UCKMJCE	MCKMJCE

NOTE: Confirm chemical compatibility with the chemical resistance guide in the catalog.

FOR YOUR RECORDS

Pump Item Number

Serial Number

Date of Installation

STENNER PUMPS[®]

STENNER PUMP COMPANY

3174 DeSalvo Road
Jacksonville, Florida 32246
USA

Phone 904.641.1666
US Toll Free 800.683.2378
Fax 904.642.1012

sales@stenner.com
www.stenner.com

Hours (EST)
Mon.-Fri. 7:00 am-8:00 pm

 Assembled in the USA

© Stenner Pump Company
All Rights Reserved