

# Electric Pool Heaters | Smart POOL Series

## Technical Data

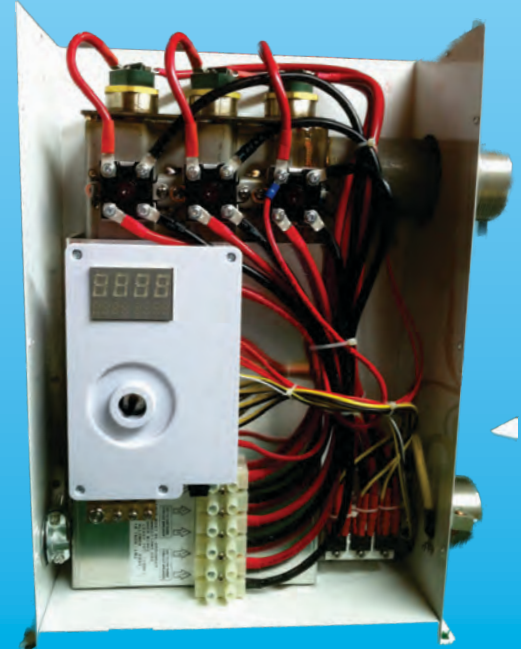

Interior View of Smart POOL 27

Model	Voltage	Phase	kW	Equivalent BTU	Max Amps	Plumbing Connection	Dimensions H" x W" x D"	Weight
Smart POOL 18	240	Single	18	61,000	75	2"	17 x 14 x 5.5	24.25
Smart POOL 27	240	Single	27	92,000	112.5	2"	17 x 14 x 5.5	24.25

## Smart POOL 27 Parts Diagram

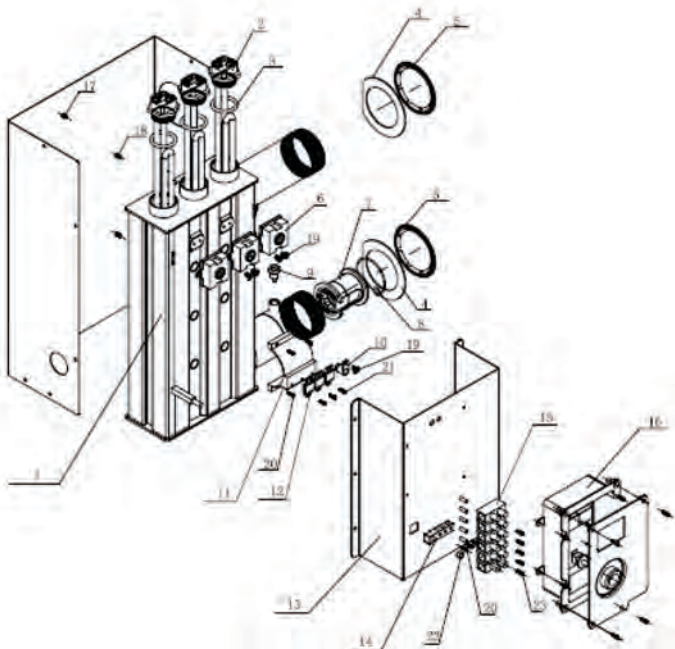

1	Heat Exchanger	12	Triac
2	Heating Elements	13	Aluminum Bracket
3	Gasket Rings	14	Ground Terminal Block
4	Inlet / Outlet Gasket	15	Terminal Block
5	Inlet / Outlet Fitting	16	Circuit Board Holder
6	Thermostats	17	Stainless Steel Screw M 4x12
7	Flow Sensor	18	Stainless Steel Screw M 4x10
8	Flow Sensor Fitting	19	Stainless Steel Screw M 4x6
9	Thermistor	20	Stainless Steel Screw M 4x10
10	Flow Sensor/Hall Effect	21	Stainless Steel Screw M 4x8
11	Cooling Plate		

# Electric Pool Heaters | Smart POOL Series

## Technical Data

### Spacing Dimensions

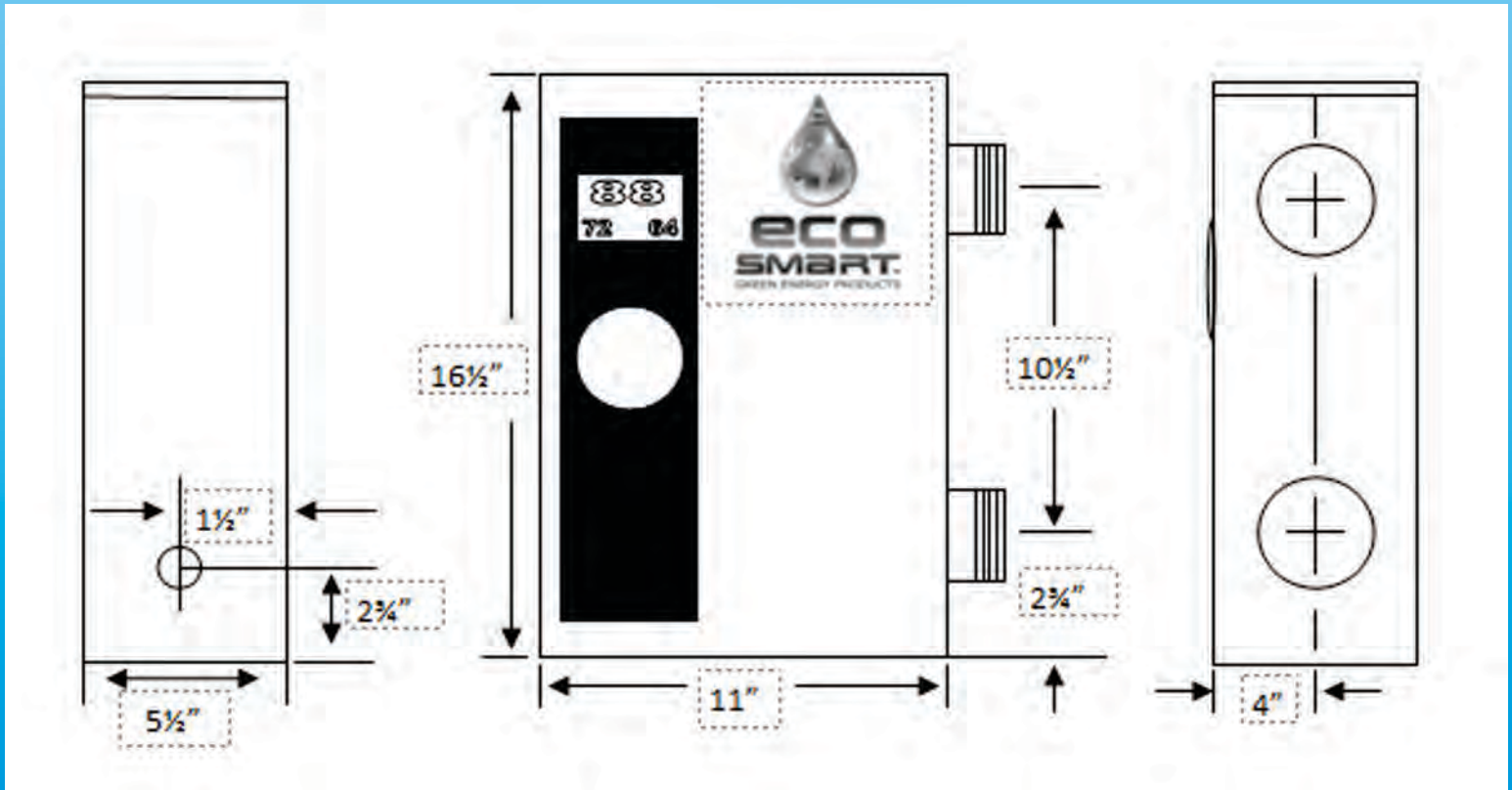







### Basic Sizing Information

Model	Spa/Pool Size W' x L' x D'	Gallons	Recommended Ecosmart Heater	Max. Gallons
Smart POOL 18	12 x 24 x 5	10,800	Smart POOL 18	11,000
Smart POOL 27	14 x 28 x 5	14,700	Smart POOL 27	15,000

\*For more sizing information please see "Sizing Charts."

### Product Features

-  **Stainless Steel Elements with 3/16" Brass Heads**
-  **Stainless Steel Water Tank - No Expansion**
-  **NO Relays or Contactors. Flow sensor Activation with microprocessing technology.**
-  **2" Inlet and Outlet Water Connection - Easy Installation**
-  **99.8% Energy Efficient.**
-  **Digital Temperature Control**



**Intertek**

ETL Listed to UL 1261 & CSA

### Quality Assurance

100% Testing of all units-All units are tested simulating its intended use with both water and electrical connections to ensure a trouble free out of the box experience.

ETL Listed to UL 1261 / CSA STD. ISO 9001 registered manufacturer