

ELM DISTRIBUTION SOLAR
POOL HEATING
INSTALLATION MANUAL

Rev. 3/2015



SAVE INSTALLATION TIME AND AVOID CALL-BACKS
READ THIS MANUAL BEFORE MOUNTING COLLECTORS

Manual Contents

This manual provides a detailed step-by-step procedure for the installation of an ELM Distribution Solar Pool Heating System. If the directions are followed correctly and only recommended ELM Distribution hardware and components are used, the installed system should provide years of trouble free service, savings, and enjoyment.

CAUTION:

SOLAR COLLECTORS ARE OFTEN INSTALLED ON THE ROOFS OF BUILDINGS. UNLESS YOU ARE VERY FAMILIAR WITH WORKING ON ROOFS AND HAVE THE PROPER LADDERS AND SAFETY EQUIPMENT FOR SUCH WORK, YOU SHOULD HIRE SOMEONE WITH THE NECESSARY EXPERIENCE TO DO THE INSTALLATION. FAILURE TO OBSERVE SAFE PRACTICES ON A ROOF OR OTHER ELEVATED STRUCTURE MAY RESULT IN FALLING, LEADING TO SERIOUS INJURY TO YOU.

Mounting Components

Contents

- *. [Overview](#)
- 1. [Collector Installation Kit](#)
- 2. [System Kit](#)
- 3. [Hold-Down Strap](#)
- 4. [Add-a-Row Kit](#)
- 5. [Row Spacer Kit](#)
- 6. [Aluminum Outlet Header Clamp Assembly](#)
- 7. [Double Hole Outlet Header Bracket](#)
- 8. [Optional Supplemental High Wind Area Collector Hold-Down Kit](#)
- 9. [Black Hose Clamps](#)
- 10. [Collector Repair Plug](#)
- 11. [Pipe Bracket](#)
- 12. [Outlet Header Clamp Assembly](#)

Overview

This section provides descriptions and part numbers of the ELM Distribution Installation Kits required for each solar pool heating system.

The mounting location of each kit component is shown by the corresponding circled number in the 'Mounting Components' diagram.

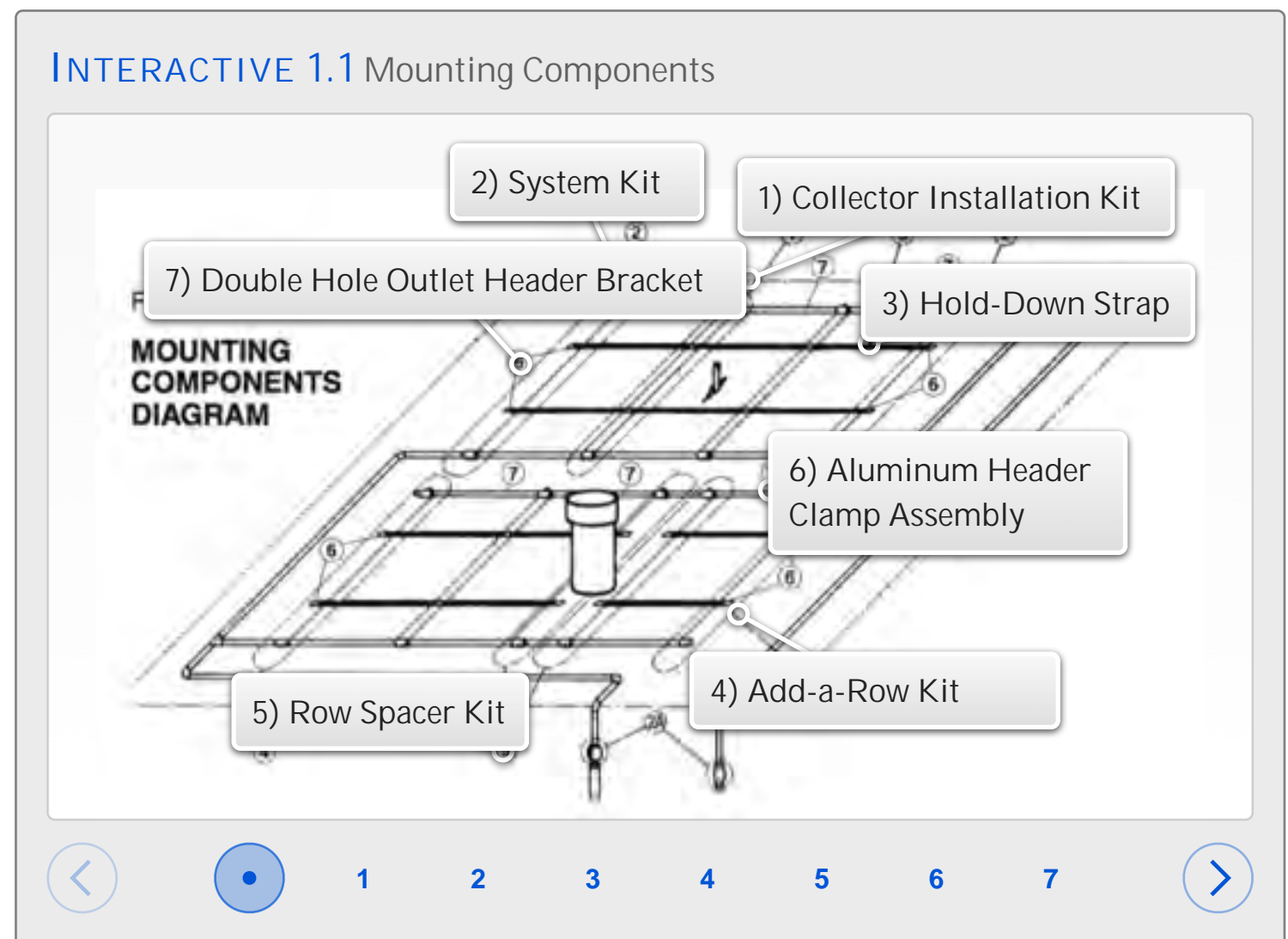

1) Collector Installation Kit

Part #12034-1 for 1 1/2" kit; #12034-2 for 2" kit

Contains the parts needed to fasten a single solar collector to a supporting surface and to make water connections from one collector to another. Hold-Down Strap is not included and must be ordered separately.

Use one (1) kit per collector.

Part No	Qty 1 1/2"	Qty 2"	Description
10008-1	1	—	Outlet Header Hold-Down Bracket Assembly
10008-2	—	1	Outlet Header Hold-Down Bracket Assembly
30340-1	1	1	Flashing Base, Outlet Header
30340-2	2	2	Flashing Base, Strap Bracket
50006	2	2	Hold-Down Strap Bracket
60003-1	4	—	Hose Clamp, Stainless Steel
60003-2	—	4	Hose Clamp, Stainless Steel
60690-1	2	—	Collector Connector Hose (3 3/4" long)
60690-2	—	2	Collector Connector Hose (3 3/4" long)

[Image 1.1](#) Collector Installation Kit



Go to: [Chapter 1 Home Page](#).

2) System Kit

Part #12135-1 for 1 1/2" kit; #12135-2 for 2" kit

Contains additional hold-down hardware, connection parts and adapters needed to complete water connections from the collectors to the system feed and return line. The pipe adapters that connect the system piping to the collectors are high temperature CPVC.

Use one (1) kit per system.

Part No	Qty 1 1/2"	Qty 2"	Description
10003-1	1	—	Vacuum Relief Valve
10003-2	—	1	Vacuum Relief Valve
10008-1	1	—	Outlet Header Hold-Down Bracket Assembly
10008-2	—	1	Outlet Header Hold-Down Bracket Assembly
10011	4	4	Hold-Down Strap Clamp Assembly
10035-2	1	1	Collector Hold Down Strap
12035-1	1	—	High Wind Hold-Down Kit (Not Shown)
12035-2	—	1	High Wind Hold-Down Kit (Not Shown)
30061-1	1	—	End Cap
30061-2	—	1	End Cap
30089-1	2	—	Pipe Adapter
30089-2	—	2	Pipe Adapter
30340-1	5	5	Flashing Base, Outlet Header
50069	4	4	Hold-Down Strap Bracket
60003-1	4	—	Hose Clamp, Stainless Steel
60003-2	—	4	Hose Clamp, Stainless Steel
60691-1	2	—	System Connector Hose (7" long)
60691-2	—	2	System Connector Hose (7" long)

[Image 1.2](#) System Kit



3) Hold-Down Strap

Part #10035-1 for 54'; #10035-2 for 107'; #10040 for 1400'

Required to secure collectors to the mounting surface. Use strap #10035-1 (54 ft) for rows of up to 6 collectors with two straps or #10035-2 (107 ft) for rows of up to 12 collectors with two straps. Additional strap is required when using [Optional Supplemental High Wind Area Collector Hold-Down Kit](#). Available in bulk, #10040 (1400 ft. roll.)

[Image 1.3](#) Hold-Down Strap



Go to: [Chapter 1 Home Page](#).

4) Add-a-Row Kit

Part #12043-1 for 1 1/2" kit; #12043-2 for 2" kit

Used when more than one row of collectors is to be installed. The kit contains additional hold-down hardware, connecting parts, and adapters.

Use one (1) kit for each collector row after the first.

<u>Part No</u>	<u>Qty 1 1/2"</u>	<u>Qty 2"</u>	<u>Description</u>
10003-1	1	—	Vacuum Relief Valve
10003-2	—	1	Vacuum Relief Valve
10008-1	1	—	Outlet Header Hold-Down Bracket Assembly
10008-2	—	1	Outlet Header Hold-Down Bracket Assembly
10011	4	4	Hold-Down Strap Clamp Assembly
30061-1	1	—	End Cap
30061-2	—	1	End Cap
30089-1	2	—	Pipe Adapter
30089-2	—	2	Pipe Adapter
30340-1	5	5	Flashing Base, Outlet Header
50069	4	4	Hold-Down Strap Bracket
60003-1	4	—	Hose Clamp, Stainless Steel
60003-2	—	4	Hose Clamp, Stainless Steel
60691-1	2	—	System Connector Hose (7" long)
60691-2	—	2	System Connector Hose (7" long)

[Image 1.4](#) Add-a-Row Kit



Go to: [Chapter 1 Home Page](#); [Special Systems Layout](#).

5) Row Spacer Kit

Part #12017-1 for 1 1/2" kit; #12017-2 for 2" kit

Used when a row of collectors must be interrupted by a space to allow for obstructions such as a chimney or roof vent. It contains the hardware needed to space around any width obstructions by connecting appropriate lengths of PVC pipe to the pipe adapters at the inlet and outlet headers of the two collectors on either side of the obstructions.

Use one (1) for each gap between collectors

Use when required.

<u>Part No</u>	<u>Qty 1 1/2"</u>	<u>Qty 2"</u>	<u>Description</u>
10008-1	1	—	Outlet Header Hold-Down Bracket Assembly
10008-2	—	1	Outlet Header Hold-Down Bracket Assembly
10011	4	4	Hold-Down Strap Clamp Assembly
30089-1	4	—	Pipe Adapter
30089-2	—	4	Pipe Adapter
30340-1	5	5	Flashing Base, Outlet Header
50069	4	4	Hold-Down Strap Bracket
60003-1	4	—	Hose Clamp, Stainless Steel
60003-2	—	4	Hose Clamp, Stainless Steel
60690-1	2	—	Collector Connector Hose (3 3/4" long)
60690-2	—	2	Collector Connector Hose (3 3/4" long)

[Image 1.5](#) Row Spacer Kit



Go to: [Chapter 1 Home Page](#); [Mounting the Solar Collectors](#); [Installation Over Roof Vent Pipes](#); [Special Systems Layout](#).

6) Aluminum Outlet Header Clamp Assembly

Part #10117-1 for 1 1/2"; #10117-2 for 2"

Used as supplemental outlet header mounting in conjunction with the Outlet Header Hold-Down Bracket assembly, Part #10008-1. The bracket is designed for installations that require more flexibility for the outlet header mounting hardware location, such as barrel tile roofs or installations that require additional mounting.

[Image 1.6](#) Aluminum Outlet Header Clamp Assembly

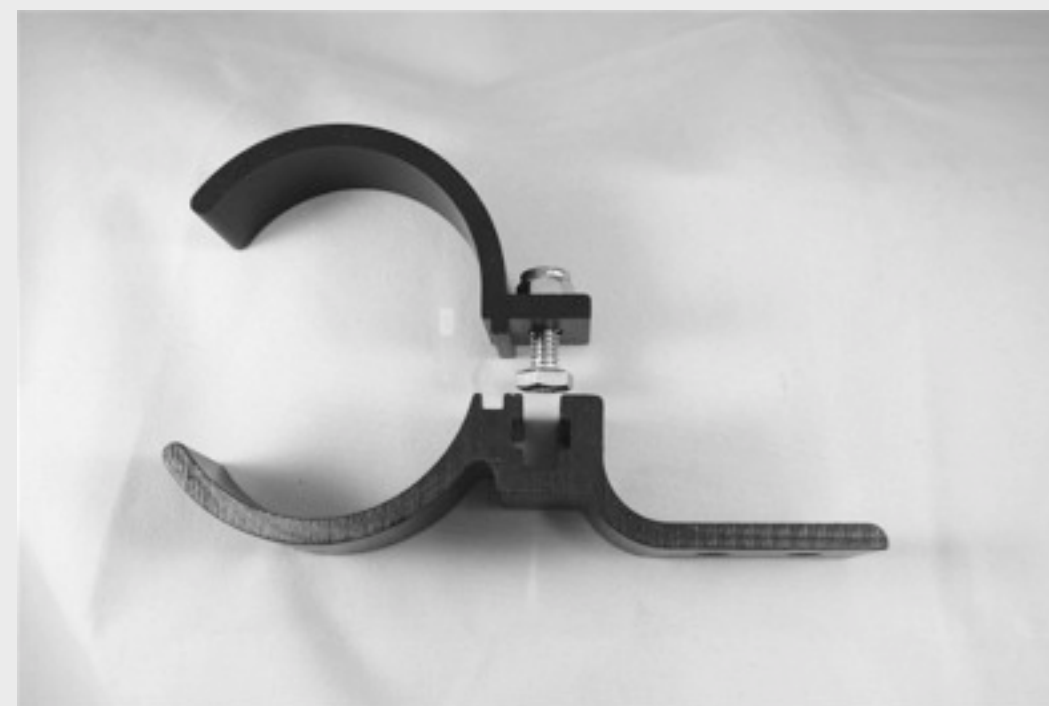

Go to: [Chapter 1 Home Page](#); [Step Seven](#).

7) Outlet Header Bracket Options

Part #50005: Single Hole Outlet Header Bracket

Part #50069: Double Hole Outlet Header Bracket

May also be used to terminate a strap run in high wind areas where extra hold-down strength is required.

[Image 1.7](#) Single Hole Outlet Header Bracket

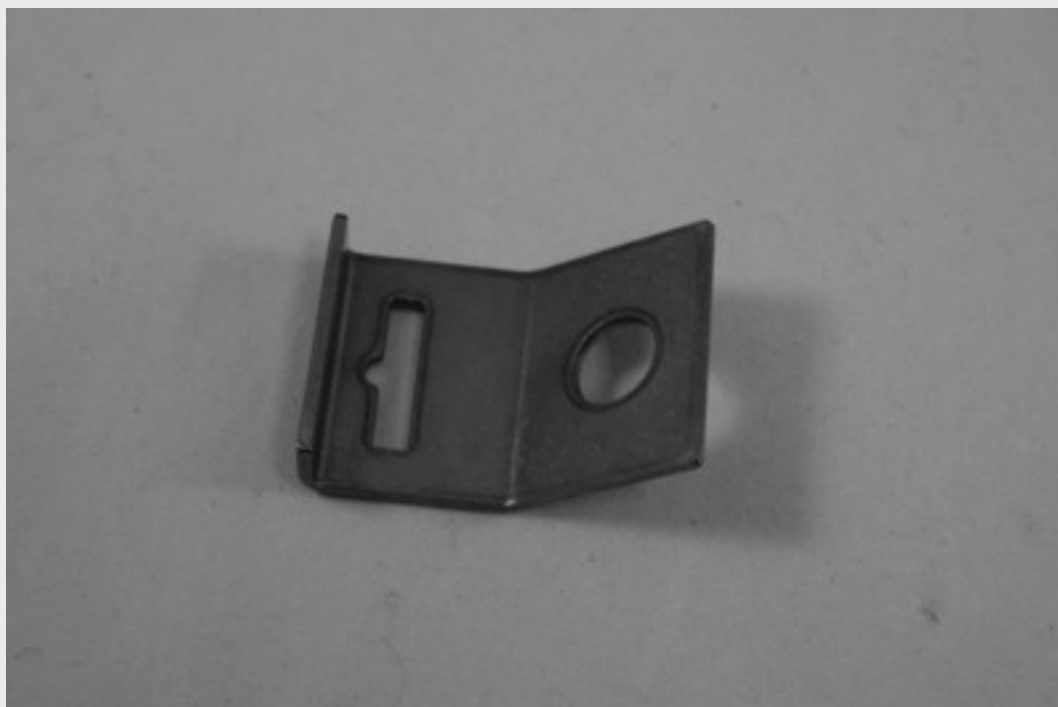

[Image 1.7 a](#) Double Hole Outlet Header Bracket

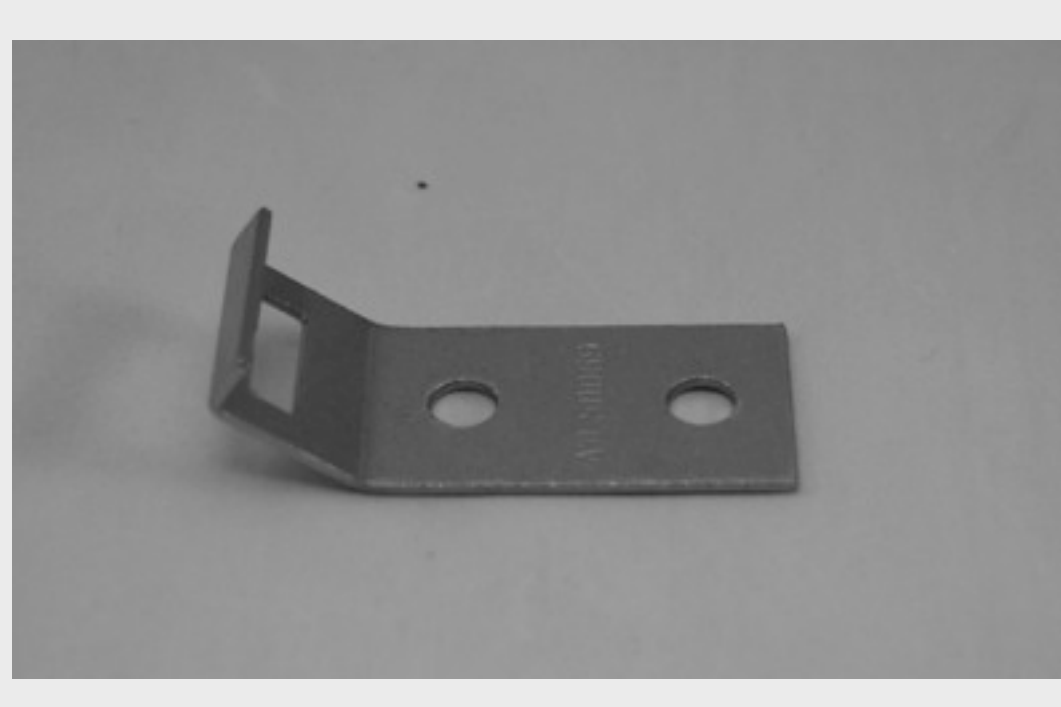

Go to: [Chapter 1 Home Page](#).

8) Optional Supplemental High Wind Area Collector Hold-Down Kit

Part #12035-1 for 1 1/2" , #12035-2 for 2"

Used in addition to the basic collector installation kit in regions where high winds are prevalent.

Requires twice the amount of [Hold-Down Strap](#).

Use (1) kit per system.

Part No	Qty 1 1/2"	Qty 2"	Description
10002-1	1	—	High Wind Hold-Down Assembly
10002-2	—	1	High Wind Hold-Down Assembly
30340-1	1	1	Flashing Base, Outlet Header
30340-2	2	2	Flashing Base, Strap Bracket
50006	2	2	Hold-Down Strap Bracket

[Image 1.8](#) Optional Supplemental High Wind Area Collector Hold-Down Kit



Go to: [Chapter 1 Home Page](#); Installation in High Wind Areas.

9) Black Hose Clamps

Part #60548-1 for 1 1/2"; #60548-2 for 2"

Our standard stainless steel hose clamps with an aesthetic black, durable electrostatically applied powder-paint coating.

[Image 1.9](#) Black Hose Clamps



Go to: [Chapter 1 Home Page](#).

10) Collector Repair Plug

Part # 30143

Used as an easy and permanent on site repair of a collector by isolating the leaking riser tube.

[Image 1.10](#) Collector Repair Plugs



Go to: [Chapter 1 Home Page](#); [Repair Plug](#).

11) Pipe Bracket

Black- Part #30272-1 for 1 1/2"; 30272-2 for 2"

White- Part #30284-1 for 1 1/2"; 30284-2 for 2"

Used for supporting feed and return line piping on the roof or other mounting surface. The Pipe Brackets are made from a high-strength glass-reinforced polypropylene. Insert the attached wedge to allow for pipe expansion and contraction.

[Image 1.11](#) Pipe Brackets

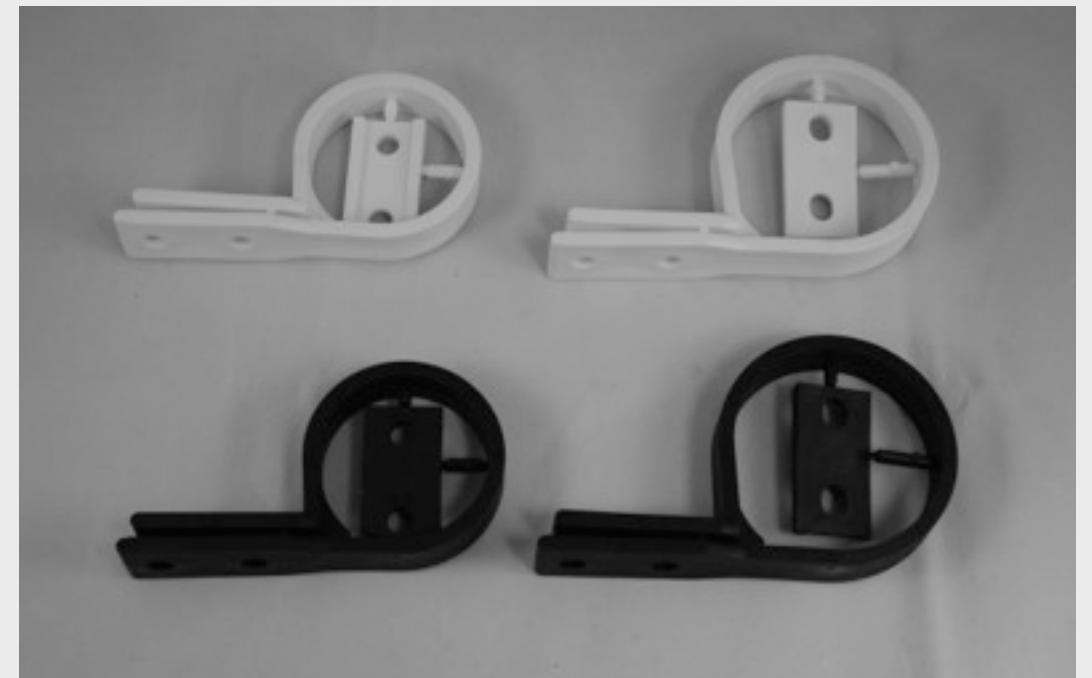

Go to: [Chapter 1 Home Page](#); [System Piping Overview](#).

12) GFPP Outlet Header Clamp Assembly

Part #10121; #12141 for bulk quantity of 25 including 50 locking screws

Used as supplemental outlet header mounting in conjunction with the Outlet Header Hold-Down Bracket assembly, Part #10008-1. The bracket is made from high-strength glass-reinforced polypropylene and is designed for installations that require more flexibility for the outlet header mounting hardware location, such as barrel tile roofs or installations that require additional mounting hardware to be anchored into rafters or beams.

Can be used for both 1 1/2" and 2" headers. It is shipped with the insert for 1 1/2" headers preinstalled. For 2" Headers remove this insert by pulling it apart. See exploded view below.

[Image 1.12](#) Outlet Header Clamp Assembly



Go to: [Chapter 1 Home Page](#); Step Seven.

Mounting the Solar Collectors

Contents

- *. Overview
- 1. Outlet Header Bracket Locations
- 2. Drill Along Chalkline
- 3. Outlet Header Bracket Sealant
- 4. Hold-Down Strap Bracket Locations
- 5. Install Hose
- 6. Install Outlet Header Bracket with Hose
- 7. Header Clamp Assembly
- 8. Install Hold-Down Strap Bracket
- 9. Install Strap
- 10. Install Vacuum Relief Valve
- 11. Install End Cap
- 12. Final Inspection
- 13. Installation in High Wind Areas
- 14. Installation Over Roof Vent Pipes

Overview

When mounting the collectors, always make provisions for inlet connections at the bottom header and outlet connections at the top. The outlet headers must be pitched a vertical distance of at least 1/8" per foot above the inlet headers to assure uniform flow and proper drainage to prevent freezing. Plan the collector location to allow at least one foot on all sides of the row(s) of collectors for mounting brackets and piping.

Roof obstructions, if present, should now be taken into consideration to determine the exact collector location. Collectors can be installed over or around different diameter roof vent pipes or other obstructions. After snapping the top chalk lines but before marking and pre-drilling for your outlet header brackets, refer to the following instructions:

- With roof vents up to 2" (50mm) in diameter the collectors can be installed directly over these vents. Locate the seam in the panel nearest to where the vent pipe is to come through. Separate by pulling up on top plate, and pushing down on the lower plate. Should the vent pipe protrude near a sonic tack weld, it will have to be cut apart. Using a sharp utility knife, cut through the weld while pulling the two plates apart. Lay the collector over the vent pipe, keeping the vent pipe at least 12 inches (30cm) away from a header. It will be easier to complete an installation by mounting this panel first and then working away from it.
- For a roof vent pipe over 3" (80mm) in diameter, the collectors can be positioned on either side of the vent. Two 7" (18cm) System Connector Hoses (Part #60691-1 for 1 1/2" or #60691-2 for 2") can be employed to couple the collectors together for vent pipes or other obstacles up to 7" (18cm) in diameter. Mark your 51" (128cm) centers wherever the outlet header brackets 'fall' on the upper chalk line. With obstructions of over 7" (18cm), such as attic fans and skylights, lay out the panels on either side of the obstructions using a [Row Spacer Kit](#) (Part #12017-1 for 1 1/2"; #12017-2 for 2").
- Refer to [Figure 2](#) throughout this section.

Return to: [Chapter 2 Home Page](#).

Step One: Outlet Header Bracket Location

Determine the position of the last Outlet Header Hold-Down Bracket for the row of collectors. Mark this point on the roof. The Collector Outlet Headers will be located 1" (25mm) below this mark.

Refer to [Figure 3](#).

FIGURE 3 Outlet Header Bracket Location



Step Two: Drill Along Chalkline

Using this point, snap a chalk line to the opposite end of the row. Slope this line down the roof toward the inlet. A minimum of 1/8" per foot.

Using a 1/8" (3mm) drill bit for 1/4" (6mm) diameter screws drill a hole for the first Outlet Header Bracket on the first roof mark. Measure up 1" on center from the first pilot hole and drill pilot hole for second screw. Repeat this process at 51" centers along the chalk line for the total number of collectors to be installed.

Step Three: Outlet Header Bracket Location

Inject a generous amount of high quality sealant into each hole and onto the surrounding roof surface. Bolt all the outlet header Hold-Down Brackets to the roof as shown in [Figure 4](#).

FIGURE 4 Outlet Header Bracket

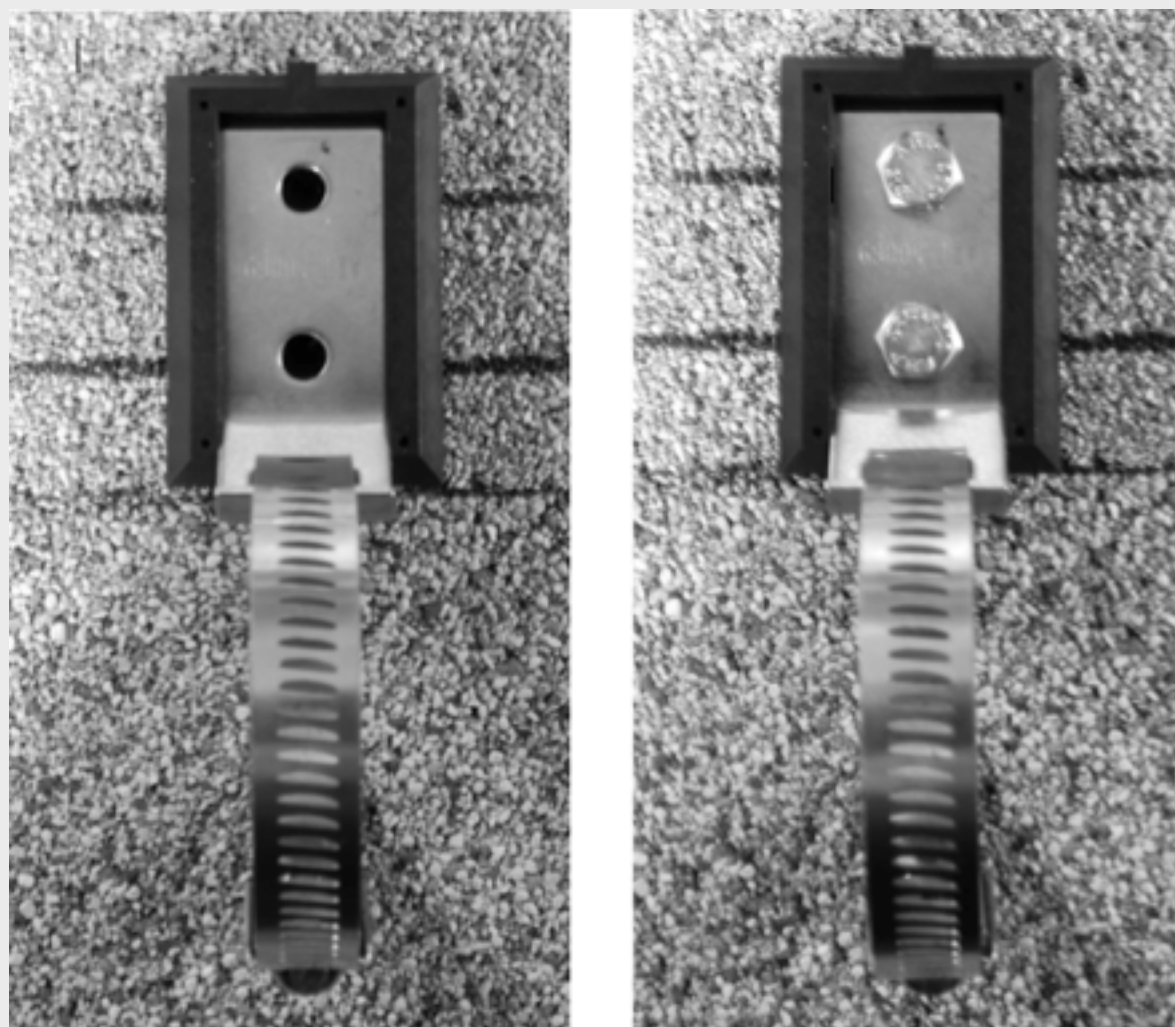

Return to: [Chapter 2 Home Page](#).

Step Four: Hold-Down Strap Bracket Locations

Locate the Hold-Down Strap Bracket holes using the information in *Table 2A* shown below, (also shown in [Figure 2 Table A](#)). Measuring from the top outlet header bracket chalk line, snap another chalk line parallel to this line using the “A” distance. The “B” distance is the same for all collector sizes, which is 16” (40cm) up from the outside of the bottom header and can be measured after the collectors are installed. Wait to install the Hold-Down Strap Brackets until after the collectors are installed so as not to damage the collectors when you are bringing them to the roof for installation.

TABLE 2 A Distance Between Panel Headers and Straps

COLLECTOR PANEL SIZE, FEET (M)	12 (3.6)	10 (3.0)	8 (2.4)	6 (1.8)	4 (1.2)
COLLECTOR (A) DISTANCE, INCHES (CM)	60 (152)	48 (122)	36 (91)	24 (60)	---
COLLECTOR (B) DISTANCE, INCHES (CM)	16 (40)	16 (40)	16 (40)	16 (40)	16 (40)

Return to: [Chapter 2 Home Page](#).

Step Five: Install Hose

Bring the first collector to the roof and slip the proper hoses over both ends of the inlet and outlet headers on the last return collector. Make sure that the header with the serial number label is used for the outlet or top header with the serial number label facing downwards towards the mounting surface. The System Connector Hoses (Part #60691-1 for 1 1/2"; # 60691-2 for 2"), go on the outlet of the last collector and the inlet of the first collector. Place a Hose Clamp between the two indicator ridges on the hose, in order to center it over the sealing groove in the header. This clamp must face up so as to be accessible for tightening and not rub against the mounting surface.

Make sure you securely tighten each clamp with a nutdriver. If a nutdriver is not available, a 'hex' wrench or screwdriver will suffice. **THE HOSE CLAMPS MUST BE LOCATED BETWEEN THE TWO INDICATOR RIDGES ON THE HOSE. DO NOT OVER TIGHTEN!**

Refer also to [Figure 2](#).

Step Six: Install Outlet Header Bracket with Hose

Position the collector on the roof so that the center of the outlet connection hoses are directly beneath the secured outlet header brackets. Open the clamp that is part of the outlet header bracket, insert connection hose and **LIGHTLY TIGHTEN** the clamp around the hose. Loosely place another clamp over the open end of the hose before installing the next collector in the array. Refer to [Figure 5](#). Continue to install all the collectors in the array, coupling them side to side.

FIGURE 5 Installed Outlet Header Bracket with Hose



Step Seven: Header Clamp Assembly

If the [Aluminum Header Clamp Assembly](#), Part #10117-1 for 1 1/2"; #10117-2 for 2" is to be used for supplemental mounting hardware, install over the outlet header at this time.

Step Eight: Install Hold-Down Strap Bracket

Proceed to the lower chalk line previously snapped on the roof for the Hold-Down Strap Brackets. Mark a hole 2" (5cm) to the side of the first collector and continue marking holes on the chalk line centered exactly between the absorber surfaces until you reach the last collector. Mark the last hole the same 2" (5cm) to the side of the last collector. Drill a pilot hole and apply sealant at each of these locations. Bolt the Hold-Down Strap Brackets on the roof. Refer to [Figure 6](#). Mark the holes for the bottom Hold-Down Strap by measuring up 16" (40cm) from the outside of the bottom header and again centering them between the absorbers and 2" (5cm) away from the first and last collector. It is OK to step on the collectors as long as you stay one foot away from the top and bottom headers.

FIGURE 6 Strap Bracket

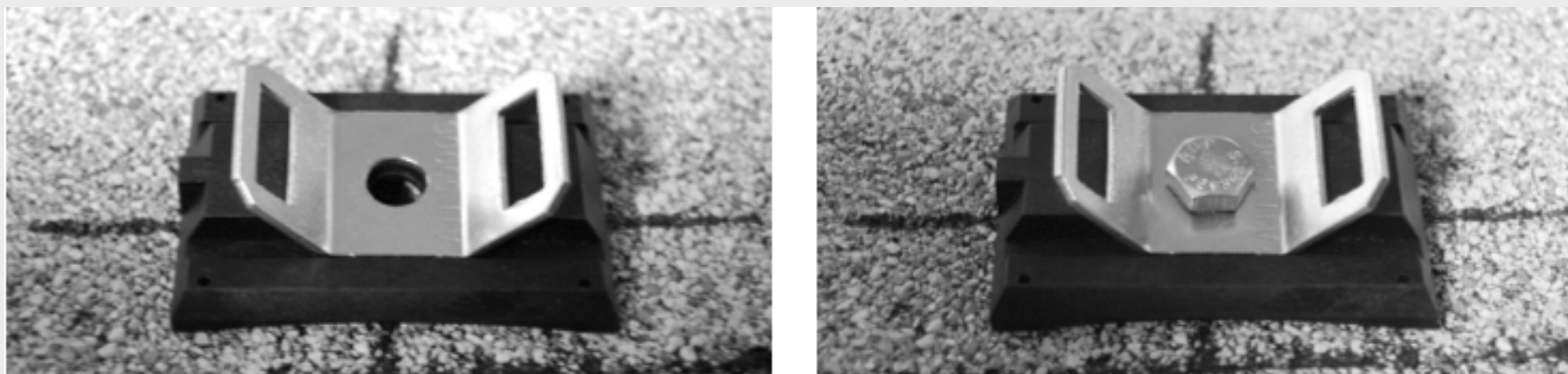

Step Nine: Install Strap

Slip a Strap Hold-Down Clamp over one end of the strap prior to sliding the strap between both slots of the Hold-Down Strap Bracket. Bend over approximately 3" of the strap (refer to [Figure 7](#)) and slide it through the one exposed slot of the Hold-Down Strap Bracket and then back through the Hold-Down Strap Clamp. Slide the Hold-Down Strap Clamp towards the Hold-Down Strap Bracket. Clamp screw should be tightened securely, but not over-tightened to the point where the clamp is distorted. (refer to [Figure 8](#)) Bring the remaining strap end across the collector face, passing through both slots in the bracket located on the other side of the collectors. Repeat strap termination at opposite end. *Pull the straps taut against the face of the collectors. Repeat this procedure for the remaining Hold-Down Strap. (refer to [Figure 9](#))*

FIGURE 7 Termination Strap Bracket Assembly



FIGURE 8 Termination Strap Bracket Assembly

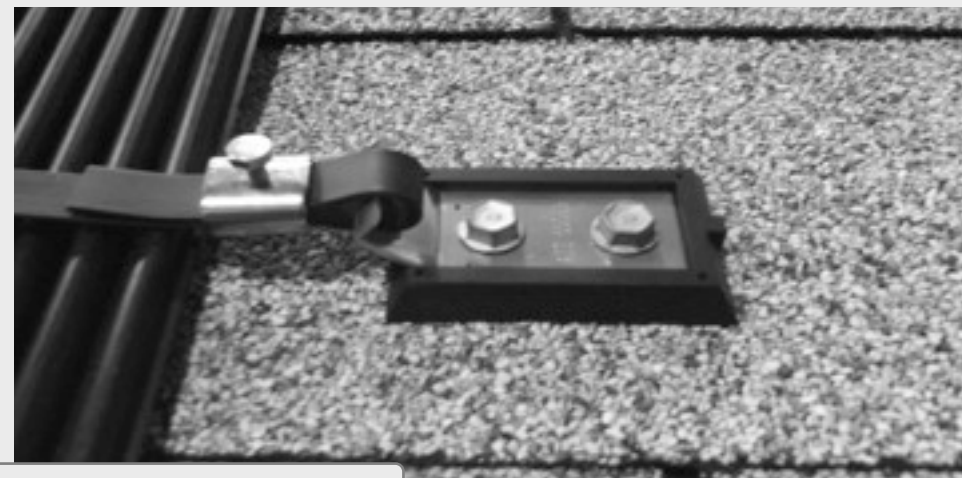

FIGURE 9 Strap Bracket with Strap



Return to: [Chapter 2 Home Page](#).

Step Ten: Install Vacuum Relief Valve

Install the Vacuum Relief Valve (Part #10003-1 for 1 1/2"; #10003-2 for 2") in the outlet header of each row. This will be located at the opposite end of the header that is connected to the collector return line. Refer to [Figure 10](#).

DO NOT OVER TIGHTEN THE CLAMP!

Also, refer to [Figure 2](#), [Figure 12](#), [Figure 13](#), and [Figure 14](#).

FIGURE 10 Installed Vacuum Relief Valve



Step Eleven: Install End Cap

Install an End Cap, (Part # 30061-1 for 1 1/2"; #30061-2 for 2") in the inlet header of each row, opposite the end that is connected to the collector inlet pipe. Refer to [Figure 11](#).

DO NOT OVER TIGHTEN THE CLAMP!

Also, refer to [Figure 2](#), [Figure 12](#), [Figure 13](#), and [Figure 14](#).

FIGURE 11 Installed End Cap



Return to: [Chapter 2 Home Page](#).

Step Twelve: Final Inspection

INSPECT THE INSTALLATION AND CHECK ALL CLAMPS FOR PROPER POSITION AND TIGHTNESS.

Installation in High Wind Areas

When Installing in High Wind Areas it is recommended to use the [Optional Supplemental High Wind Area Collector Hold-Down Kit](#), Part #12035-1 for 1 1/2"; #12035-2 for 2".

Install an Inlet Header Hold-Down Assembly to each of the panel's inlet header connection hoses. Stretch the spring 3/4" to locate the first hole. Using a 1/8" (3mm) drill bit for 1/4" (6mm) diameter screws drill a hole for the first outlet header bracket on the first roof mark. Measure down 1" on center from the first pilot hole and drill pilot hole for second screw. Insert a generous amount of high quality sealant into each hole and onto the surrounding roof surface. Tension the bracket's spring and bolt the bracket securely to the mounting surface. Repeat this step for the other inlet connection hoses.

NOTE: DO NOT STRETCH THE SPRING MORE THEN 3/4". OVER TENSIONING THE SPRING WHEN THE PANEL IS EXPANDED ON A HOT DAY CAN LEAD TO PANEL DAMAGE WHEN IT CONTRACTS ON A COOL DAY/NIGHT.

See *Table 2B* below and [Figure 15](#) for additional strap bracket locations.

TABLE 2 B

COLLECTOR PANEL SIZE, FEET (M)	12 (3.6)	10 (3.0)	8 (2.4)
DIMENSION OF (A), INCHES (CM)	32 (81)	28 (71)	20 (51)

Return to: [Chapter 2 Home Page](#).

Installation Over Roof Vent Pipes

- Collector models 10001 and 10204 with intermittent sonically welded plates can be installed over or around different diameter roof vent pipes or other obstructions up to 2" (63mm) in diameter. After snapping the top chalk lines but before marking and pre-drilling for your outlet header brackets, locate the seam in the collector nearest to where the vent pipe is to come through. Separate by pulling up on top plate, and pushing down on the lower plate. Should the vent pipe protrude near a sonic tack weld, it will have to be cut apart. Using a sharp utility knife, cut through the weld while pulling the two plates apart. Lay the collector over the vent pipe, keeping the vent pipe at least 12" (30.5cm) away from a header. It will be easier to complete an installation by mounting this collector first and then working away from it.
- If you have the installation flexibility it is easier to locate vent pipes up to 2" between adjacent collectors.
- With a roof vent pipe of 3" (8cm) in diameter, the collectors can be positioned on either side of the vent. Two System Connector Hoses (Part #60691-1 for 1 1/2"; # 60691-2 for 2") can be employed to couple the collectors together for vent pipes or other obstacles up to 7" (17cm) in diameter. Mark your 51" (1.3m) centers wherever the outlet header brackets 'fall' on the upper chalk line.
- With obstructions of over 7" (17cm), such as attic fans and skylights, lay out the collectors on either side of the obstruction using a [Row Spacer Kit](#) (Part #12017-1 for 1 1/2"; #12017-2 for 2").

See Diagram or refer to [Figure 16](#) .

Return to: [Chapter 2 Home Page](#).

System Piping

Contents

- *. Overview
- 1. Flow Rate
- 2. Reverse Return
- 3. Direct Return
- 4. Optional Isolation Valves
- 5. Collector By-Pass Check Valve
- 6. Special System Layouts
- 7. System Below Pool Level

System Piping Overview

- The most common piping configurations use a pressure filter. The pump draws the water from the skimmer and/or a main drain, forcing it through the filter and sending it back to the pool through the return lines. (For other types please contact factory)

If a fuel-fired heater or heat pump is installed, it is located between the collector return line and the return line to the pool. The pipes to and from the solar collectors are connected to the return line to the pool before the water enters the fuel-fired heater.

- Whenever there is more than 50 gpm (189L) required flow rate to the collectors or more than 100' (30m) of piping used in a system, install 2" (63mm) piping to and from the collectors. (See [Table 3A](#) for Pipe Size based on Flow Rate.) Piping to and from the collectors should be the same type of plastic piping and fittings approved for use with swimming pool filters and pumps. It is recommended to always use Schedule 40 PVC pipe and fittings.
- Although PVC pipe is generally white, black is also available but may be difficult to find locally. If for aesthetics black pipe is desired it can always be painted black. Before painting, the PVC pipe must be wiped with cleaner to remove the glossy surface coating. This will ensure that the paint will not flake off prematurely.
- Use a PVC cutter or a PVC wide-blade saw (not a hacksaw) for cutting pipe. It is important to use both a quality cleaner/primer and solvent in gluing a PVC joint. Finally, use a cloth while either gluing or painting to keep the job a clean one.
- Piping should also be supported at intervals based on pipe size. (See [Table 3A](#).)

Refer to [Figure 12](#), [Figure 13](#), and [Figure 14](#) throughout this section.

Return to: [Chapter 3 Home Page](#).

System Piping Overview Cont.

TABLE 3 A

FLOW RATE (GPM)	MIN. PIPE SIZE @ 7FT/S VELOCITY (INCHES)	MINIMUM FLOW TO PURGE AIR			SUPPORT CENTERS FOR HORIZONTAL PVC PIPE (FEET) @100°F	
		FLOW-UP	HORIZONTAL FLOW	DOWN FLOW	SDR&SCH. 40	SCH. 80
		2 FT/S	4 FT/S	6 FT/S		
40	1-1/2	11	22	33	5	5-1/2
80	2	20	39	59	5	6
115	2-1/2	31	61	92	5-1/2	6-1/2
160	3	44	88	132	6	7
300	4	78	157	235	6-1/2	7-1/2
650	6	176	353	529	7-1/2	9
1050	8	300	650	1000	8	9-1/2

Note: Where Pipe sizes are not available or total pipe run exceeds 100ft, use the next larger size pipe.

Return to: [System Piping Overview](#).

Flow Rate

- In order to receive optimum performance from ELM Distribution collectors, the following recommended flow rates and number of collectors per row should be followed. When the system is running, all the collectors should feel uniformly cool to the touch, and there should be no residual air left in the pool return lines. If either of these two conditions persist, chances are that the flow rates thru the collectors are inadequate or the system is not properly balanced. A flow meter can be installed in the collector feed line to check on the flow rate. If the flow rates are within the limits as shown below in *Table 3B*, then the system may not be properly balanced, especially with systems requiring multiple banks of collectors. Refer to [Special System Layouts](#).
- If the flow rate is below the minimum as shown in the table above, then the pool pump size or pipe size should be increased, or a booster pump installed in some cases. If the flow rate is excessive (more than 10 GPM/(37.9l) collector), or if the system pressure is greater than 30 psi, a bypass line should be installed between the collector feed and return lines above the 3-way valve to prevent problems with the collectors and connection hoses.
- If there is residual air in the pool return lines and the collectors do feel cool to the touch, refer to the section concerning the [Vacuum Relief Valve Test](#) (*Chapter 6 Section 3.*)

Return to: [Chapter 3 Home Page](#).

TABLE 3 B

COLLECTOR SIZE, FEET:	4 X 12	4 X 10	4 X 8
STANDARD FLOW RATE PER COLLECTOR, GPM (LTR/MIN)	5.0 (18.9)	4.0 (15.1)	3.25 (12.5)
MINIMUM FLOW RATE PER COLLECTOR, GPM (LTR/MIN)	3.0 (11.4)	2.5 (9.5)	2.5 (9.5)
MAXIMUM # COLLECTORS PER ROW, 1 1/2"; 2"	10; 12	12; 12	12; 14
MAXIMUM SQUARE FOOTAGE PER ARRAY, 1 1/2"; 2"	480; 576	480; 576	480; 576
PRESSURE DROP, PSI@GPM: 1 1/2"; 2"	0.05@2.5; 0.05 @2.5	0.13@5.0; 0.20@5.0	0.39@10.0; 0.60@10.0

Reverse Return

Refer to [Figure 17](#).

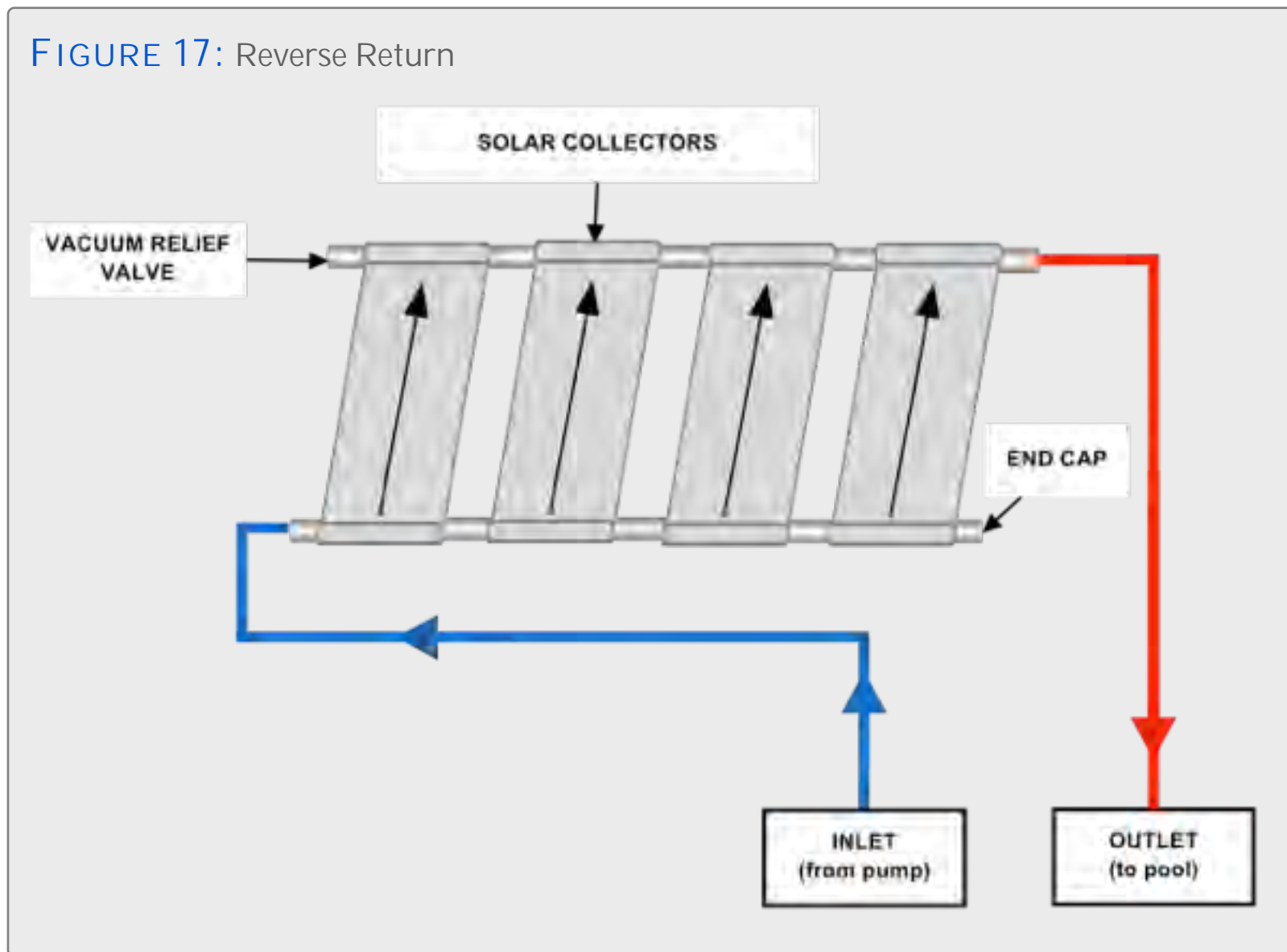

Return to: [Chapter 3 Home Page](#).

Direct Return

Refer to [Figure 18](#).

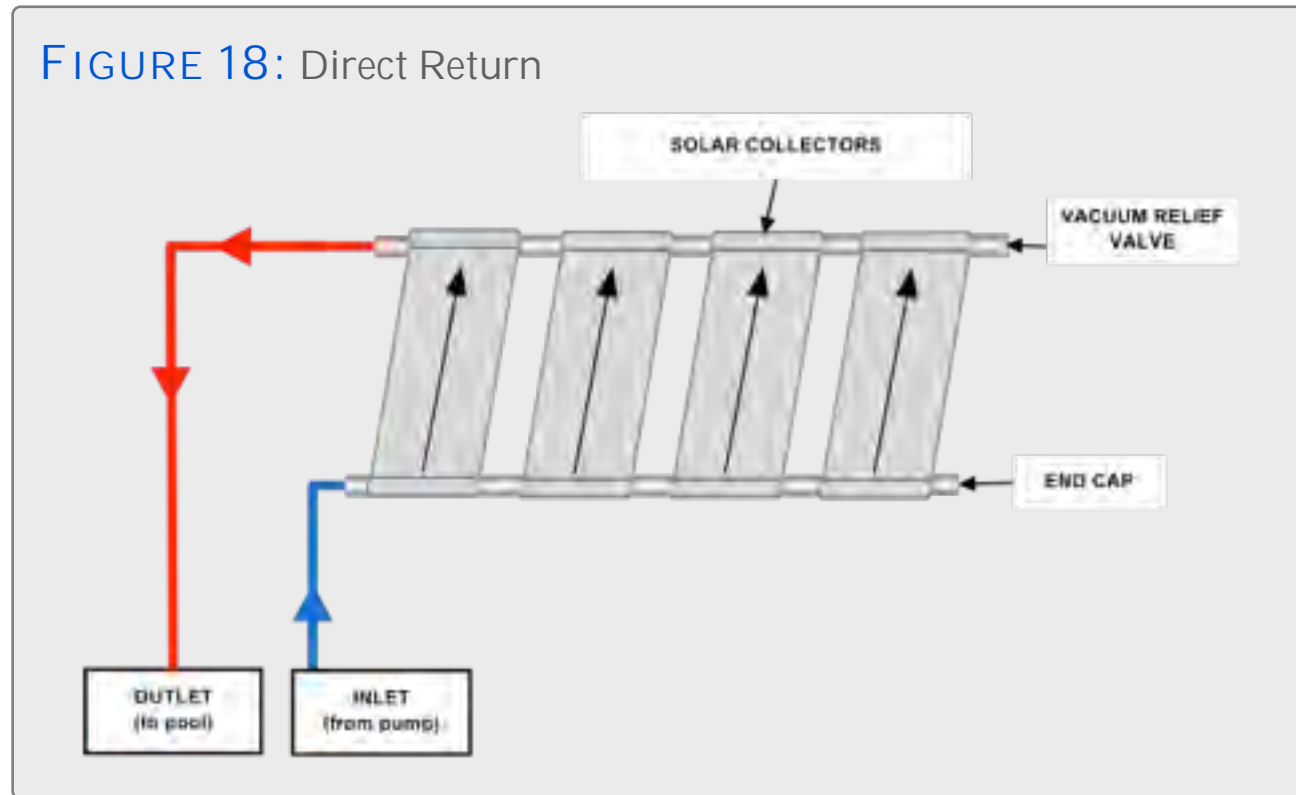

TABLE 3 C Number of Recommended Collectors to Use in a Direct Return System

COLLECTOR SIZE:	8'		10'		12'	
	1 1/2"	2"	1 1/2"	2"	1 1/2"	2"
MINIMUM FLOW RATE (0.06 GPM/FT ²)	-	-	-	-	-	-
STANDARD FLOW RATE, (0.10 GPM/FT ²)	6	6	6	6	6	6
RECOMMENDED FLOW RATE, (0.15 GPM/FT ²)	7	8	7	8	7	7
MAXIMUM FLOW RATE, (10 GPM PER COLLECTOR)	8	12	8	10	8	8

Optional Isolation Valves

- Isolation valves may be installed in the collector piping so that the pool may be operated while the collectors are being serviced or during freezing weather. Install a manually operated ball valve in the collector inlet line and a check valve on the collector return line.
- For further precautions in warm climates where pools are operated year round and periodic freezes can occur, a bypass line (small diameter tubing) can be located above the ball and check valve so as to prevent any accidental trapping of water in the collectors by the pool owner. To make sure no water is left in the collectors for servicing or during freezing conditions, remember that the pool pump should be shut off, allowing the collectors to drain naturally, before the optional isolation valves are used.
- If the system is installed on a commercial or public pool, local codes may require positive isolation valves in the collector feed and return lines. See [Figure 16 A](#) for the proper placement of the isolation check valve and pressure relief valve.

Collector By-Pass Check Valve

At high flow rates above the collector's recommendation, the valve opens to by-pass the water and only send the recommended flow rate to the system. This is to relieve stresses on the collector system, the system pump, along with preventing filtration issues.

See tables below for what spring to use for various flow rates.

Refer to [Figure 12 A](#).

TABLE 3 D 6 lb Spring

GPM FROM PUMP	GPM TO SYSTEM	GPM BY-PASSED
40	25	15
50	35	15
60	41	19
70	47	23
80	57	23
90	65	25
100	72	28

TABLE 3 E 10 lb Spring

GPM FROM PUMP	GPM TO SYSTEM	GPM BY-PASSED
40	36	4
50	38	12
60	39	21
70	42	28
80	46	34
90	48	42
100	50	50

Return to: [Chapter 3 Home Page](#).

Special System Layouts

- Use a divided system when installing more than the recommended maximum number of collectors per row, when avoiding roof obstructions, or where limited space dictates. This provides uniform distribution of water through all the collectors. If water distribution through the collectors is non-uniform, the heating capacity of the system will be reduced.
- WHEN INSTALLING A DIVIDED SYSTEM, THE OUTLET HEADERS FROM EACH OF THE LOWER (OR CLOSEST) ROWS OF COLLECTORS MUST BE CONNECTED TO THE HIGHEST (OR FURTHEST) POINT IN THE SYSTEM.

Refer to [Figure 14](#)

- A divided system requires an [Add-A-Row Kit](#) (Part #12043-1 for 1 1/2"; #12043-2 for 2") for each additional row of collectors. This also illustrates the application of the [Row Spacer Kit](#) (Part # 12017-1 for 1 1/2"; #12017-2 for 2") to clear a roof obstruction.

System Below Pool Level

If the collectors are to be installed below the level of the pool, isolation ball valves and a manual drain should be installed. If the system requires the use of a booster pump, it should be located on the return line from the collectors. Refer to [Figure 19](#).

For systems installed below pool level with a booster pump, a swing-type check valve may be used instead of a 3-way motorized valve. Refer to [Figure 19A](#).

FIGURE 19: System Below Pool Level with 3-way Valve

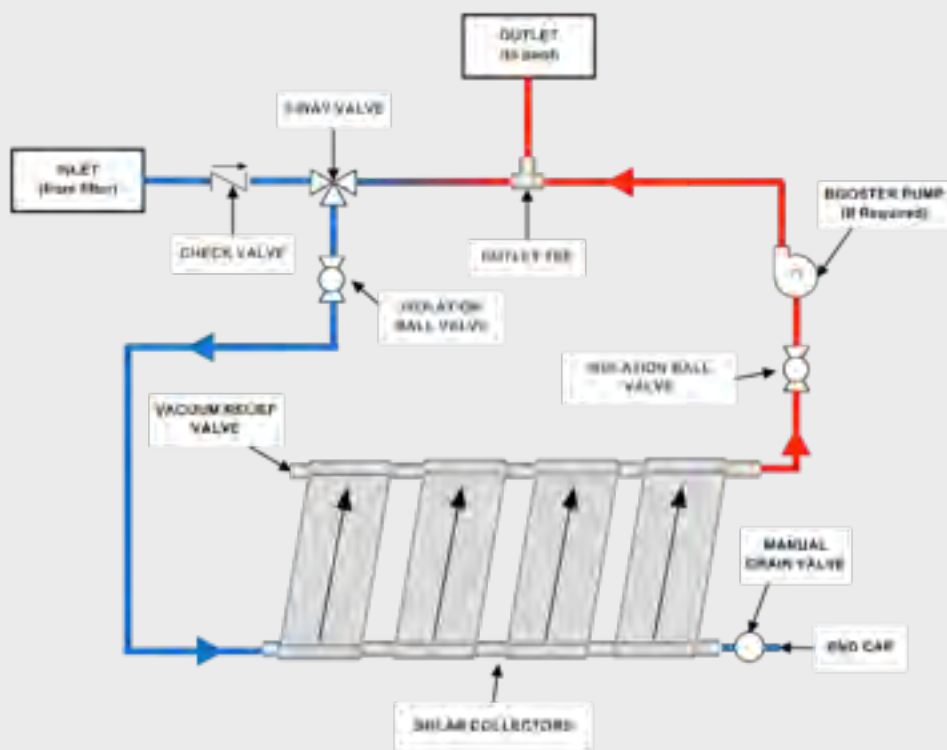
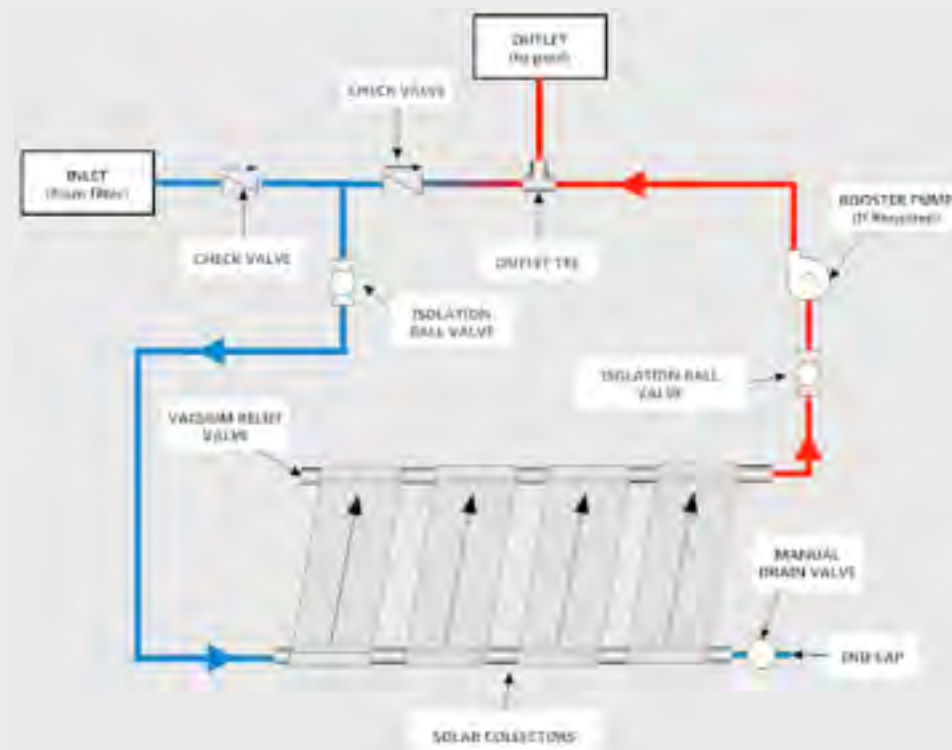

Figure 19A System Below Pool Level without 3-way Valve



Control Systems

Contents

1. Manual System
2. Automatic Control System
3. Booster Pump System

Manual System

- Some systems employ a manual control valve to divert the flow of water thru the solar collectors, though this may reduce the overall heating capacity of the system. A manual control valve usually consists of a non-positively sealed 3-way valve used in place of the motorized valve as shown in [Figure 12](#) Water continuously flows through the solar collectors when the filter pump is on, but can be diverted manually by the pool owner if the pool becomes too warm or during extended cloudy weather. During a threat of freezing conditions it can also be diverted, by first shutting off the pool pump, allowing the collectors to drain, diverting the 3-way manual valve to the “bypass collector” position and shutting the isolation valve on the collector feed line. A lower End Cap on the collectors or any of the connecting hoses can be removed to make sure there is no standing water in the collectors. The filter pump can then be restarted to allow for normal pool filtration.

Refer to [Figure 13](#).

Refer to [Manual Systems Start-Up](#).

Automatic Control System

- The performance of a solar pool heating system can be maximized with the use of an electronic control and motorized 3-way valve. The control activates the motorized valve and either sends water thru the collectors for heating (or nocturnal cooling) or automatically bypasses the collectors when the pool is warm enough or insufficient sunlight is available. Refer to the manufacturer's instructions included with the automatic control you use.
- During normal operation of the system when the 3-way valve is in the 'bypass collector' position all the water in the collectors should drain back through the 3-way valve (non-positively sealed) when the filter pump shuts off. An alternate way to protect against sudden freezes can be accomplished by running a bypass line (1/8"-1/4", 3-6mm) between the collector feed and return line above the isolation valves, if any. It is possible that a small amount of water may be present in the collectors when a non-positively sealed 3-way valve is used and the filter pump is on. If a positively sealed 3-way valve is used, a bypass line as mentioned above is mandatory to allow for collector drainage.

Refer to [Figure 12](#).

Refer to [Automatic Control Systems Start-Up](#).

Booster Pump System

- In some cases, the pool filtration pump may not be able to circulate water at a high enough flow rate to allow for proper collector operation. If so, it may be necessary to replace the filter pump with a larger one or add a booster pump. If the pump size is increased, it may also be necessary to upgrade the filter to one with greater flow ratings.

Refer to [Figure 16](#), [Figure 19](#), and [Figure 19A](#).

- If the system is installed on a commercial or public pool, local codes may require positive isolation valves in the collector feed and return lines. See [Figure 16 A](#) for the proper placement of the isolation check valve and pressure relief valve.

Other Equipment

Contents

- 1.Pool Cleaners
- 2.Chlorinators/ Salt Generators
- 3.Supplemental Heaters

Pool Cleaners

Some pools employ an automatic pool cleaner. This should be plumbed before the control valve to assure positive flow to the cleaner at all times. Unless the control system has a cleaner time delay.

Refer to [Figure 12B](#).

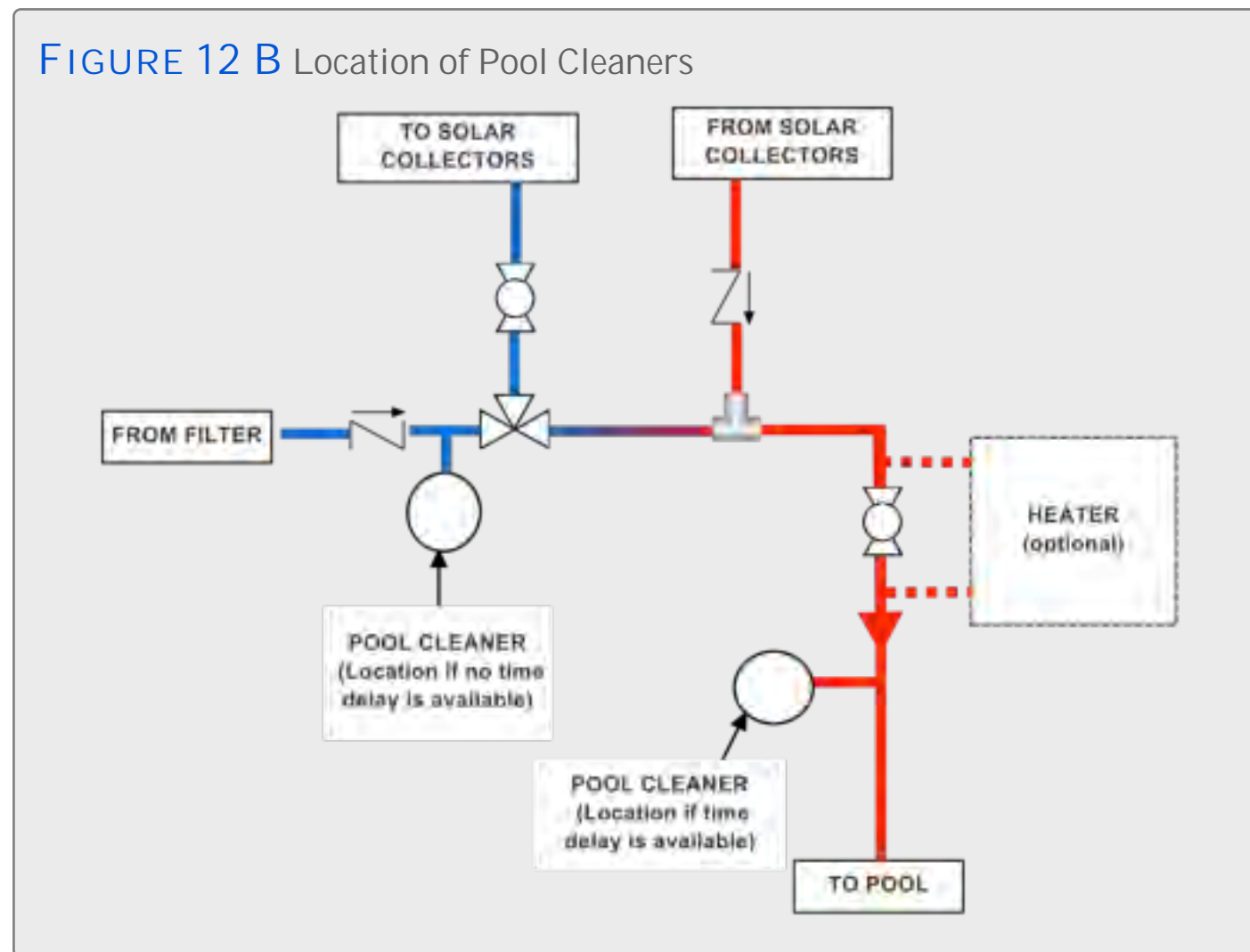

Chlorinators/Salt Generators

If the pool uses an automatic chlorinator, this should be plumbed after the outlet tee on the return to the pool.

Refer to [Figure 12 C](#).

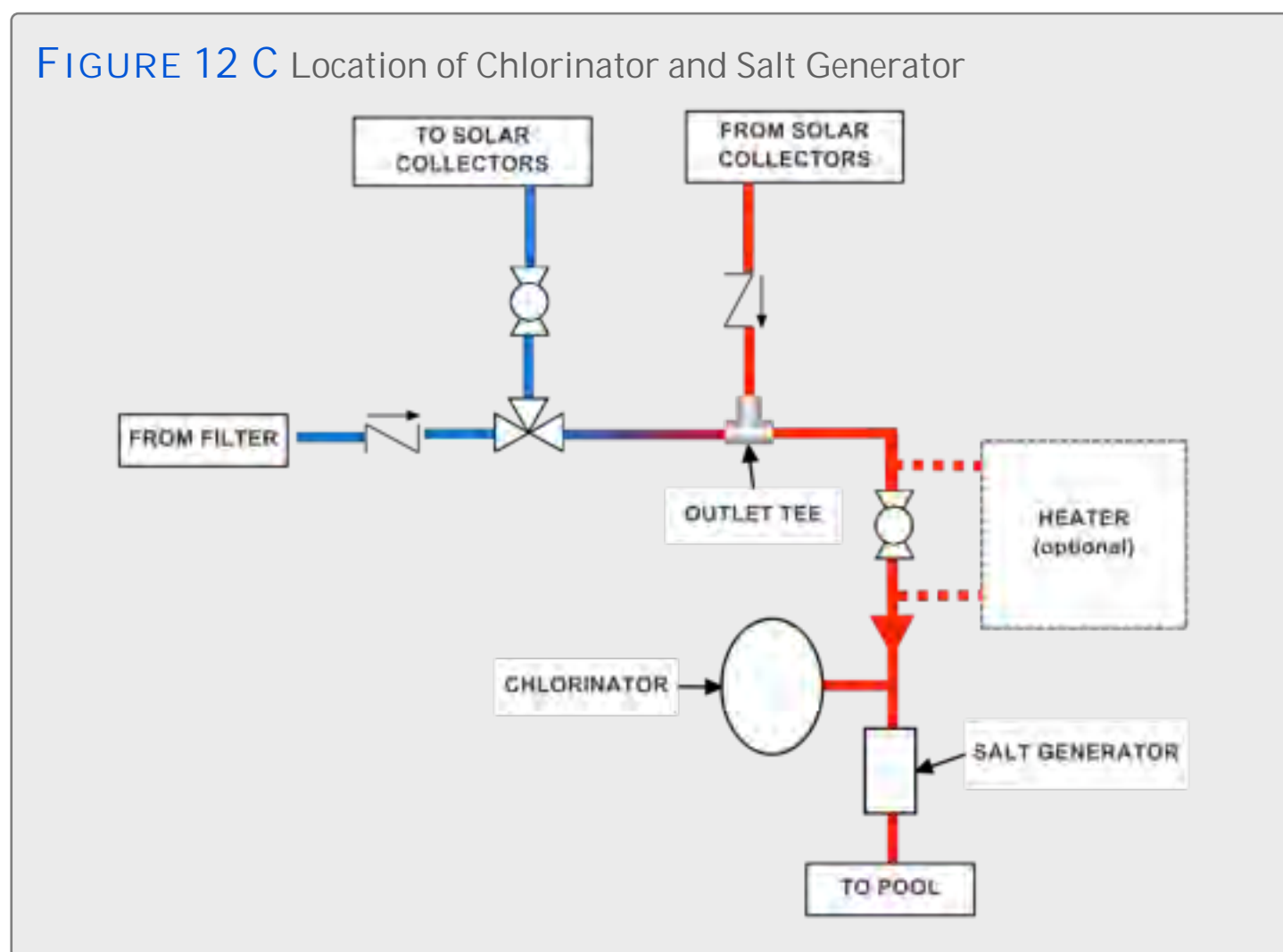

Supplemental Heaters

Supplemental Gas, Oil-Fired, or Electric Heaters

- It is desirable to pipe the standby heater in a bypass loop. Refer to [Figure 12](#), [Figure 13](#), or [Figure 16](#). Fuel-fired heaters often create a large pressure drop. By placing a heater in a bypass loop, pump size, and electrical energy requirements may be reduced.

Refer to [Figure 12D](#).

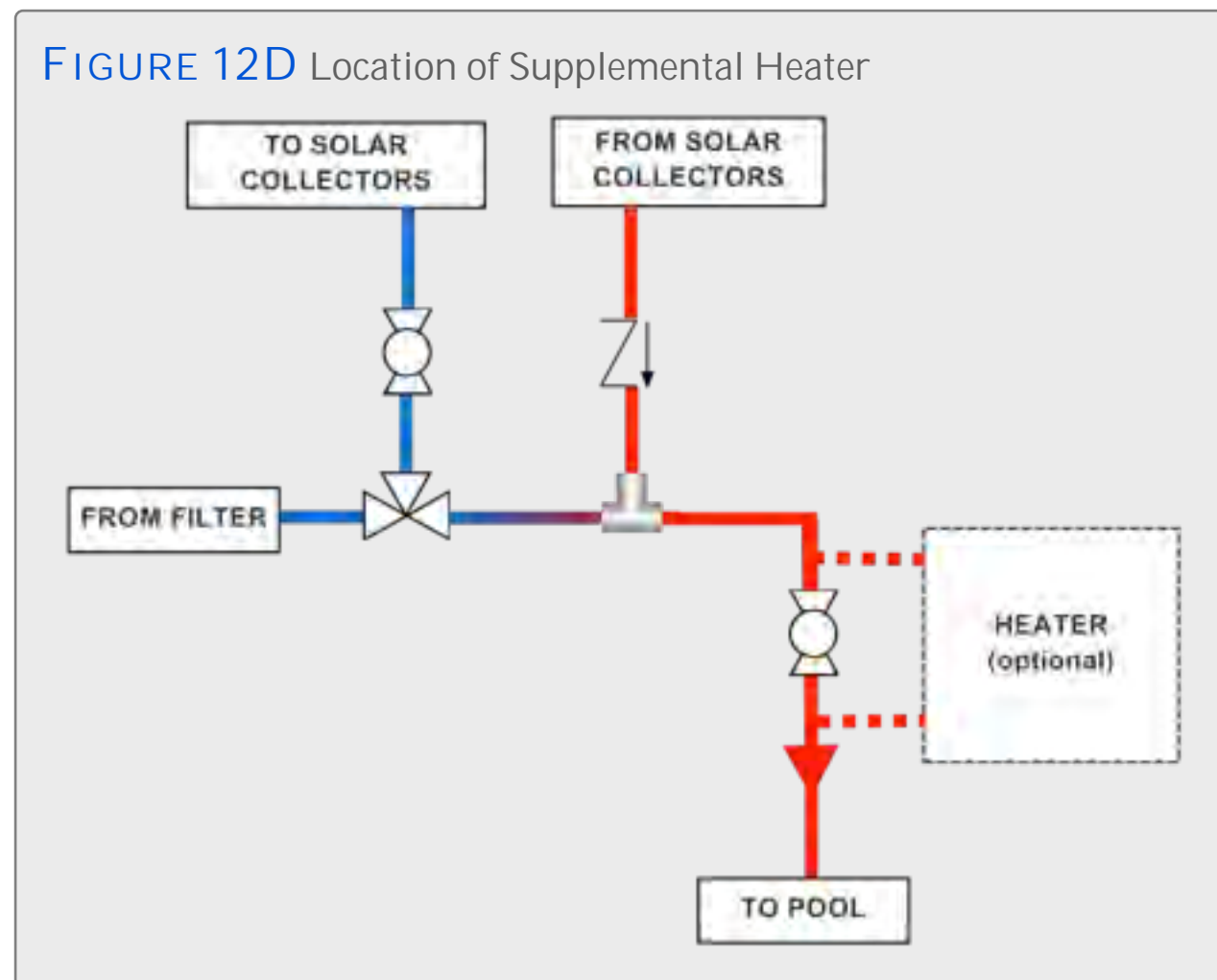

Return to: [Chapter 5 Home Page](#).

System Start-Up, Testing, and Troubleshooting

Contents

1. Checking for Operation
2. Manual Control Systems
3. Automatic Control Systems
4. Vacuum Relief Valve Test
5. Flow Rates Test Methods

Checking for Operations

Each time the solar system cycles on, there are a few things to watch for:

- 1) Air will initially be purged into the pool. This may last several minutes.
- 2) The filter pressure will increase slightly and remain elevated as long as pool water is flowing through the solar collector.

Manual Control Systems

- To test collector operation, follow either the flow-rate or temperature-rise procedure. Divert water through the collectors. Turn on the pump and either observe flow rate or temperature rise. The flow rate or temperature rise would be the same as that specified in the “System Start-Up and Test” section. If it is not, then check for the indicated probable causes and make necessary corrections.

Refer to [Manual Control Systems Overview](#).

Automatic Control Systems

- To check out an automatic system for proper operation turn on the filter system. Set the temperature control to its highest level. Switch the control to the "Manual ON" mode. The "Heating" or "Solar ON" light should come on. The 3 way valve will then be sending water thru the collectors, and air will be purged out of the collectors into the pool return line for several minutes, and should then clear. The collectors should feel uniformly cool to the touch. Switch the control to the "Manual OFF" mode. The corresponding light will go off and the 3 way valve will be sending water directly back to the pool, bypassing the solar collectors. After about 5-10 minutes, feel the solar collectors again. They should have begun to warm up. Now switch to "Auto" or "Solar Enabled". If the sun is still shining on the solar collectors, the "Heating" or "Solar ON" light should go on again. Adjust the temperature control lower.
- When you reach the actual temperature of the pool water, the light will turn off. The "Heating" or "Solar ON" light will go off again. Move the temperature control to the desired comfort level. The "Heating" or "Solar ON" light will go back on. For more detailed information on the system startup, trouble shooting and valve/control installation, follow the manufacturers' instructions included with the automatic control system.

Refer to [Automatic Control System Overview](#).

Vacuum Relief Valve Test

- When the solar system is first turned on, air in the collectors will be expelled into the pool and bubbles will appear. The appearance of bubbles in the pool should stop after a few minutes.
- If, after a few minutes, bubbles continue to be discharged at the return to the pool, remove the Vacuum Relief Valve(s) and replace it with an End Cap. Relocate a Vacuum Relief Valve to a position in the inlet piping which is at a height of approximately 3/4 of the elevation of the collectors above the pool. Refer to [Figure 2](#).
- A quicker alternate method is to first try to reverse the End Cap and the Vacuum Relief Valve on the collector array to see if this stops the bubbles in the return lines. This is a lot quicker than cutting in a tee in the supply pipe.

Flow Rates Test Methods

1. Touch Method

- With the system running and the sun shining, all collectors of the system should be uniformly cool to the touch, and the system will be operating at optimum performance.
- If the system has been installed according to these instructions this optimum performance condition will now exist. Systems with rows of collectors of unequal size, but fitted with balancing valves, may now be adjusted. Open all balancing valves completely and let the system run for several minutes. The row(s) which feel(s) warmer to the touch than the other(s), is currently receiving less flow than it should for optimum performance. Throttle the valve(s) of the other (cooler) row(s) step-by-step, each time waiting for a few minutes, and check the temperature. Once all rows feel uniformly cool, the system is balanced and operates at optimum performance. Should unexpected problems be encountered, the flow rate must be checked out more thoroughly.

2. Flowmeter

- The preferred system test method is flow rate. This is also the easiest and quickest method. To check flow rate, install a flow meter in the inlet line to the collectors (follow installation instructions provided with the flowmeter).

Flow Rates Test Methods Cont.

3. Temperature Rise Test Method

- An alternate test method is temperature rise. To prepare the system for testing, obtain two accurate thermometers. One of these thermometers is installed in the outlet line from the collectors as shown in [Figure 12](#). The other is used to check the temperature of the pool water, to compare it with that of the water leaving the solar collectors. Before installing the thermometer in the outlet line, immerse both thermometers in the pool water for several minutes to compare the temperature readings. If they are not identical, make a notation of the difference and add or subtract (as appropriate) this difference to or from the reading taken while you are testing. This is necessary in order to provide an accurate indication of the temperature rise of the water passing through the solar collectors.
- Turn the pump on and move the flow switch to the “Manual ON” position. Observe valve action...it should divert water through the collectors. After flow through the collectors has continued for a least fifteen minutes, compare the pool water temperature with the temperature of the water flowing through the outlet line. On an average sunny day, with the air temperature approximately 70°F (40°C) the water leaving the collectors should be 1° to 7°F (1° to 4°C) higher than that in the pool. If the water rise is greater than this, insufficient water is flowing through the collectors. This may be caused by a clogged filter, undersized piping, too many elbows in the piping or an inadequate pump. It is important that the temperature rise through the collectors be kept as low as possible in order to deliver the maximum amount of heat to the pool.

Return to: [Chapter 6 Home Page](#).

Maintenance

Contents

1. Pool Service and Maintenance
2. Cold Weather Operation/ Winterizing Procedures
3. Annual Inspection

Pool Service and Maintenance

It is advisable to bypass the solar collectors when either backwashing your filter or adding Diatomaceous Earth (DE). This prevents the possibility of any DE or other debris from passing through the solar system as well as any other pool equipment downstream of the filter. When the backwashing cycle and/or the adding of DE is complete, run the filtration system for 10-15 minutes before returning your solar heating system to operation. If you have an automatic pool cleaning system with its own pump, there may be several precautions that you need to take depending on what type of system you have. These precautions prevent the air that is initially purged from the solar system from possibly damaging pool cleaning equipment during the turning on cycle of your solar system.

Manual Control- do not start the flow of water through the solar collectors while the pool cleaning pump is running. Allow the air to be purged from the system and then activate your pool cleaning system.

Automatic Systems- if your automatic control system is not equipped with a timed pool cleaner delay cycle, it will be necessary to run your pool cleaner in the early morning and turn it off before your solar system comes on or turn it on in the late morning, well after your solar system normally cycles on. If you manually vacuum your pool, bypassing the solar collectors at this time will provide you with full power for better vacuuming performance.

Return to: [Chapter 7 Home Page](#); [Annual Inspection](#).

Cold Weather Operation/Winterizing Procedures

- If installed according to this manual, the solar collectors should drain automatically each time the pump cycles off. There are no special requirements for winterizing the solar collectors. The pool piping should be winterized as per your normal practice.
- In some areas, pool owners operate their pools throughout the winter although light freezing conditions may occur. The accepted procedure for avoiding freezing of the pool piping and filtration system has been to continuously circulate the water.
- When solar heaters are used on a pool under these conditions, anti-freeze precautions should be taken. Aquatherm collectors are not normally affected by 40°F freezing. In order to protect the collectors as well as appurtenant components such as End Caps and pipe fittings and against unusual or severe freezing conditions, one of the following two procedures should be followed when freezing weather is imminent.
 1. Turn circulating system off and allow solar collectors and piping to drain. Isolate collectors with gate or ball valve in collector feed line and a check valve in the collector return line. Switch the solar control to "OFF" or "Solar Disabled". The pool filtering system may then be turned back on. When freezing conditions have passed, open isolation valve(s) and switch the solar control to "AUTO" or "Solar Enabled".
 2. If isolation valves are not installed in the system, switch the solar control to the "Manual ON" position so that water circulates through the collectors. When freezing conditions have passed, switch the solar control to "AUTO" or "Solar Enabled". **THIS METHOD IS NOT RECOMMENDED WHERE TEMPERATURE LEVELS MAY DROP SEVERELY.**

Return to: [Chapter 7 Home Page](#).

Annual Inspection

Annual Service Collector Clamps:

- In particularly hot climates the clamps which are used to connect the solar collectors may become loose. If you notice leaks around the hose couplings, use a nutdriver to tighten clamps. Do not tighten to the extent that the pipe collapses or the clamp gears strip.

Note: Also see [Pool Service and Maintenance](#).

Return to: [Chapter 7 Home Page](#).

Collector Repair

Contents

1. Repair Plug
2. Screw Method

Repair Plug

The following instructions are for using [Collector Repair Plug](#), Part # 30143, in order to stop a leak in a collector. Each leaking tube will require two plugs.

- Locate the leak and mark the tube to be plugged.
- With the pump turned off; using a sharp cutting tool, cut a 1" section out of the tube approximately 2" away from the header. Repeat on the opposite side of the tube. NOTE: CUT AWAY FROM THE HEADER REMOVING THE TOP HALF OF THE TUBE. BE CAREFUL NOT TO CUT ADJACENT TUBES.
- Wet the cut out area of the tube and the plug with water. DO NOT USE A LUBRICANT.
- Insert the plug towards the header, narrow side first, use a #0 Phillips Head Screwdriver to completely insert the plug into the tube. Remove Screw Driver with a twisting motion. Repeat this process with the second plug on the opposite side of the collector.
- After both plugs have been inserted; test that a seal had been achieved by turning the system on.

Return to: [Chapter 8 Home Page](#).

Screw Method

This method allows for an easy and permanent on site repair of a collector if the leak is at the header where the riser tube is welded to the header, or a leak is anywhere in the riser tube if the system is located in areas experiencing frost.

- Using a sharp utility knife, very carefully cut away approximately 1" of the tube at both headers.
- Drive a #10 - #12 sheet metal screw, preferably stainless, into the hole in the header.
- The screw must be between 1/2" and 3/4" long. DO NOT OVERTIGHTEN!
- If the screw strips out, or if the repair leaks, use a larger screw. This repair method will not void the collector warranty.

Refer to [Figure 20](#).

Appendix

Contents

[Figure 1](#): Mounting Components Diagram

[Figure 2](#): Assembly on Roof Diagram

[Figure 3](#): Outlet Header Bracket Location

[Figure 4](#): Outlet Header Bracket

[Figure 5](#): Installed Outlet Header Bracket with Hose

[Figure 6](#): Strap Bracket

[Figure 7](#): Termination Strap Bracket Assembly

[Figure 8](#): Termination Strap Bracket Assembly

[Figure 9](#): Strap Bracket with Strap

[Figure 10](#): Installed Vacuum Relief Valve

[Figure 11](#): Installed End Cap

[Figure 12](#): Automatic Plumbing System Schematic

[Figure 12A](#): Location of Collector By-Pass Check Valve

[Figure 12B](#): Location of Pool Cleaner

[Figure 12C](#): Location of Chlorinator and Salt Generator

[Figure 12D](#): Location of Supplemental Heater

[Figure 13](#): Manual Plumbing System Schematic

[Figure 14](#): Multiple Arrays Plumbed in Parallel

[Figure 15](#): High Wind Area Additional Strap Bracket Locations

[Figure 16](#): Booster Pump System for Outdoor Pools

[Figure 16A](#): Location of Optional Isolation Valves

[Figure 17](#): Reverse Return

[Figure 18](#): Direct Return

[Figure 19](#): System Below Pool Level with 3-way Valve

[Figure 19A](#): System Below Pool Level without 3-way Valve.

[Figure 20](#): Collector Repair

Figure 1: Mounting Components Diagram

FIGURE 1 Mounting Components Diagram

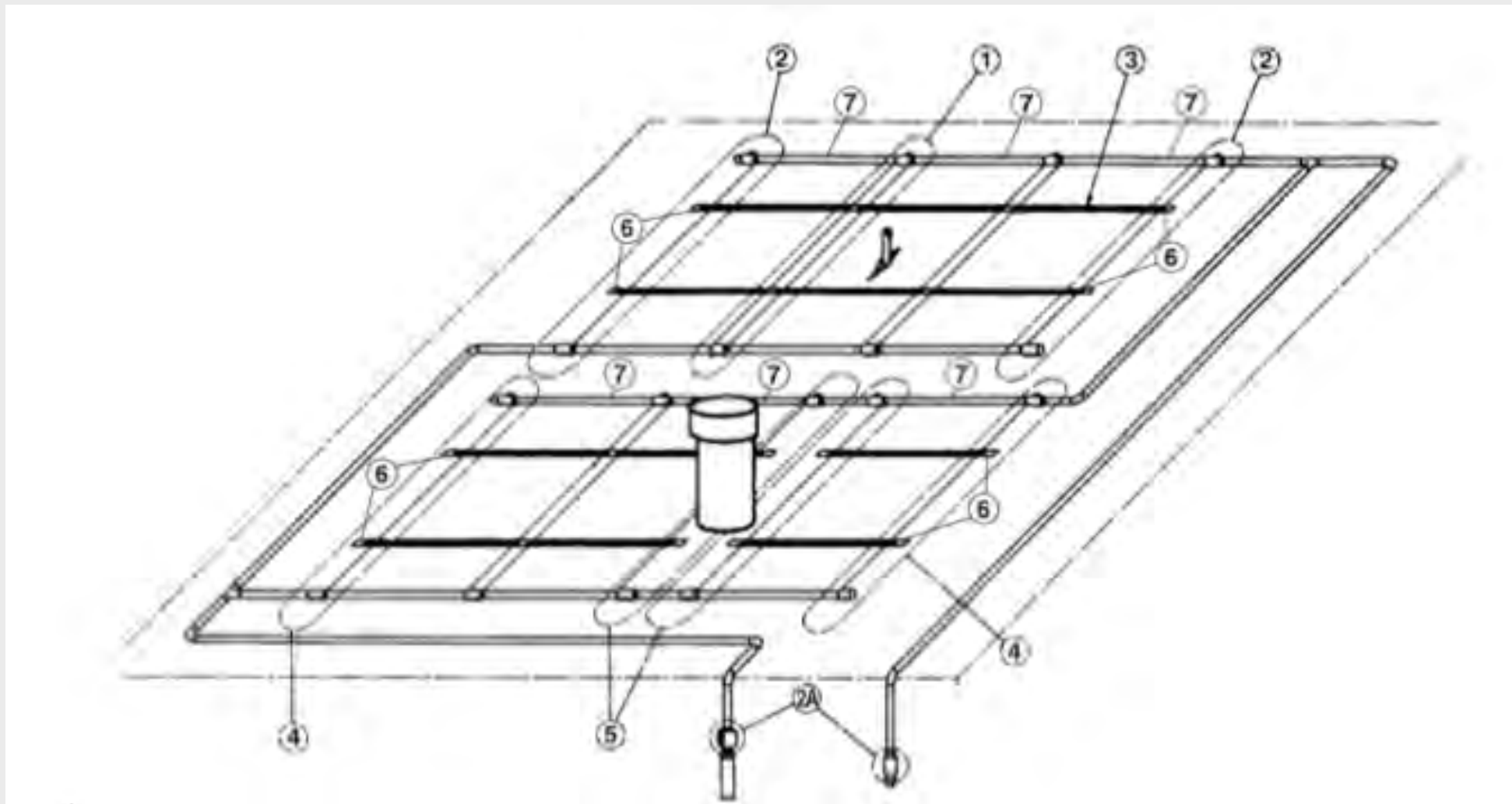

Figure 2: Assembly on Roof Diagram

FIGURE 2 Assembly on Roof Diagram

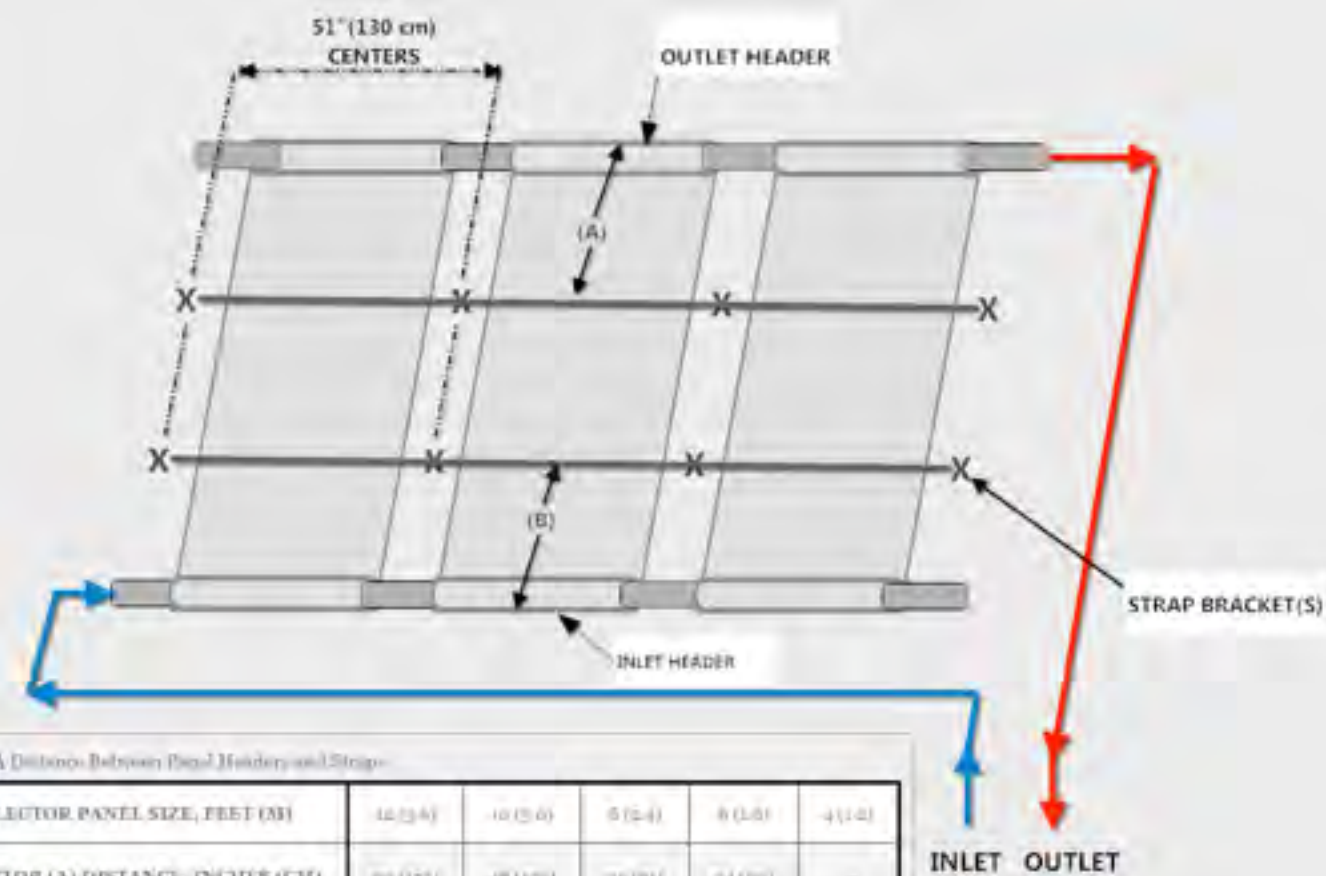

TABLE 2-A Distances Between Panel Headers and Straps

COLLECTOR PANEL SIZE, FEET (M)	4 (1.2)	4 (1.2)	6 (1.8)	8 (2.4)	4 (1.2)
COLLECTOR (A) DISTANCE, INCHES (CM)	76 (193)	48 (122)	36 (91)	24 (61)	-
COLLECTOR (B) DISTANCE, INCHES (CM)	20 (51)	26 (66)	26 (66)	30 (76)	20 (51)

ASSEMBLY ON ROOF DIAGRAM

Return to: [Mounting the Solar Collectors Overview](#); [Step Four](#); [Step Five](#); [Step Ten](#); [Step Eleven](#); [Vacuum Relief Valve Test](#); [Appendix Contents](#).

Figure 3: Outlet Header Bracket Location

FIGURE 3 Outlet Header Bracket Location



Return to: [Step One](#); [Appendix Contents](#).

Figure 4: Outlet Header Bracket

FIGURE 4 Outlet Header Bracket

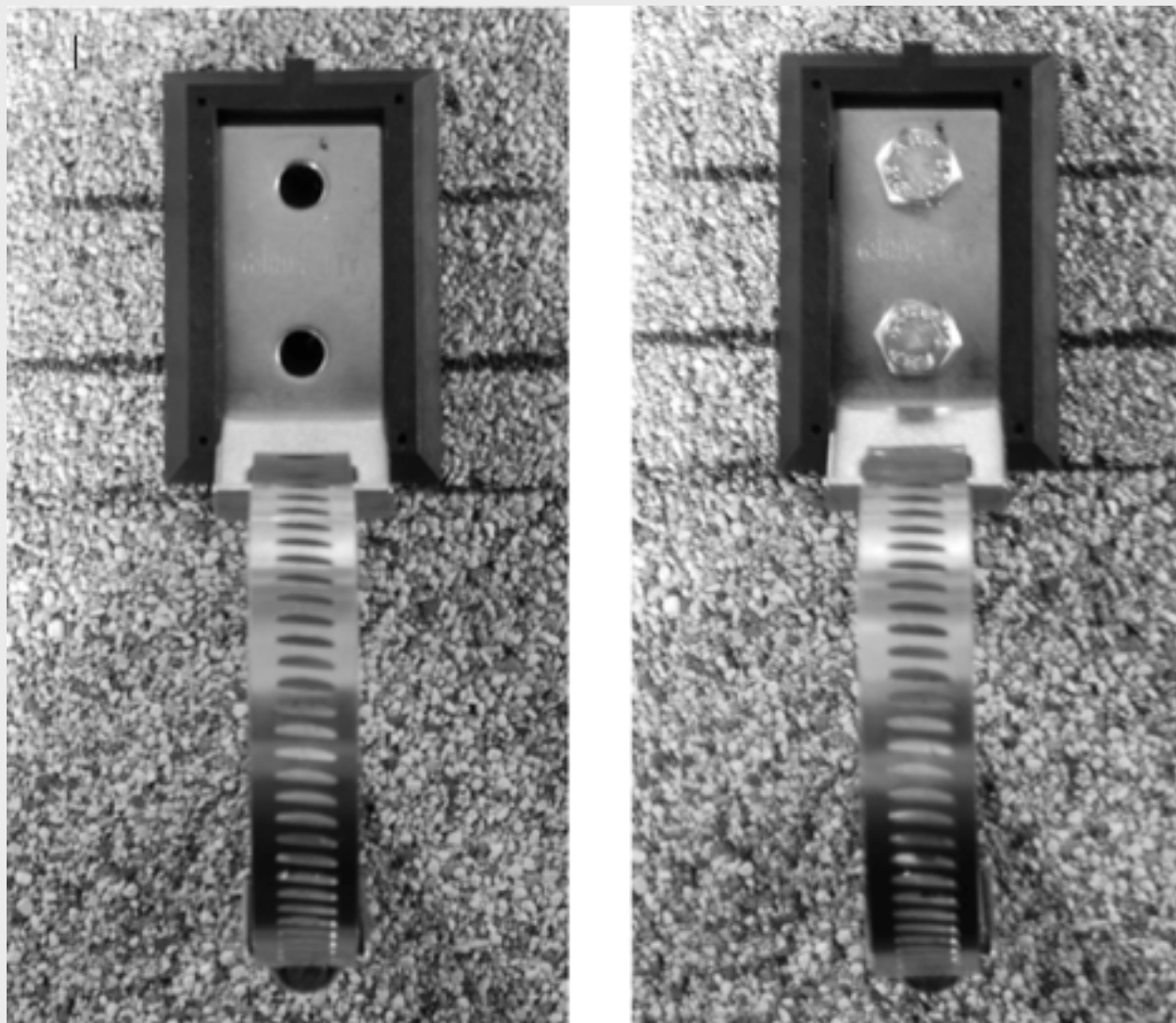

Return to: [Step Three](#); [Appendix Contents](#).

Figure 5: Installed Outlet Header Bracket with Hose

FIGURE 5 Installed Outlet Header Bracket with Hose



Return to: [Step Six; Appendix Contents.](#)

Figure 6: Hold-Down Strap Bracket

FIGURE 6 Hold-Down Strap Bracket

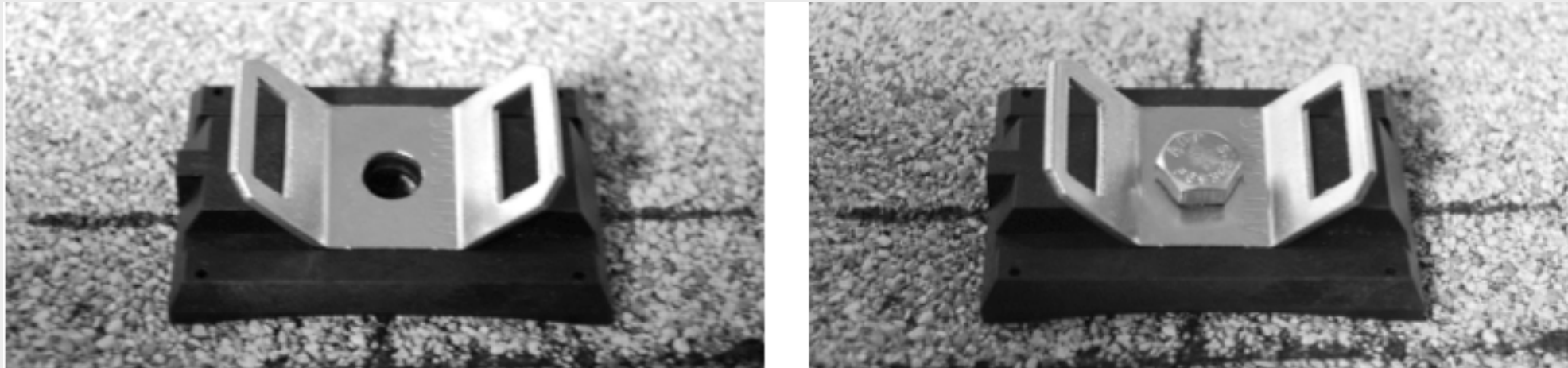

Return to: [Step Eight](#); [Appendix Contents](#).

Figure 7: Termination Strap Bracket Assembly

Return to: [Step Nine](#); [Appendix Contents](#).

FIGURE 7 Termination Strap Bracket Assembly



Figure 8: Termination Strap Bracket Assembly

FIGURE 8 Termination Strap Bracket Assembly

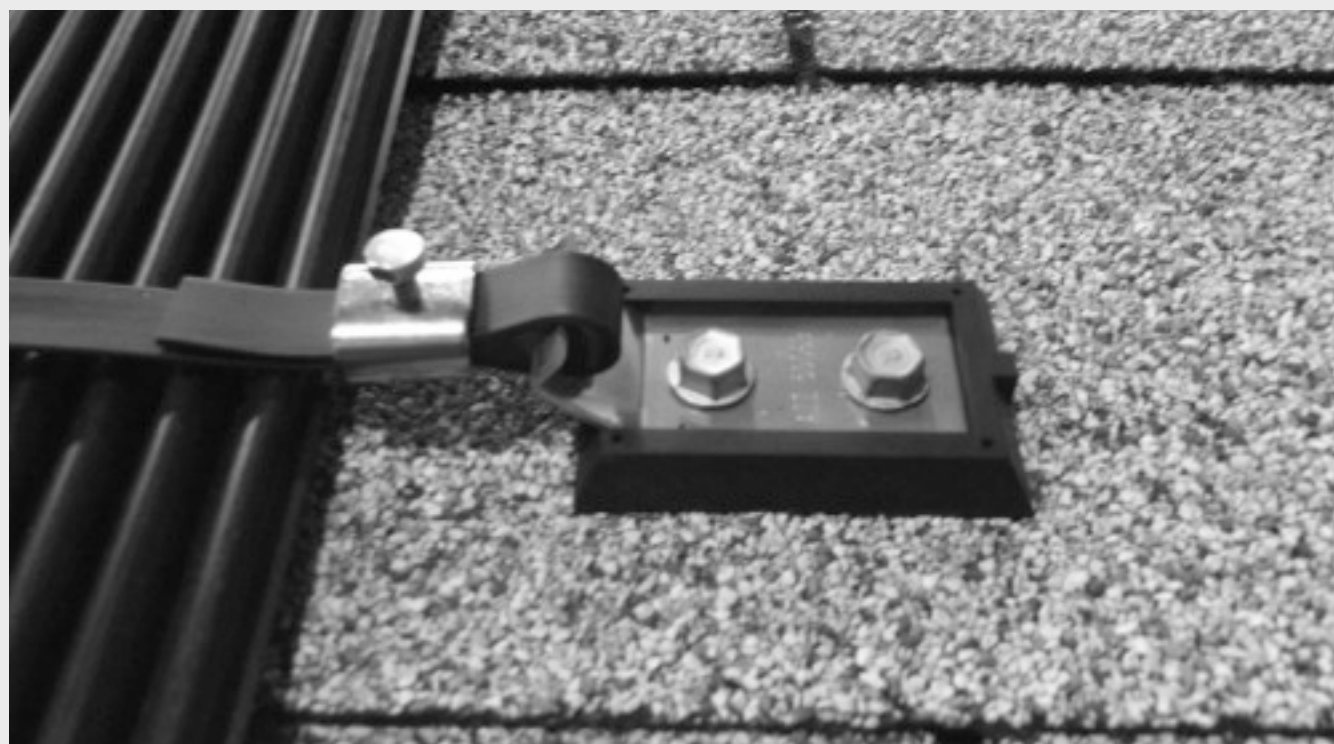

Return to: [Step Nine](#); [Appendix Contents](#).

Figure 9: Strap Bracket with Strap

FIGURE 9 Strap Bracket with Strap



Return to: [Step Nine](#); [Appendix Contents](#).

Figure 10: Installed Vacuum Relief Valve

FIGURE 10 Installed Vacuum Relief Valve



Return to: [Step Ten](#); [Appendix Contents](#).

Figure 11: Installed End Cap

FIGURE 11 Installed End Cap



Return to: [Step Eleven](#); [Appendix Contents](#).

Figure 12: Automatic Plumbing System Schematic

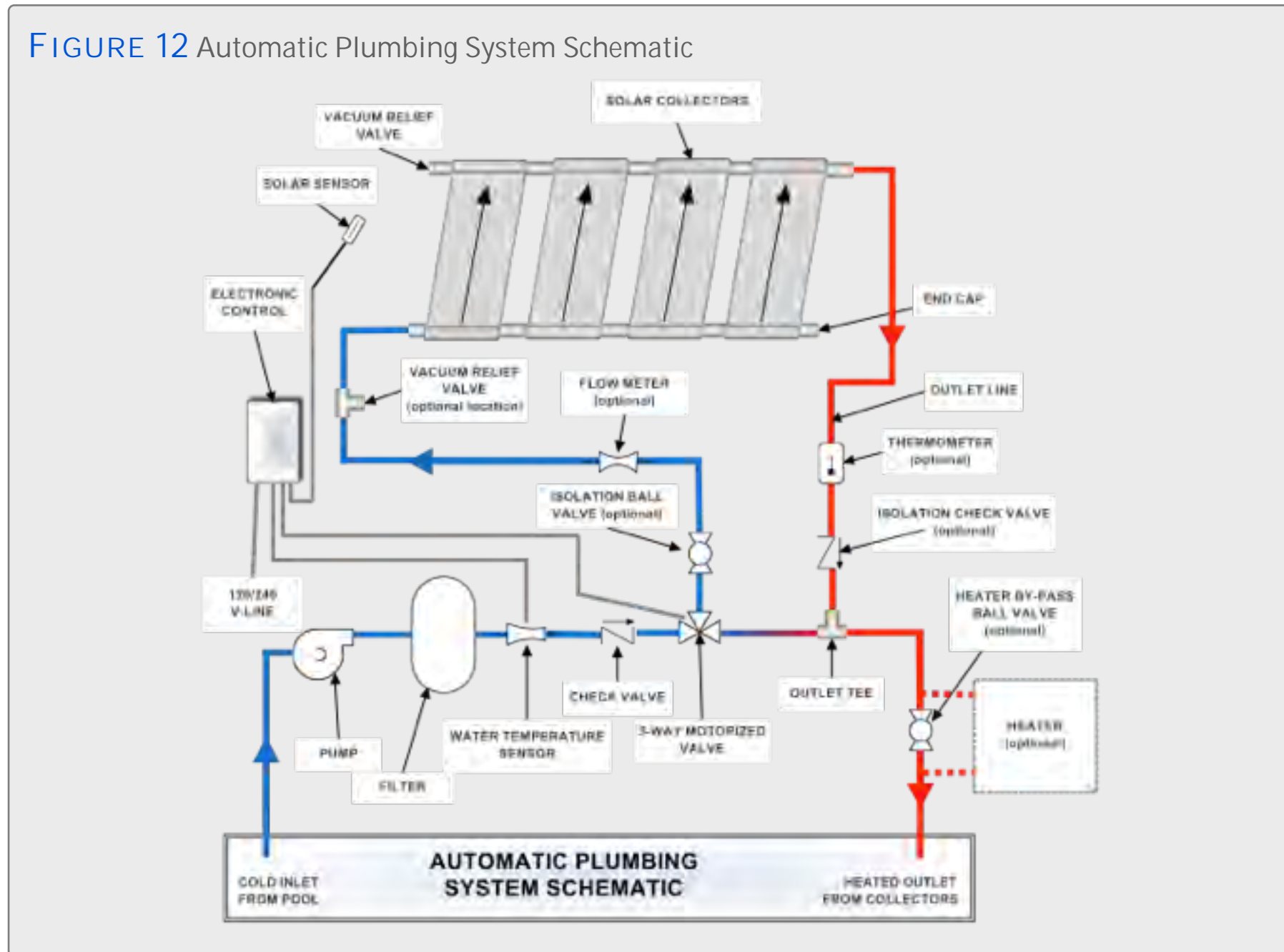

Return to: [Step Ten](#); [Step Eleven](#); [System Piping](#); [Manual Systems](#); [Automatic Systems](#); [Supplemental Heaters](#); [Flow Rates Test Methods Cont.](#); [Appendix Contents](#).

Figure 12 A: Location of Collector By-Pass Check Valve

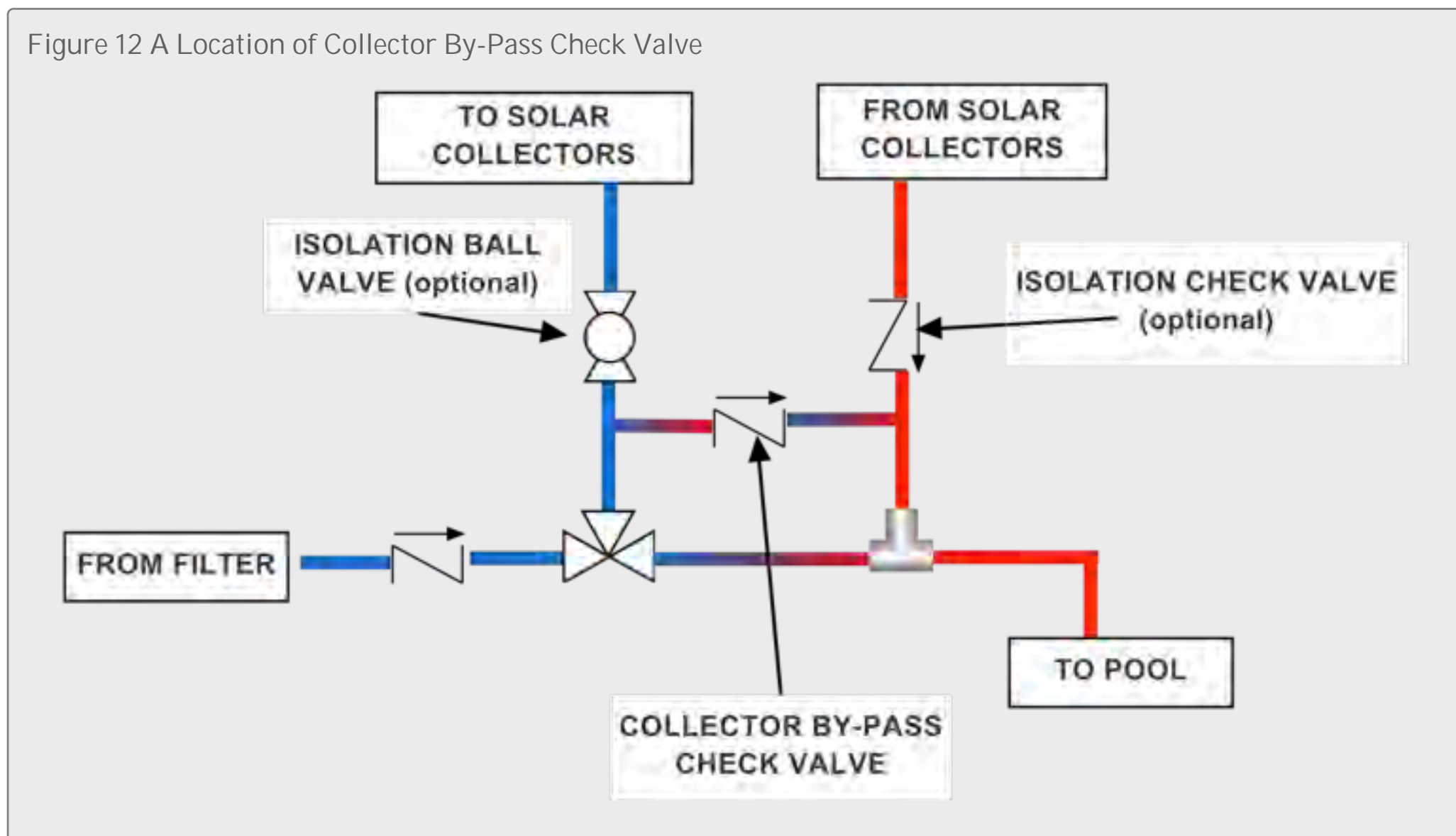

Return to: [Flow Rate](#); [Collector By-Pass Valve](#); [Appendix Contents](#).

Figure 12 B: Location of Pool Cleaners

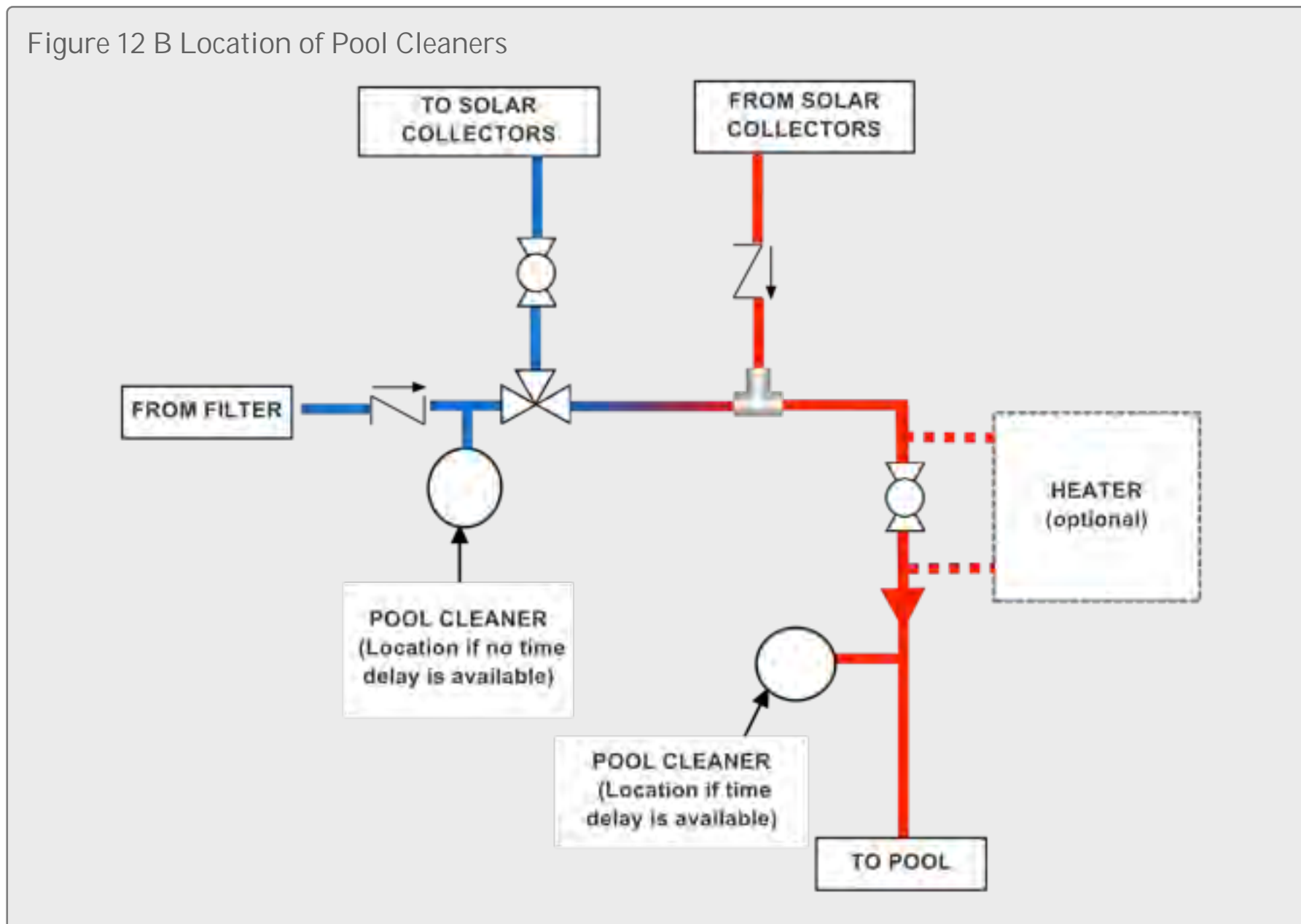
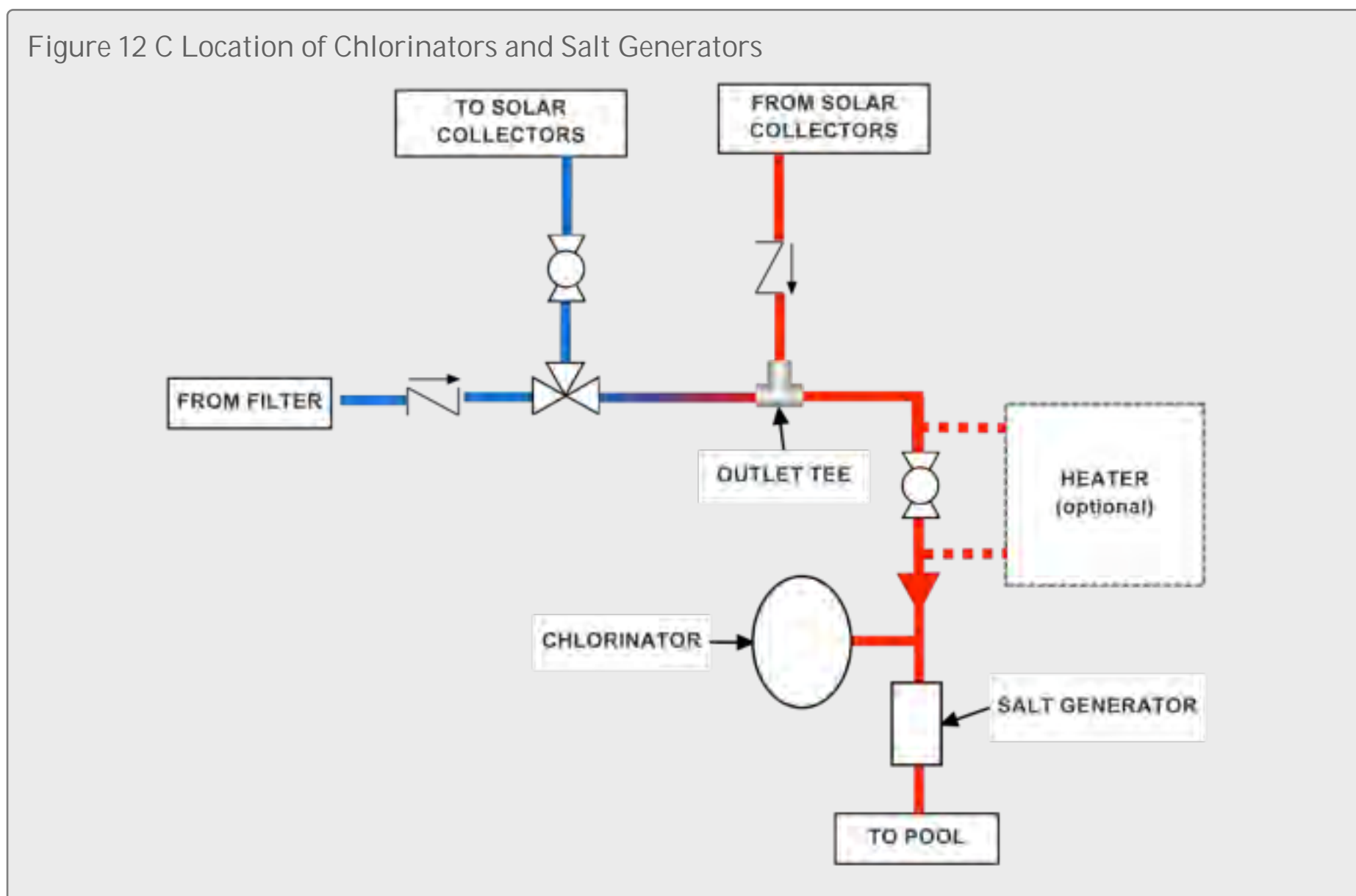

Figure 12 C: Location of Chlorinators and Salt Generators



Return to: [Chlorinators/Salt Generators; Appendix Contents.](#)

Figure 12 D: Location of Supplemental Heater

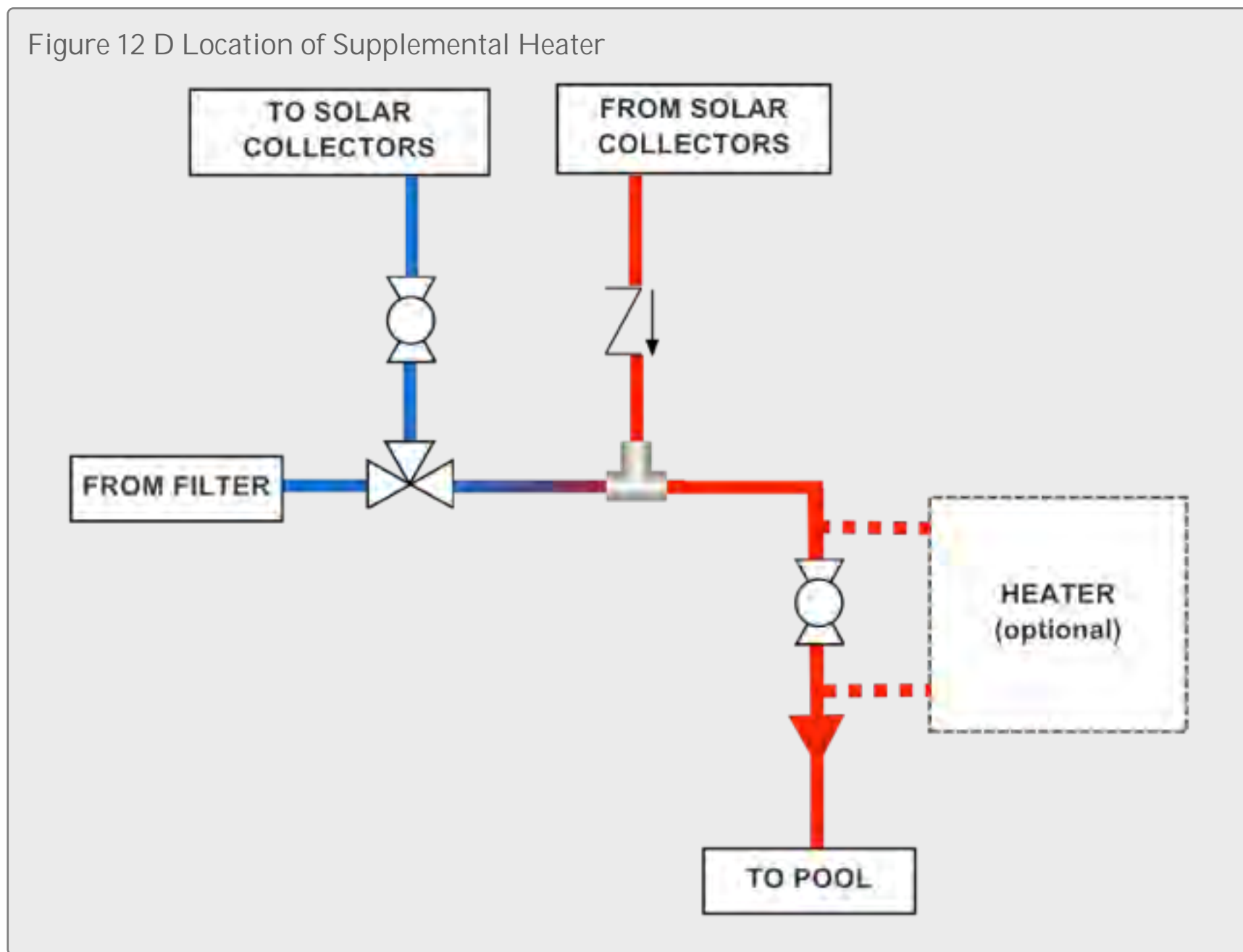
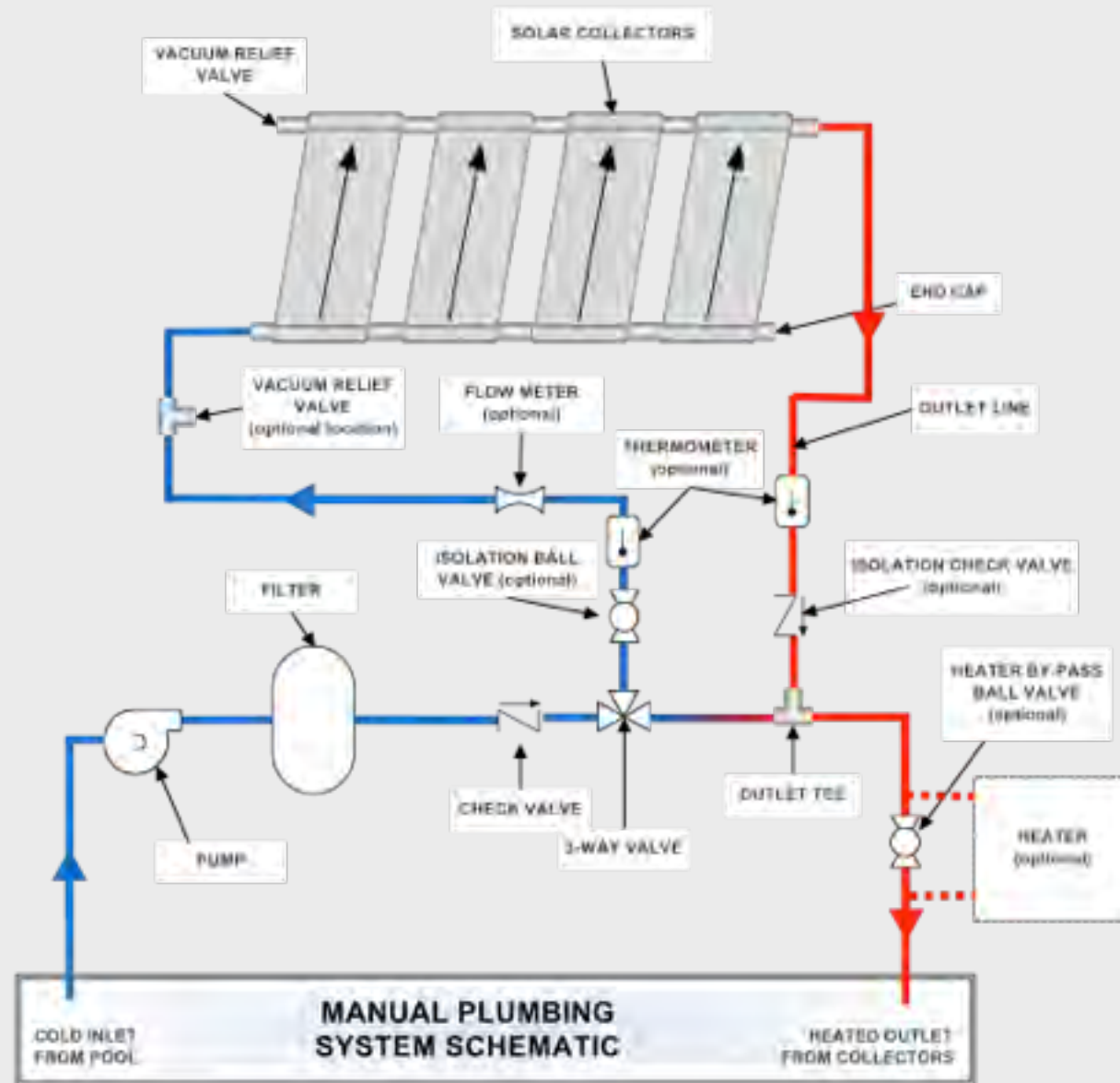

Figure 13: Manual Plumbing System Schematic

FIGURE 13 Manual Plumbing System Schematic



Return to: [Step Ten](#); [Step Eleven](#); [System Piping](#); [Manual Systems](#); [Supplemental Heaters](#); [Appendix Contents](#).

Figure 14: Multiple Arrays Plumbed in Parallel

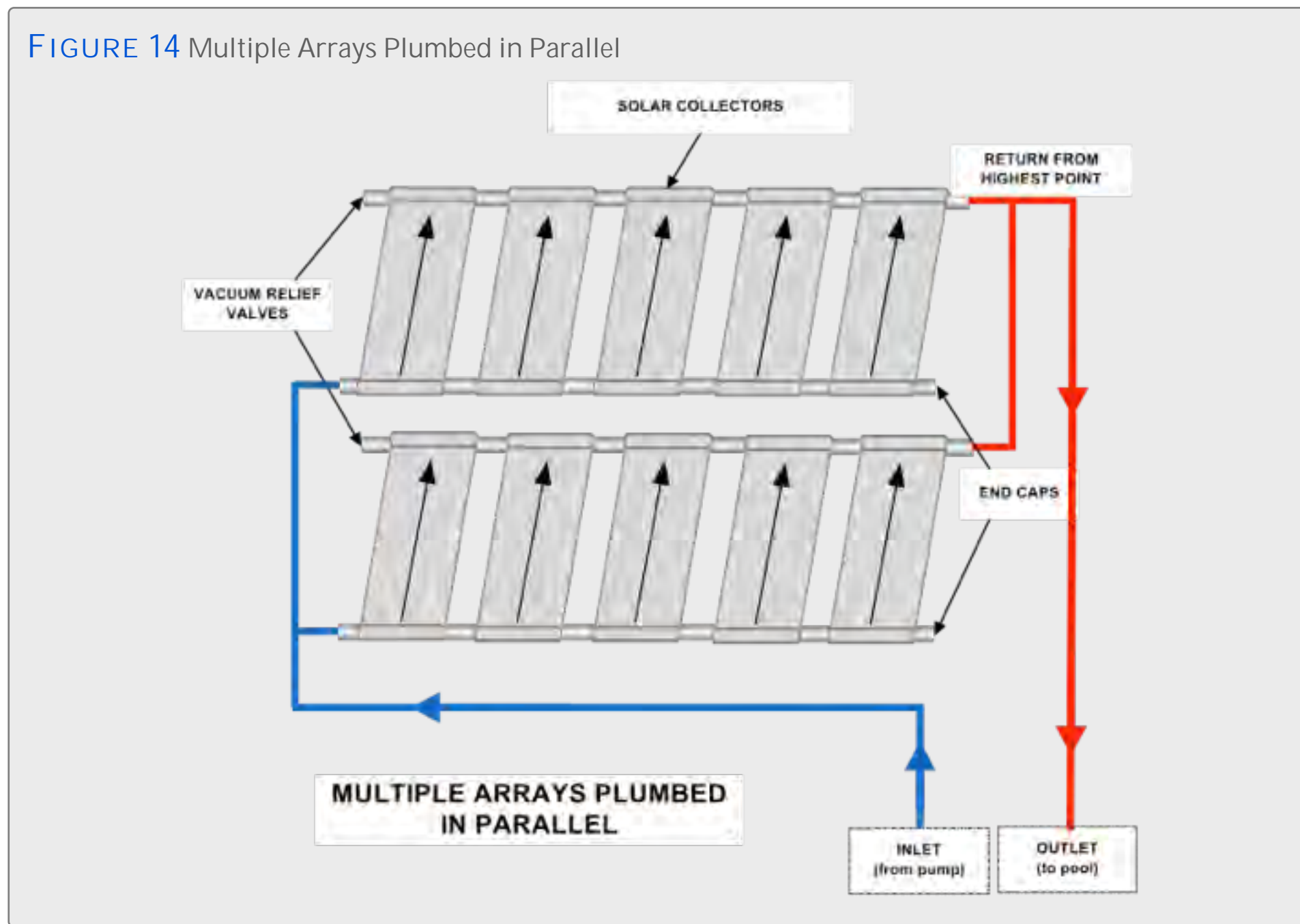

Return to: [Step Ten](#); [Step Eleven](#); [System Piping](#); [Special System Layouts](#); [Appendix Contents](#).

Figure 15: High Wind Area Additional Strap Bracket Locations

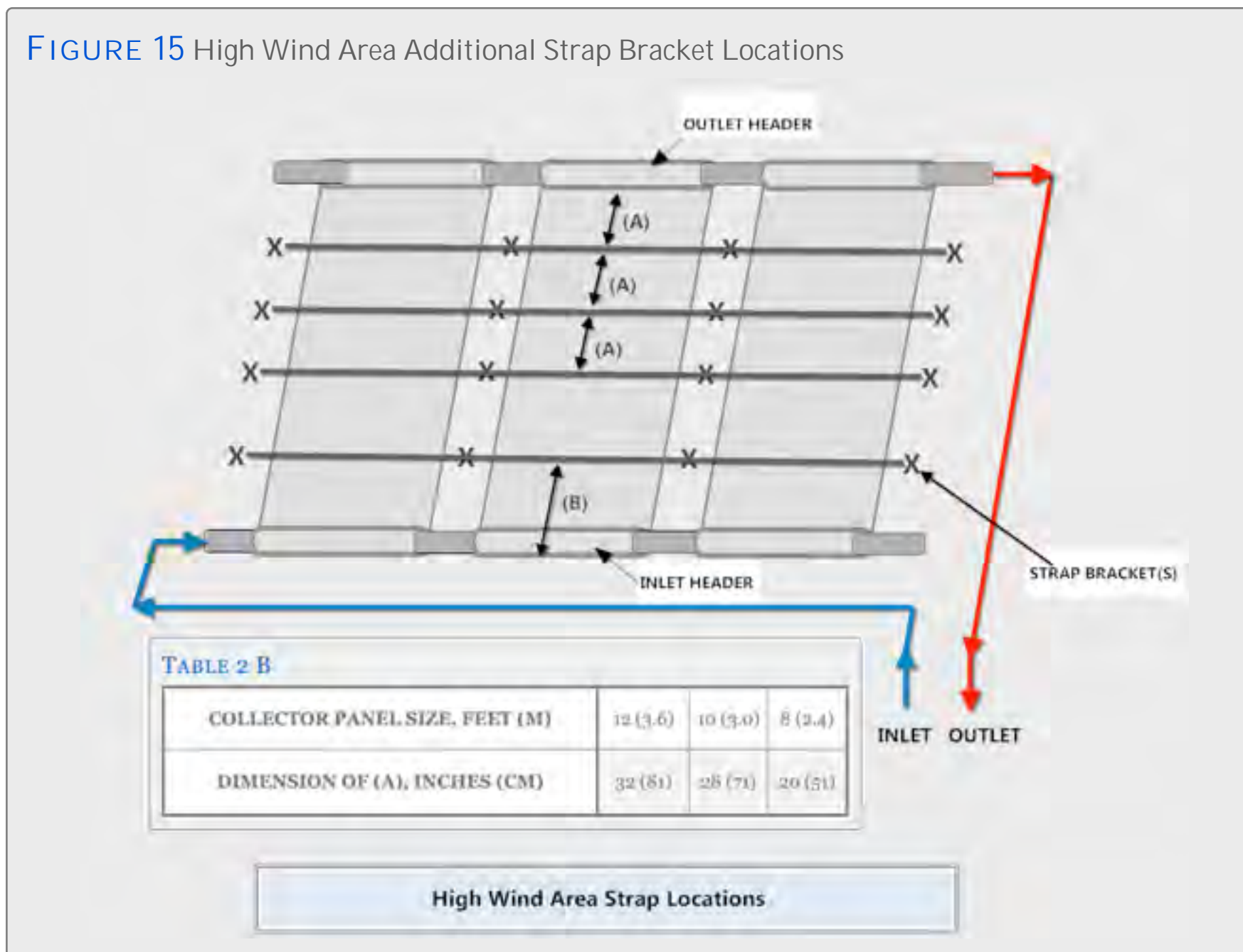

Return to: [Installation in High Wind Areas; Appendix Contents.](#)

Figure 16: Booster Pump System Diagram for Outdoor Pools

FIGURE 16 Booster Pump System Diagram for Outdoor Pools

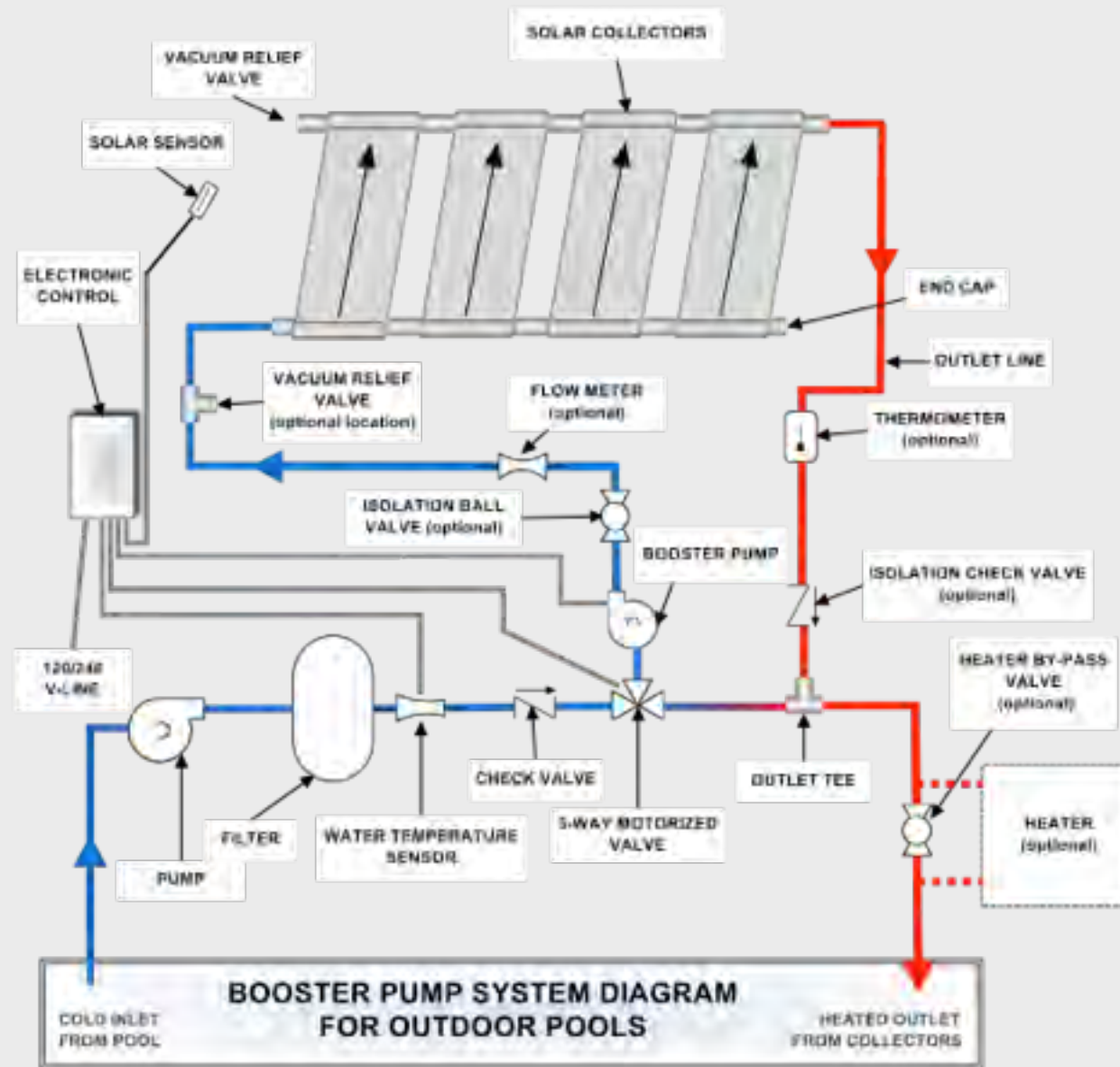

Return to: [Installation Over Roof Vent Pipes; Booster Pump Systems; Supplemental Heaters; Appendix Contents.](#)

Figure 16 A: Location of Optional Isolation Valves

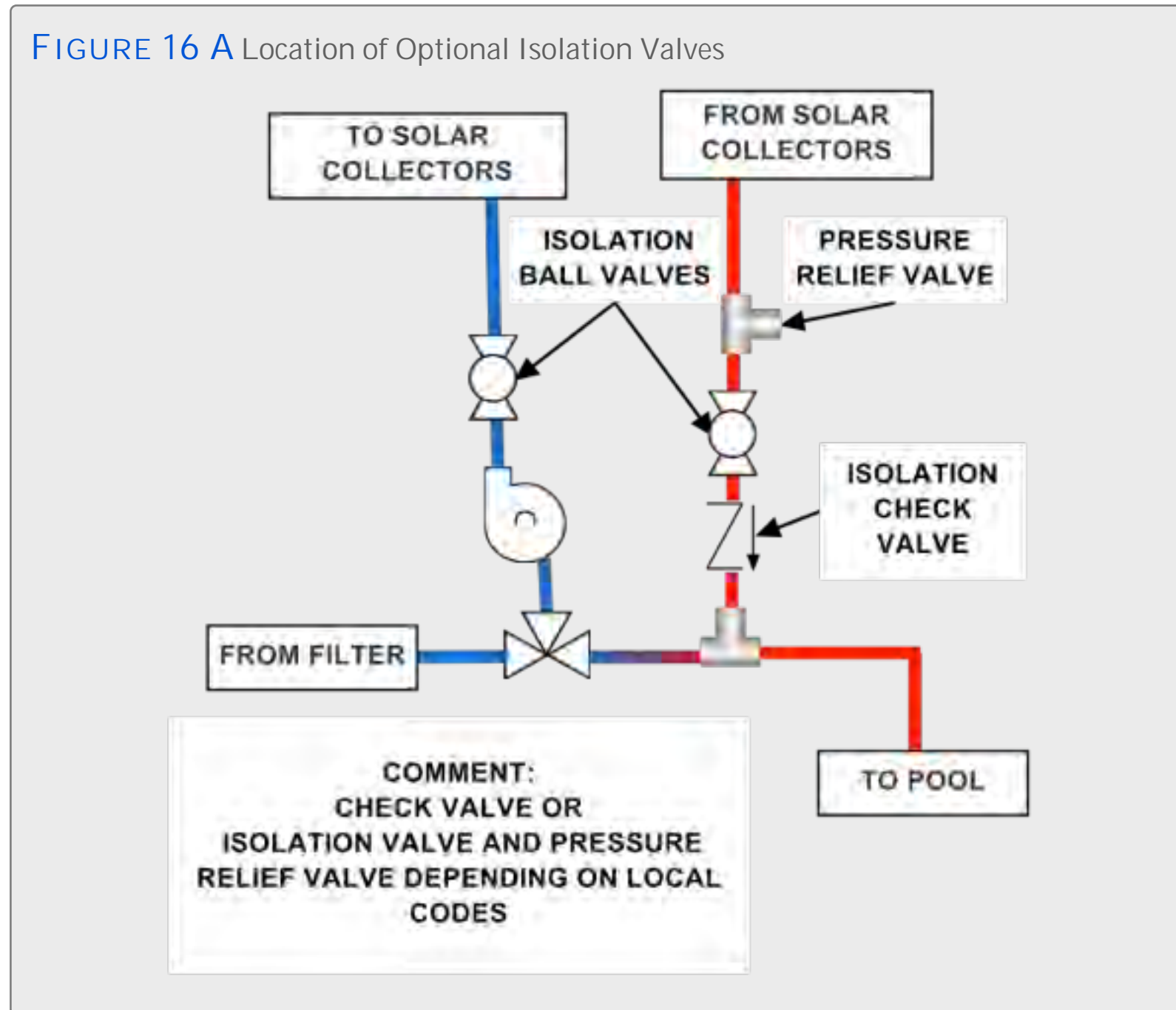

Return to: [Optional Isolation Valves; Booster Pump System; Appendix Contents.](#)

Figure 17: Reverse Return

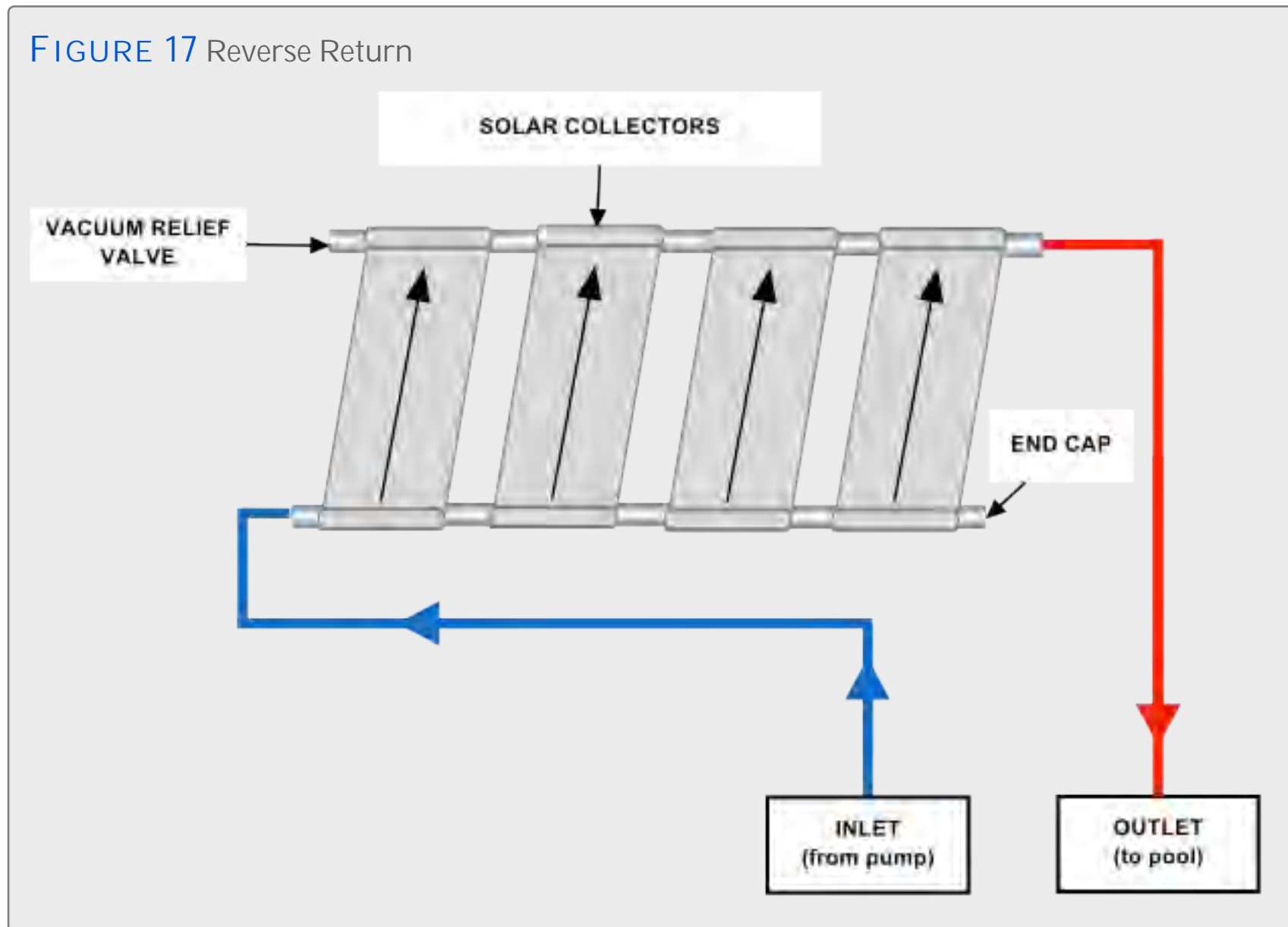

Figure 18: Direct Return

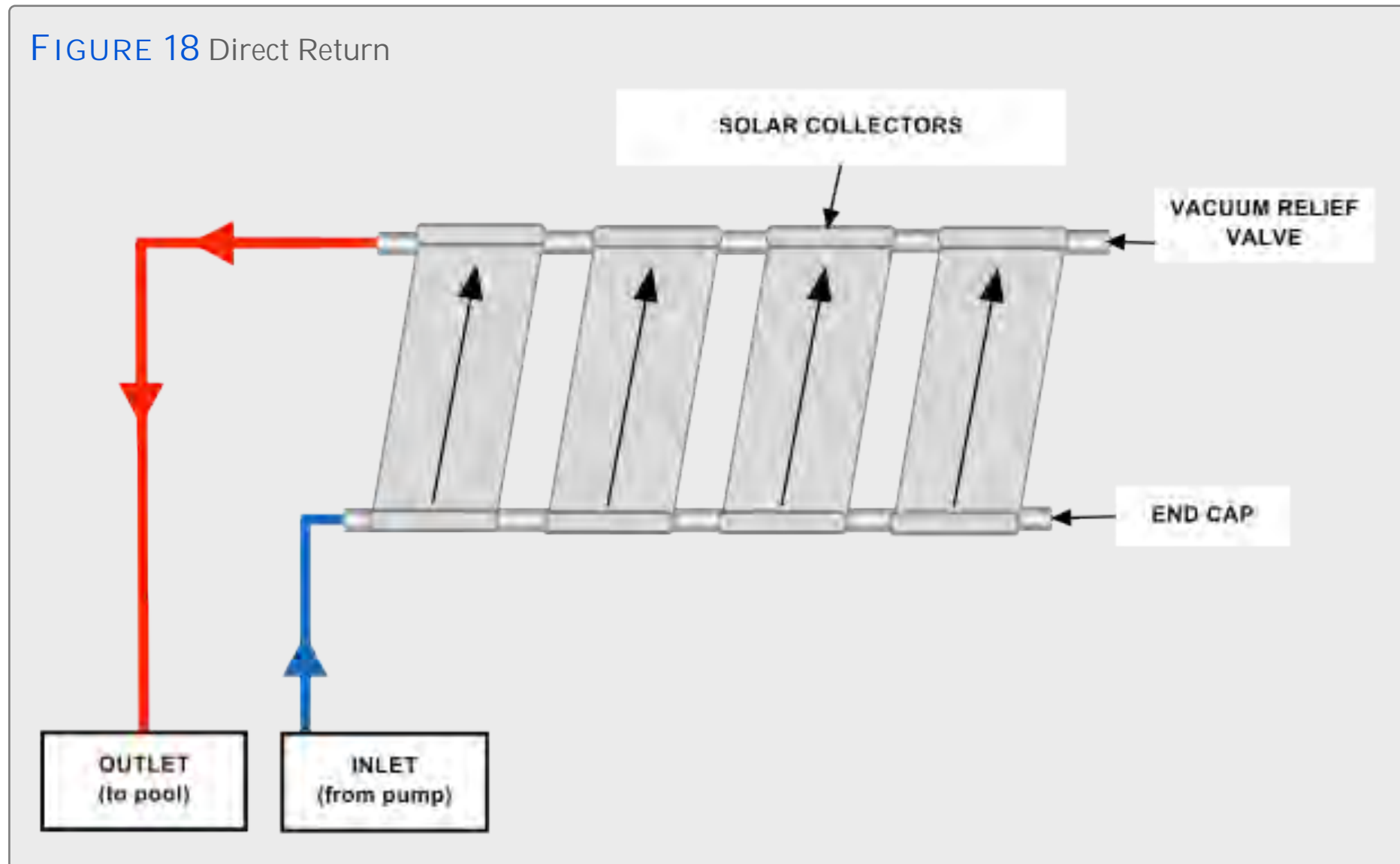
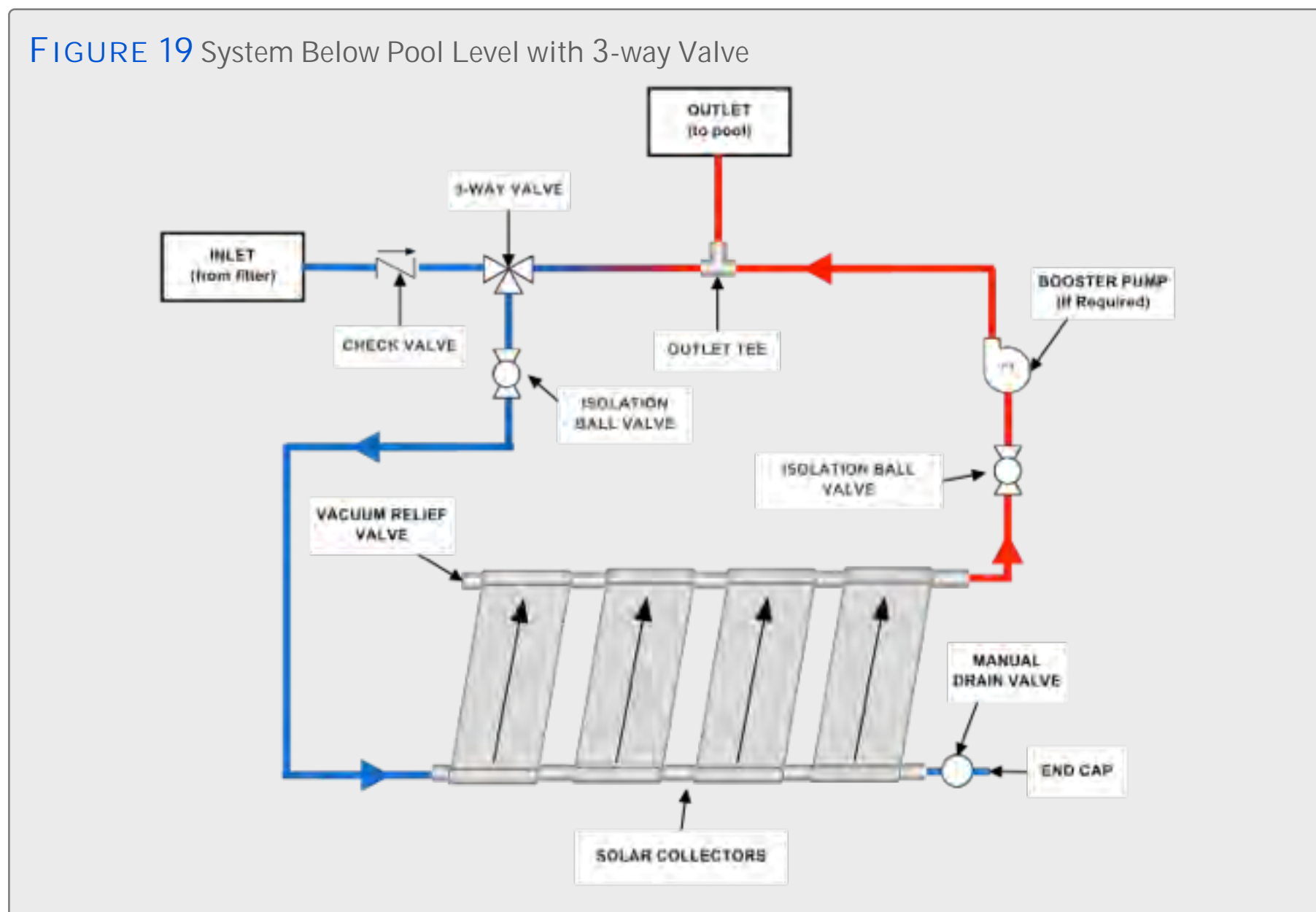

Figure 19: System Below Pool Level with 3-way Valve



Return to: [System Below Pool Level](#); [Booster Pump System](#); [Appendix Contents](#).

Figure 19A: System Below Pool Level without 3-way Valve

FIGURE 19 A System Below Pool Level without 3-way Valve

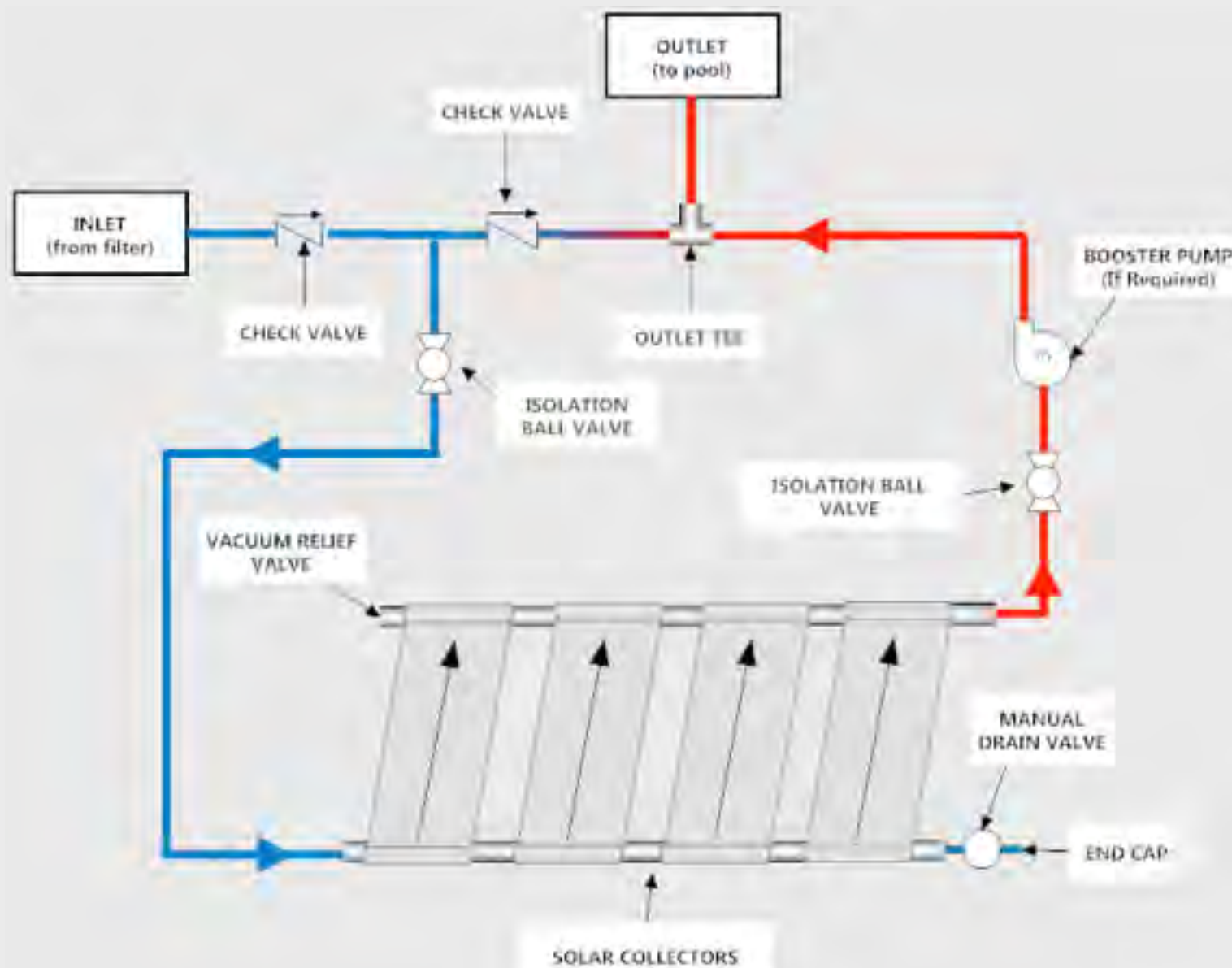

Return to: [System Below Pool Level; Booster Pump System; Appendix Contents.](#)

Figure 20: Collector Repair

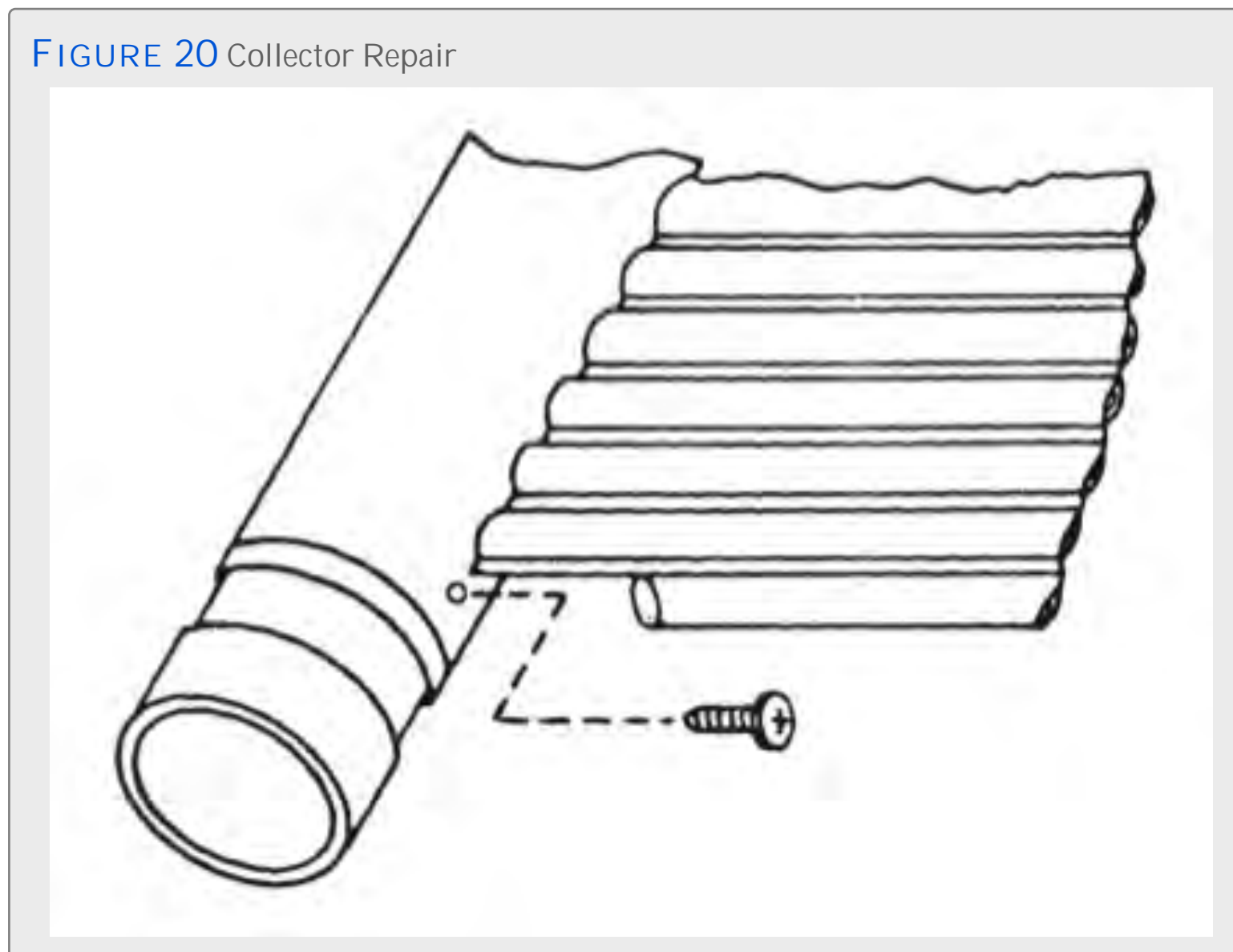

Return to: [Screw Method](#); [Appendix Contents](#).