

DELTA UV
For Swimming Pool and Spa
EA SERIES
In PVC OR IN STAINLESS STEEL



INSTALLATION AND MAINTENANCE MANUAL

DELTA ULTRAVIOLET CORPORATION
CORPORATE HEADQUARTERS

1535 W. Rosecrans Ave
Gardena, CA 90249
Phone 310-323-6400 – Toll free 866-UV9-8765
Fax 310-323-6403



Intertek

ETL FILE 3150259

EPA Est. #075659-CA-001

PN# 94.45406 - Rev. 4.2015

The sanitizer in the EA series has been designed to enable fast, easy installation. Its design also enables easy maintenance.

Please read these instructions carefully in order to ensure optimal operating conditions for your bactericide unit.



The Delta UV Unit is designed for use in swimming pools, fountains, water features, waterfalls and fish ponds. It is not designed for use in potable (drinking) water installations. Use of this product in applications other than those indicated above will void your warranty and could be harmful to your health or the health of others.

CONTENTS :

A. TECHNICAL CHARACTERISTICS.....

B. MAINTENANCE FILE.....

C. WARNINGS AND SAFETY

D. SANITIZER INSTALLATION

E. ELECTRICAL CHAMBER

F. START-UP.....

G. UV LAMP REPLACEMENT & QUARTZ TUBE MAINTENANCE

H. FAQ

I. TROUBLESHOOTING

DELTA UV LIMITED WARRANTY

A. TECHNICAL CHARACTERISTICS

EA Series				
	EA-9	EA-18	EA-26	EA-40
Material	Stainless steel / PVC			
Flow	3gpm	6gpm	9gpm	14gpm
Inlet / Outlet	2 in.	2 in.	2 in.	2 in.
Protection index	IP 54 NEMA 3	IP 54 NEMA 3	IP 54 NEMA 3	IP 54 NEMA 3
Power supply	120V/240V 50-60Hz	120V/240V 50-60Hz	120V/240V 50-60Hz	120V/240V 50-60Hz

EA-3H Series					
In PVC or In Stainless Steel					
	EA-3H5	EA-3H-10	EA-3H-15	EA-3H-20	EA-3H-40
Material	Stainless steel / PVC				
Flow	11gpm	14gpm	18gpm	28gpm	32gpm
Inlet / Outlet	2 in.	2 in.	2 in.	2 in.	2 in.
Nominal Power	30W	45W	55W	80W	90W
Protection index	IP 54 NEMA 3	IP 54 NEMA 3	IP 54 NEMA 3	IP 54 NEMA 3	IP 54 NEMA 3
Power supply	120V/240V 50-60Hz	120V/240V 50-60Hz	120V/240V 50-60Hz	120V/240V 50-60Hz	120V/240V 50-60Hz

EA-4H Series					
In PVC or In Stainless Steel					
	EA-4H5	EA-4H-10	EA-4H-15	EA-4H-20	EA-4H-40
Material	Stainless steel / PVC				
Flow	16gpm	20gpm	33gpm	42gpm	47gpm
Inlet / Outlet	2 in.	2 in.	2 in.	2 in.	2 in.
Nominal Power	30W	45W	55W	80W	90W
Protection index	IP 54 NEMA 3	IP 54 NEMA 3	IP 54 NEMA 3	IP 54 NEMA 3	IP 54 NEMA 3
Power supply	120V/240V 50-60Hz	120V/240V 50-60Hz	120V/240V 5-60 Hz	120V/240V 50-60Hz	120V/240V 50-60Hz

C. WARNINGS AND SAFETY

IMPORTANT SAFETY INSTRUCTIONS

SAVE THESE INSTRUCTIONS

READ AND FOLLOW ALL INSTRUCTIONS

WARNING

FOR YOUR SAFETY – This product should be installed by a professional service technician or similar person, qualified in electrical equipment installation. Improper installation and/or operation could cause serious injury, property damage or death. Improper installation and/or operation will void the limited warranty.

INSTRUCTIONS PERTAINING TO RISK OF FIRE, ELECTRIC SHOCK OR INJURY TO PERSON

WARNING — To guard against injury when using this unit, basic safety precautions should always be taken, including the following:

1. **READ AND FOLLOW ALL SAFETY INSTRUCTIONS.**
2. **DANGER:** To avoid possible electrical shock, special care should be taken since water is employed in the use of this equipment. For each of the following situations, do not attempt repairs yourself ; return the appliance to an authorized service facility for service or discard the appliance.
 - A. If the appliance falls into the water, **DO NOT** reach for it ! First unplug it and then retrieve it. If electrical components of the appliance get wet, unplug the appliance immediately.
 - B. Do not operate any appliance if it has a damaged cord or plug, or if it is malfunctioning or if it is dropped or damaged in any manner.
3. Do not use an appliance for anything other than its intended use. The use of attachments not recommended or sold by the appliance manufacturer may cause an unsafe condition.
4. Always unplug an appliance from an outlet when not it use, before putting on or taking off parts, and before cleaning. Never yank the cord to pull the plug from the outlet. Grasp the plug and pull it to disconnect it.
5. Never drop or insert any object into any opening.
6. This unit contains an ultraviolet bulb that can cause discomfort or irritation to the eyes if viewing while operating. Prolonged exposure to the eyes can cause blindness. **DO NOT VIEW UV BULB WHILE OPERATING OR DURING MAINTENANCE.**
7. Read and observe all of the important notices on the appliance.
8. Warning–To reduce the risk of electrocution, keep all connections dry and off the ground. Do not touch the plug with wet hands.
9. If an extension cord is necessary, a cord with a proper rating should be used. A cord rated for less amperes or watts than the appliances rating may overheat. Care should be taken to arrange the cord so that it will not be tripped over or pulled.
10. This product shall only be connected to a power supply receptacle protected by a Ground Fault Circuit Interrupter (GFCI). If this unit is not equipped (optional) with a GFCI, a GFCI should be provided by the installer and should be tested on a routine basis. To test the GFCI, push the test button. The GFCI should interrupt power. Push the reset button. Power should be restored. If the GFCI fails to operate in this manner, the GFCI is defective. If the GFCI interrupts power to the unit without the test button being pushed, a ground current is flowing, indicating the possibility of an electric shock. Do not use this unit. Disconnect the unit and have the problem corrected by a qualified service representative before using.
11. Always check Local Ordinance and Building Codes for your city before installation of equipment.
12. Protect the unit from direct prolonged sunlight exposure.
13. **ENVIRONMENTAL NOTICE - Hg-Lamp CONTAINS MERCURY. Manage in accord with disposal laws. See: www.lamprecycle.org**

INTRODUCTION

Forward: The Delta UV EA UV Unit is designed for use in spas, swimming pools, fountains, water features, and waterfalls. It is not designed for use in potable (drinking) water installations. Use of this product in applications other than those indicated above will void your warranty and could be harmful to your health or the health of others.

Introduction - How The DELTA UV Unit Works: Within the DELTA UV Unit (which we will refer to throughout this manual as EA), a high intensity electrically operated Ultraviolet (UV) bulb is located inside the unit's wet chamber. This UV bulb gives off Ultraviolet light wave emissions when lit. The bulb's operating emission range is within the Ultraviolet light wave spectrum at 253.7 nm of wavelength. This wavelength is such that when bacteria, protozoa, viruses, algae spores, or other single celled waterborne microorganisms in the incoming water flow are exposed to the light waves of the UV bulb for a proper period of time, the DNA of the microorganism is altered or disrupted and this controls and eradicates these unwanted contaminants and renders them harmless. Your EA UV unit has been sized to produce these important UV rays in the same intensity as is required for Class A potable drinking water, which are 30 microwatts/sec/cm².

While you may see lesser competitive units of similar vessel size claiming to work on larger spas or pools, you will find that these units do not operate at the same high intensity as does the EA unit and are unable to obtain the same level of killing power as the EA unit. Rely on the flow chart shown herein for proper maximum killing power unit selection for your application.

Spa or pool water containing these unwanted contaminants enters the EA unit's wet chamber and is exposed to the light rays generated by the UV bulb. The EA unit has been designed to allow for some turbidity in the water, as turbidity will reduce the UV light wave transmission capability. Therefore, all EA units are sized to allow for possible turbidity in the water and the reduction in the killing power of the UV bulb when it nears the end of its useful life. When the incoming water is exposed to the bulb for the proper duration and intensity, the water exiting the unit is near drinking water biological quality. **CAUTION! THIS UNIT IS FOR SPA, WATER FEATURE, FOUNTAIN OR POOL USE ONLY. DO NOT USE THIS UNIT FOR POTABLE (DRINKING) WATER SANITIZATION.**

Pre-Installation - In order to ensure that your EA unit functions with the proper exposure time to achieve the desired water sanitization, it is important to provide the proper water flow rate through the EA unit. If water passes through the unit too quickly, the exposure time of the microorganisms to the UV bulb produced rays will not be sufficient to obtain the desired kill rate. The water flow rate through the UV unit is governed by the piping of your vessel, pool or pond and the size and output of your circulation pump. There also needs to be consideration to the application for the UV unit. Fish ponds have different requirements than do swimming pools, spas, water features, fountains, or waterfalls.

Swimming Pool Turnover Rates - Swimming pools are somewhat simpler to calculate for flow rates. Most residential pools are designed to have the capacity of the pool turned over every 12 hours. Semi-commercial pools are normally designed for an 8 hour turnover flow rate. Check with your local jurisdiction for the required flow rate for your type of pool to be sure. As an example, using the same formula as above, a 20,000 gallon residential pool will need to have a pump capable of a 28 GPM flow rate and a 25,000 gallon semi-commercial pool will need to have a pump capable of 52 GPM.

Like pools and ponds, the EA unit needs to be properly sized by flow rate. Moving the water through the EA unit's wet chamber too fast will not allow enough exposure time of the water to be exposed to the UV bulb rays. The following charts show the desired and maximum flow rates for your EA unit. Make sure the flow rate of your circulation system pump does not exceed the maximum allowable flow rate of the UV unit you have selected. (Consult your supplier or pump manufacturer for the pump's GPM rating if you are in doubt.) If the pump output exceeds the

maximum flow rate of the EA unit you have selected, select an EA model with a higher flow rate capacity rating or consider a multiple unit installation. If your application exceeds the maximum flow rates for the EA-4H-40, multiple units can be used, or you can install a larger capacity Delta E/ES or EP series unit. In most instances a larger capacity unit is more cost effective than multiple units. Contact your supplier or Delta UV for information on these larger capacity UV sanitizers. (See Sec. 17.7).

Spa Turnover Rates - Spas also require proper flow through the UV system. Flow rates of the spa circulation pump should not exceed the maximum flow rate for the UV system selected. Excessive flow rates through the UV system will render the system ineffective. This holds for all applications. Never exceed the flow rate through the UV system as noted on brochures and data sheets.

3.0 Desired UV Unit Flow Rates – Spas, Swimming Pools, Fountains, Water Features





Delta UV EA Model	Maximum Flow Rate (GPM)	Maximum Flow Rate (m3/h)
EA-9	3	0.72
EA-18	6	1.4
EA-26	9	2.1
EA-40	14	3.2

Delta UV EA-3H Model	Maximum Flow Rate (GPM)	Maximum Flow Rate (mJ/cm2)
EA-3H-5	11	2.4
EA-3H-10	14	3.2
EA-3H-15	18	4.1
EA-3H-20	28	6.4
EA-3H-40	32	7.2



Delta UV EA-4H Model	Maximum Flow Rate (GPM)	Maximum Flow Rate (mJ/cm2)
EA-4H-5	16	3.6
EA-4H-10	20	4.6
EA-4H15	33	7.5
EA-4H-20	42	9.6
EA-4H-40	47	10.8

Note: Multiple units can be used for flow rates beyond those specified herein.

USE and MAINTENANCE:

	<ul style="list-style-type: none"> ● Allow the ultraviolet lamp to cool for at least 10 minutes before handling.
	<ul style="list-style-type: none"> ● Never look at the ultraviolet lamps when lit. This may cause severe injuries or burns and may even lead to loss of eyesight.
	<ul style="list-style-type: none"> ● Do not touch the ultraviolet lamp with bare hands, as these would leave impurities that shorten the life of the lamp. If you do touch it: clean with alcohol or white vinegar.
	<ul style="list-style-type: none"> ● Never unscrew the quartz tube sealing nut when the sanitizer is on load as the quartz tube could be blown out of the sanitizer with force and injure you.
	<ul style="list-style-type: none"> ● To avoid electric short-circuits; do not place the electric wires or the sanitizer in the pool water or in any other maintenance or cleaning fluid. ● Do not restart the system until the electric unit, the covers exterior elements of the sanitizer are correctly put back in place. ● When replacing the lamp or carrying out annual cleaning of the quartz tube, make sure that the electrical elements are in place and correctly attached before switching on the sanitizer.
	<ul style="list-style-type: none"> ● Do not use the Delta UV sanitizer for any other use than that for which it was designed. ● UV-Lamp CONTAINS MERCURY. Manage in accord with disposal laws. www.lamprecycle.org

D. REACTOR INSTALLATION

	<ul style="list-style-type: none">● CAUTION: We recommend the presence of a by-pass.
	<ul style="list-style-type: none">● Before accessing the connection terminals, ensure that all supply circuits are disconnected.● The sanitizer installation as a whole must be protected with a properly sized and protected circuit breaker. (See A. Technical characteristics)● Check Local ordinances and building codes before installation of equipment. (See A. Technical characteristics)

Installation - Before starting the installation, PLEASE read this manual from cover to cover. A few moments spent initially becoming totally familiar with the EA unit and its installation requirements will save a great deal of time (and expense) later. If you have questions that are not answered after you have completed the reading of this manual, contact your supplier or Delta UV. We are ready to assist you at anytime and we want your installation to go smoothly and the equipment to work properly.

Locating the UV Unit - Once you have confirmed the size of your spa or pool and compared that information against the requirements of your EA UV unit by using the charts above, it is now time to install your unit. The EA unit comes with all internal components fully assembled and ready for installation. Only the Inlet/Outlet unions and (if used) stainless steel mounting legs need to be installed to ready your unit for installation. The housing of the EA UV unit is stainless steel and the black inlet and outlet ends are UV inhibited ABS plastic. Your unit will function fine in the outdoors. Installing the EA unit indoors or inside a covered area is preferred however, to keep your unit looking new. The EA unit will need to be powered from an electrical outlet. If the electrical outlet is outdoors and exposed to the weather, it will need to be an Outdoor type receptacle. The EA unit comes with a five foot (minimum) (1.5 meter) long power cord. Do not use an extension cord unless it is at least a 16/3 size conductor waterproof type and is no more than twenty-five feet (7.5 meters) long.

Plumbing the UV Unit - Your EA unit will need to be plumbed into your spa or swimming pool circulation system. The diagram (Fig. 1) shows how the unit is to be plumbed. Note that the water is to be piped from the pressure side of the pump and after the filter, in and out of the EA unit. When the EA unit is in a vertical position, the inlet for the water is at the bottom of the EA unit, and the outlet is at the top of the EA unit. The EA unit may also be mounted in a horizontal position and in that instance; water can enter and exit from either end of the unit. If your pump exceeds the maximum flow rate of the EA unit, installation of a plumbing by-pass will be necessary to bypass some of the pump's flow around the EA unit so the maximum flow rate of the EA unit will not be exceeded. Bypass system is also recommended in cold climate areas for winterizing of unit (See Sec.). A typical bypass arrangement is shown in Fig. 1. (NOTE: A bypass system will allow only the water that passes through the EA unit to be sanitized. Therefore, a by-pass should be used only to bypass a very small amount of water and the main flow should be through the EA unit itself for maximum killing power.)

Installing Inlet/Outlet Unions - The EA unit comes with union nuts installed on the housing. Packed with your EA unit are the remaining components necessary to complete the Inlet/Outlet unions. The clear union tail piece is used on the water outlet union, and the solid color union tail piece is used on the bottom inlet union. Also packed with your EA unit are two rubber-like gaskets that are used to complete the Inlet/Outlet unions. One side of the gasket is flat; the other side has a half round bead on the face. The two PVC unions each have a groove in the face of the union tail piece and that groove accepts the half-round bead of the gasket to hold the gasket in place correctly. Place the gaskets into the face of the union tail pieces. Now, install the union tail pieces by screwing them into the union nuts on the EA unit. DO NOT OVERTIGHTEN. Hand tightening is sufficient. OVERTIGHTENING WILL BREAK THE UNION NUTS.

Installing The Mounting Legs - Your EA unit comes with two stainless steel mounting legs and two stainless steel band clamps. The legs can be used to mount the EA unit to a solid surface, such as a wall or the floor. FAILURE TO PROPERLY SECURE THE UNIT MAY CAUSE NOISE DUE TO VIBRATION CAUSED BY WATER PASSING THROUGH THE WET CHAMBER. As the EA unit is not heavy, it can also be mounted directly to the rigid PVC plumbing of your pool, spa or pool. If the mounting legs are used, it is recommended that the band clamps be placed over each plastic end of the EA unit, rather than over the stainless steel housing, to facilitate removal of the stainless steel housing without requiring removal of

the unit's plastic ends. The stainless steel housing has two unions to allow the inlet and outlet to be rotated for plumbing convenience. Each end of the EA unit can be rotated 360 degrees to accommodate the piping from any angle of approach.



Inlet / Outlet Unions

Your Delta UV unit will need to be plumbed into your spa, pond or swimming pool circulation system.



Reminder: We recommend the presence of a by-pass.

The inlet for the water is at the bottom of the Delta UV unit.

The SOLID COLOR union tail piece is used on the BOTTOM union.

The outlet for the water is at the top.

The CLEAR union tail piece is used on the TOP union.

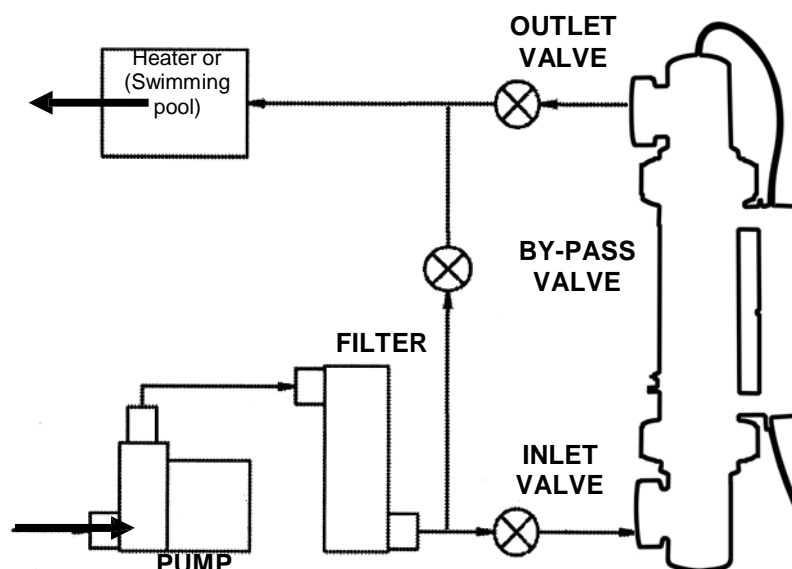



Fig. 1

Gluing Piping To The UV Unit-The Inlet/Outlet PVC union tail pieces are 2 inch pipe size. Your PVC supply piping should be glued into the union tail pieces using an appropriate PVC primer and PVC cement, as recommended by your supplier. Inlet piping should be supported and should not rest solely upon the unions, to avoid breaking the unions. The installation of valves on the inlet and outlet lines attached to the UV unit is recommended for future servicing. If the EA unit is located with any portion of the unit below the surface of the pond or pool, then VALVES ARE MANDATORY, so you may winterize or remove the EA unit without draining your spa or pool. When you have completed the piping installation (including bypass if necessary), the final step is to plug the unit into its power source.

Also packed with your Delta unit are two white gaskets that are used to complete the Inlet/Outlet unions.

- 1) **Install the union tail pieces by screwing them into the union nuts on the Delta unit.**
- 2) **DO NOT OVERTIGHTEN (hand tightening is sufficient). Over tightening will break the union nuts.**

ELECTRICAL BONDING (GROUNDING)

	<p>DANGER - RISK OF ELECTRICAL SHOCK – RISK OF INJURY OR DEATH IF ELECTRICAL INSTALLATION AND BONDING ARE NOT DONE PROPERLY. If you are in doubt, have this important work done by a Licensed Electrician!</p>
---	---

	<p>DANGER: RISK OF ELECTRIC SHOCK. Connect only to a circuit protected by a Ground Fault Circuit Interrupter.</p>
---	--

Electrical Connection - The electrical power rating for your EA unit is shown on the label on the outside of the unit. US and Canadian EA units operate on 120V/50/60Hz – (.750 Amps maximum). This extremely low power consumption makes operating your EA unit very economical. Therefore, you will need a 15 Amp 120V receptacle for your EA unit to plug into. (Check the label on your overseas unit for its power requirement.) Your EA unit is supplied with a five foot (1.5 meter) long weatherproof power cord terminating in either a 3-prong grounded NEMA plug. The plug assembly contains the electrical ballast that operates the UV bulb in the EA unit. Ballast should be mounted to secured object with 3-prong grounded NEMA plug end facing downward. In the US or Canada it is mandatory that you install a GFCI in the electrical outlet or in the breaker panel serving the EA unit power receptacle. NOTE: Should the electrical power cord of your EA unit become frayed or damaged in the future, unplug it from the power receptacle and replace it immediately.

Your EA unit can be exposed to the weather; however you must protect the electrical plug by providing an Outdoor type electrical receptacle to prevent rain and such from entering the plug connection. Overseas 240 volt EA units are supplied with a separate mounting box that is hard wired into the electrical system.

Electrical Bonding (Grounding) - As required in the US by Article 680, NEC and many local electrical codes, all metallic equipment of your pond, spa or swimming pool system must be electrically bonded to a common bonding grid, using a continuous #8 bare copper wire to connect

all components (pump, filter, EA unit) together using the ground lugs supplied with each component. The EA unit has a pressure grounding lug located on the stainless steel housing to accommodate this function. Connect the bonding wire from the bonding grid to the grounding lug supplied on the EA unit.

Electrical Interlock of Pump/EA Unit - The EA UV unit will turn ON whenever there is power supplied to the electrical receptacle servicing the unit. However, your EA unit should only be energized when there is water flowing through the unit. Therefore, it is important that you do not plug your unit into the electrical receptacle until you have the pump operating and water is flowing through the EA unit. This is to ensure that the bulb will not create excessive heat when the EA unit is empty or water is not flowing in the wet chamber. Such excessive heat can shorten the life of the UV bulb. If your pump is turned OFF and ON by a time clock, the electrical receptacle servicing the EA unit should be electrically interlocked with the pump, so that the EA unit is turned OFF at the same time the pump is turned OFF. When the EA unit is properly powered or interlocked and whenever the pump is pumping water through the EA unit, you will be able to confirm lighting of the bulb. To confirm that the bulb is indeed lit, you can view the glow of the bulb through the clear plastic union tail piece at the top outlet of the EA unit. This is the only location where you should attempt to view the UV bulb while it is on. The PVC union tail piece screens out the harmful UV rays and can be viewed with the naked eye without any damage to the eyes. If the bulb is not lit after you power the EA unit, check the troubleshooting section at the end of this manual. The electrical supply installation is now complete.

E. ELECTRICAL CHAMBER

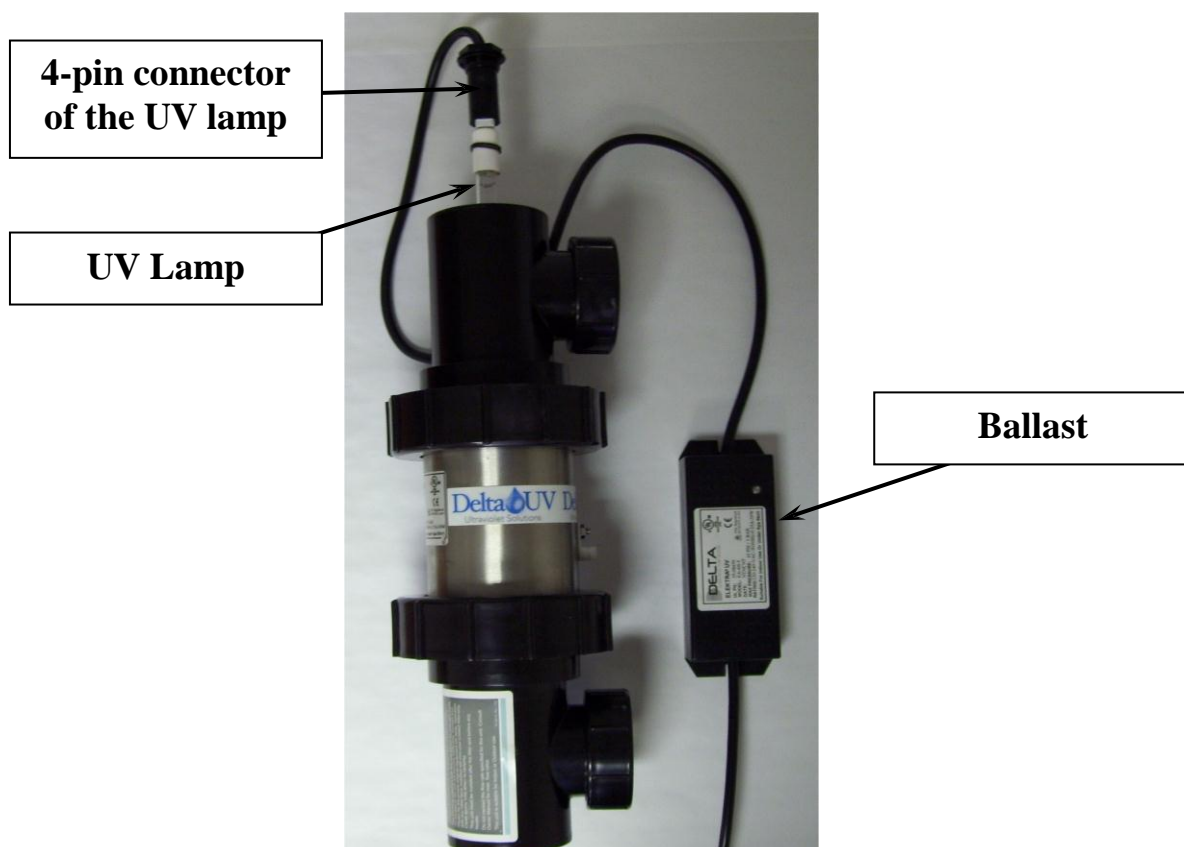

F. START-UP

1	Start the circulation pump.
2	Drain all air from your system through the air relief valve on the filter (if so equipped).
3	Check EA Unit For Leaks - Make one final check for leaks in your piping, accessories, and the EA unit unions. If any water leakage appears at the EA unit's power cord exit point, disconnect the EA unit immediately. This is a sign of the glass quartz tube inside the EA unit being broken or cracked during transit or during installation. The glass quartz tube can be visually inspected by removing the stainless steel housing from the plastic electrical end of the EA unit by loosening the plastic end from the stainless steel housing using the union nut present on the housing. If the glass quartz tube is cracked or broken, contact your supplier or Delta UV for a replacement. Do not operate the EA unit until this problem is corrected.
4	<p>Check the chemical balance of your spa or pool (particularly pH, TAC* and TH*). Adjust the chemical balance as per your spa and pool chemical supplier's instructions. - Remember, the EA unit dramatically <u>reduces</u> the need for spa and pool chemicals, but does not eliminate the need for proper spa or pool chemical balance.</p>  <p>Reminder: Your Delta UV does not eliminate the need for proper pool chemical balance.</p>

* TAC = Alcalimetric Titration (alkalinity of water)

* TH = Water Hardness

G. UV LAMP REPLACEMENT & QUARTZ TUBE MAINTENANCE

The High Output UV bulb in your Delta UV unit is a useful life of approximately 13,000 hours of operation (except in the case of repeated lightings where its lifespan could be lower).

The replacement of lamp after 13,000 hours is mandatory.





The quartz tube should be removed, inspected and cleaned from the sanitizer every year and at each replacement of lamp.



Reminder: Do not touch the UV bulb glass with your bare hands.

That can shorten its life. Grasp the bulb on the white ceramic prong end or use a soft clean cotton cloth or clean cotton gloves to handle the UV bulb. (If you have touched the bulb with your bare hands, you must wipe the bulb glass off with spirit vinegar using a clean soft cotton cloth)

1		<p>STOP THE FILTRATION. (Disconnect Power- Unplug the EA unit from its power receptacle) BLEED the EA unit.</p>
2	Allow the ultraviolet lamp to cool for at least 10 minutes before handling.	

3		<p>Remove the Delta UV unit from the water circulation system. CAUTION! NEVER REMOVE ANY EA UNIT COMPONENT WITHOUT FIRST UNPLUGGING THE EA UNIT FROM ITS POWER SOURCE AND REMOVING ALL PRESSURE FROM INSIDE THE EA UNIT'S WET CHAMBER.</p>
4		<p>Unscrew the top black plastic housing union attached to the tee fitting.</p>
5		<p>Unscrew the 4-pin connector from the lamp (attached to the ballast wires). In order to replace the UV bulb, it is necessary to unscrew the electrical connector assembly from the electrical tee assembly. The electrical connector is removed from the plastic electrical tee at the top of the EA unit by unscrewing (rotating counter-clockwise) the connector from the upper (electrical end) plastic body. Note that there is an O-Ring between the electrical connector and the plastic body. Locate the O-Ring and put it aside for re-installation later.</p>
6		<p>Remove the UV Bulb. When you unscrew the electrical connector, remove it slowly from the electrical body. While you are removing the electrical connector from the body, you will be removing the UV bulb at the same time. Pulling up on the electrical connector too quickly may cause the four pins of the UV bulb to become separated from the electrical connector, causing the bulb not to be removed at the same time as the electrical connector. If this occurs, bulb removal can be accomplished after the electrical connector is removed by simply placing the EA unit upside down and the bulb will drop out of the EA unit into your hand. Do not allow the bulb to fall onto the floor as it will most likely break.</p> <p>Unplug the UV Bulb from the electrical connector by grasping the bulb by the white porcelain connector near the top of the bulb and at the same time, pull the electrical connector from the bulb. DO NOT TOUCH THE UV BULB GLASS WITH YOUR BARE HANDS! Use a soft clean cotton cloth or clean cotton gloves to handle the UV bulb. Skin oils on your hands can remain on the bulb and cause hot spots on the bulb which can shorten the bulb life.</p>
7		<p>Carefully place the removed bulb in a safe location while cleaning the quartz tube.</p> <p>Remove the Bulb Cushion and O-Rings - In order to properly position the UV bulb inside the quartz tube, a bulb cushion (Part #44-02019) and two O-Rings (Part #44-02221) are place on the UV bulb. Locate them and set them aside if you plan to use them in the future. They may be found inside the quartz tube (if they become dislodged from the UV bulb during removal from the quartz tube) or on the UV bulb itself.</p>
8		<p>Remove Plastic Plumbing/Electrical Tee Fitting-The plastic plumbing/electrical tee is removed by unscrewing the plumbing union and housing unions attached to the tee fitting. Once all unions are unscrewed, slowly lift the tee fitting (with quartz tube attached) from the stainless steel EA unit body. You now have the quartz tube assembly removed from the EA unit and ready from cleaning.</p> <p>The quartz tube exterior can normally be cleaned by mixing a mild solution of Muriatic Acid (available at all pool supply stores) with water in a ratio of four parts water to one part acid. CAUTION: Follow the directions for use and handling of Muriatic Acid on the acid bottle label, being careful to protect your eyes, wear rubber gloves and avoid breathing fumes. DO NOT USE ABRASIVE CLEANERS as they can scratch the high quality quartz glass. If lime or hard water calcium deposits are encountered, lime removal products that are available in grocery stores can be used. These products will not harm the hard glass surface of the quartz tube. Complete the cleaning of the quartz tube, rinse it off and</p>

9	<p>Carefully inspect the cleaned quartz tube for cracks. If any cracks in the quartz tube are found, the quartz tube assembly must be replaced. Broken quartz tubes will allow water to enter the dry electrical chamber, cause the GFCI to trip and attack the electrical components of the unit, which will cause them to fail and need to be replaced. <u>BROKEN QUARTZ TUBES, OR WATER DAMAGE CAUSED BY BROKEN QUARTZ TUBES, ARE NOT COVERED UNDER YOUR LIMITED WARRANTY.</u></p> <p>Note : The quartz tube is attached to the tee fitting, it does not unscrew!!</p>
	<p>Re-installing Quartz Tube - The process of reinstalling the quartz tube is just the reverse of the removal process.</p>
10	<p>Bulb Cushion Installation - Seat the bulb end cushion on the end of the bulb (the end that goes down into the quartz tube first).</p> <p>O-Rings Installation - Place the two O-Rings around the top white porcelain bulb end cap (where the electrical pins are located).</p> <p>Connecting the Bulb Pins to the Bulb Connector - By grasping the UV bulb by the white porcelain pin end, insert the four silver pins on the bulb into the white bulb pin connector extending beyond the end of the electrical assembly. Note that the four pins are not symmetrical from one another. Two pins are close together and two are further apart. Make sure when you are installing the pins into the pin connector, which the pins align correctly with the pin connector assembly. Push the bulb firmly into the pin connector, but do not force the pins into the pin connector. If force appears to be required, it is an indication that the pins are not aligned with the pin receptacle. The bulb must be attached to the electrical assembly before inserting the bulb into the quartz tube.</p> <p>Inserting the Bulb Into the Quartz Tube -The last step before inserting the bulb into the quartz tube, is to make sure the O-Ring that goes between the electrical connection assembly and the electrical tee fitting is in place and once confirmed, make sure the bulb cushion is in the downward end of the bulb and that the bulb's O-Rings have not become dislodged from the white ceramic on the end of the bulb while the bulb is being inserted down into the quartz tube. Re-position the bulb O-Rings if necessary. Slowly lower the bulb into the quartz tube.</p>
11	<div data-bbox="316 1160 528 1496" data-label="Image"> </div> <p>Screw the 4-pin connector and once the electrical assembly has been threaded onto the electrical tee, rotate the electrical assembly clockwise SLOWLY until the electrical assembly is screwed completely onto the electrical tee and is flush with the top of the electrical tee. You may use a wrench to secure the two pieces however, only a slight tightening should be done. DO NOT OVERTIGHTEN. There is no water behind the electrical assembly therefore; the connection need only be tight enough to allow the sealing O-Ring to prevent water from entering the electrical connection during inclement weather.</p>
12	<p>Put the Delta unit on the water circulation system by screwing the inlet and outlet unions.</p> <p>Turning On The Circulation Pump Back On - Before power is restored to the EA unit; water must be flowing in the EA unit's wet chamber. Verify that all valves are open in the plumbing lines servicing the EA unit and that you have a good water flow through the EA unit and back to the pool, spa or pond, before applying electrical power to the EA unit.</p>
13	<p>Plugging The EA Unit Power Into the Power Receptacle - Plug the EA unit back into the electrical receptacle servicing the unit. Verify that the bulb is lit by viewing the glow of the bulb through the clear plastic union fitting at the outlet of your EA unit. Once you have verified that the bulb is lit while the pump is operating, your EA unit is ready for service.</p>

WINTERIZING

Your DELTA UV unit can be damaged if allowed to freeze. The substantial pressure inside the wet chamber caused by ice forming inside the wet chamber can break the glass quartz tube as

well as the wet chamber itself. Therefore, you must protect your DELTA UV unit from freezing. Damage due to freezing, including breakage of glass components, the wet chamber, or water damage to other components caused by freezing **IS NOT COVERED** under your Limited Warranty.

Freeze damage - Freeze damage can be avoided by keeping the water flowing at a minimum of 5 PSI pressure (as noted on the operating pressure gauge) at all times, without interruption during freezing temperatures. All time clocks must be inoperable and the pump must run continuously. Freeze damage can also be avoided if the pump and DELTA UV unit are maintained inside a warm enclosure.

Freezing Weather Precautions - If you do not plan to operate your DELTA UV unit during freezing temperatures, you must take precautions to make sure all water is removed from inside the DELTA UV wet chamber so it does not freeze inside the wet chamber and damage the DELTA UV unit. This can be accomplished by first closing any valves on lines in the plumbing system and then open the inlet union at the bottom of the DELTA UV unit so that the water is drained from inside the wet chamber tank. Place the DELTA UV unit in a warm location during freezing temperatures, after draining all the water from the unit and removing it from the plumbing. Caution: A drain valve and piping to carry water away from the DELTA UV unit must be installed if drainage of the DELTA UV unit will cause water damage to the area surrounding the DELTA UV installation.

PART NUMBER MATRIX								
MODEL	ITEM#1-120/240V	ITEM #3	ITEM #3 PVC	ITEM #4	ITEM #6	ITEM #10	ITEM #13	ITEM #15
EA-9	70-10146	78-07342	86-07342	86-02370	44-02340	86-02039	58-50210	70-18309
EA-18	70-10146	78-07344	86-07344	86-02370	44-02340	86-02039	58-50217	70-18316
EA-26	70-10158	78-07346	N/A	86-02370	44-02340	86-02039	58-50227	70-18326
EA-40	70-10198	78-07348	N/A	86-02370	44-02340	86-02039	58-50241	70-18340
EA-3H-5	70-10196	78-07352	86-07352	86-02370	44-02340	86-02039	58-50306	70-18405
EA-3H-10	70-10196	78-07354	86-07354	86-02370	44-02340	86-02039	58-50311	70-18410
EA-3H-15	70-10198	78-07355	86-07355	86-02370	44-02340	86-02039	58-50316	70-18510
EA-3H-20	70-10198	78-07356	86-07356	86-02370	44-02340	86-02039	58-50321	70-18420-S
EA-3H-40	70-10198	78-07358	86-07358	86-02370	44-02340	86-02039	58-50341	70-18440-S
EA-4H-5	70-10196	78-07452	86-07452	86-02364	44-02246	86-02037	58-50406	70-18405
EA-4H-10	70-10196	78-07454	86-07454	86-02364	44-02246	86-02037	58-50411	70-18410
EA-4H-15	70-10198	78-07455	86-07455	86-02364	44-02246	86-02037	58-50416	70-18510
EA-4H-20	70-10198	78-07456	86-07456	86-02364	44-02246	86-02037	58-50421	70-18420-S
EA-4H-40	70-10198	78-07458	86-07458	86-02364	44-02246	86-02037	58-50441	70-18440-S

NOTES:

- 1- OPTIONAL SIZE TAIL PIECES ARE AVAILABLE**
- 2- EA - 120V MODELS ONLY**
- 3- OPTIONAL PLUG CONFIGURATIONS ARE AVAILABLE**

CONTACT YOUR SUPPLIER OR DELTA UV FOR INFORMATION

TAIL PIECE MATRIX – SEE NOTES		
SIZE	ITEM#2	ITEM#9
2" SKT	86-02352C	86-02352

ITEM	DESCRIPTION	QTY	PART #
1	ELECTRONIC BALLAST ASSEMBLY	1	SEE MATRIX
2	UNION TAIL PIECE - CLEAR	1	SEE MATRIX
3	UV BODY – STAINLESS STEEL/PVC	1	SEE MATRIX
4	UNION NUT	2	SEE MATRIX
5	RETAINER NUT – EA & EH – 3H ONLY	2	86-02360
6	O-RING OR GASKET	2	SEE MATRIX
7	BULB CUSHION	1	44-02019
8	FLAT O-RING GASKET – 2"	2	44-02335
9	UNION TAIL PIECE – WHITE	1	SEE MATRIX
11	STAND – STAINLESS STEEL	2	82-02019
12	CLAMP – 3" STAINLESS STEEL	2	40-08004
13	TEE ASSY WITH QUARTZ TUBE	1	SEE MATRIX
14	O-RING – 024 – BLACK	1	44-02216
15	UV BULB	1	SEE MATRIX
16	BULB O-RING	2	44-02221

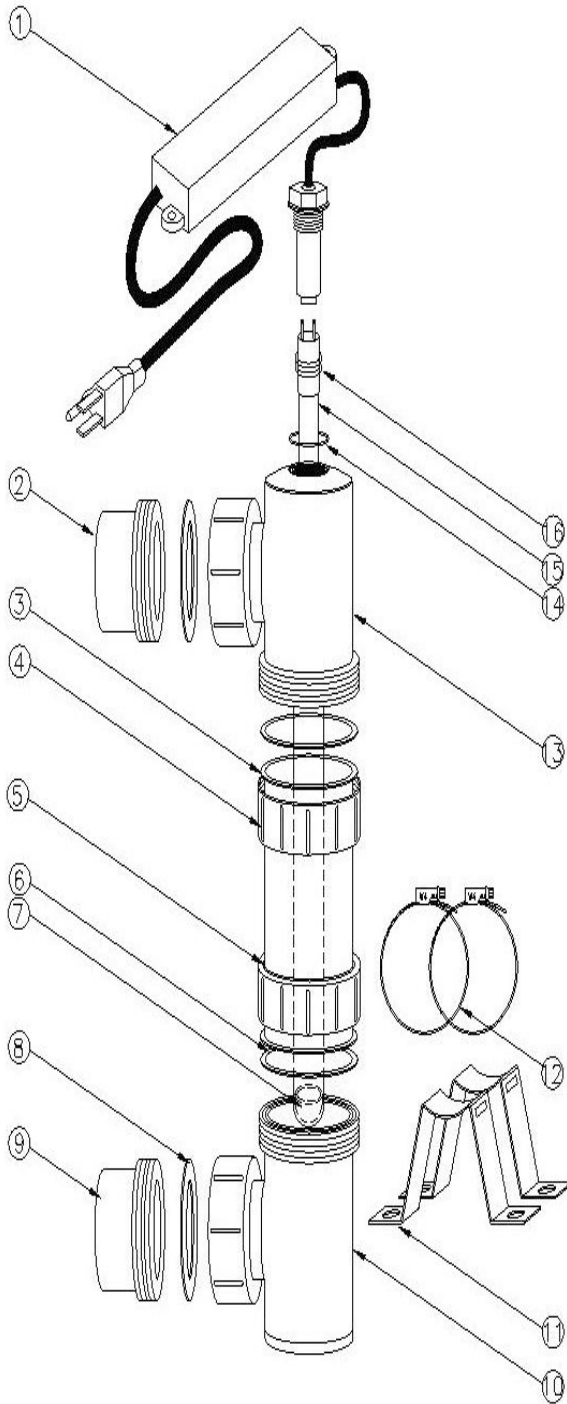

H. FAQ

Here are a number of FAQ's that will answer some of the most common questions.

Is the Delta UV System Designed For Salt Water Use?

While the ability of the system is not affected by salt water, the harsh environment found in salt water ponds and aquariums is not recommended for the EA UV units due to the stainless steel construction. Contact your supplier or Delta UV if you have a salt water system and they will supply you with information on the Delta UV system which is totally compatible with salt water environments. Salt chlorine generators however are compatible with all Delta UV systems, as they operate in a minimum salt level environment. Sea water is not compatible.

Do I Need To Turn My EA Unit Off When I Clean My Filter?

Yes. Anytime the water flow is interrupted to the EA unit, the power to the unit should be turned off at a switch or breaker controlling the receptacle that supplies power to the EA unit, **BEFORE** the water flow is interrupted. If no switch or breaker is convenient, you can accomplish this by simply unplugging the EA unit from its power outlet.

Will A Time Clock On My Pool Shorten My Bulb Life?

Some shortening of the bulb life can be expected when the EA unit is turned off and back on frequently. A daily on/off cycle will not create a major bulb life issue however; frequent on/off cycles should be avoided.

Is There Any Residual Effect From UV?

No, UV light is used as a control and is applied only to the water that passes inside the EA wet chamber in visual contact with the UV transmission from the UV bulb. No chemical change to your pool, spa or pond water takes place.

Can the EA Unit be Mounted Horizontally?

Yes, the EA unit can be installed in any position. When mounting the unit, make sure that the water outlet is placed higher than the inlet, so the unit will not drain and allow the quartz tube to operate dry. This will ensure that the quartz tube remains submerged at all times. When mounting the unit horizontally, either union can be used for inlet or outlet.

Can the EA Unit be Installed Below the Pond, Spa or Pool Waterline?

The EA unit can be installed below the waterline. Consideration should be given for future winterizing and servicing of the EA unit. The uses of valves on both sides of the UV unit are a must to isolate the EA from the pool or pond water. **NOTE: DO NOT INSTALL ANY EA SERIES UNIT BY IMMERSING IT IN THE VESSEL WATER.** All EA Series units are suitable for outdoor installation, but are not suitable for immersion in the water. **SERIOUS DAMAGE WILL OCCUR TO THE EA UNIT IF SUBMERSED, AS WELL AS RISK OF ELECTRICAL SHOCK.** Submersion of the unit will void your Limited Warranty.

Can Multiple Units Be Used Together For Larger Systems?

Yes, you can add any number of EA units to a plumbing bypass manifold system to allow for larger outputs and flow rates beyond the capacity of a single EA-4H-40 unit. Delta UV also manufactures the Delta E, Delta ES, Delta EP series of UV systems for larger capacity ponds and pools. If you need to utilize more than two EA systems to meet your larger pond or pool's requirements, you will find it more economical to select one of the other quality Delta UV systems that are available. Contact your supplier or Delta UV for complete information and pricing of these larger capacity UV units.

Must I Use a GFCI (Ground Fault Circuit Interrupter) with My UV Unit?

YES, this is a requirement in the US and Canada, and in some overseas countries. A 15 Amp 120V GFCI needs to be utilized to protect the EA unit and its users. Either a GFCI receptacle (similar to those used in bathrooms) or a GFCI breaker can be used to provide this important electrical protection.

I. TROUBLESHOOTING

The list below will help guide you through any problems you may have at time of initial installation or in the future. For additional assistance, contact your supplier or BIO-UV at the address, e-mail or phone shown at the end of this manual.

The UV Bulb Will Not Light - If this occurs upon initial start-up, the problem could be caused by a number of issues.

- a. **The bulb has become disconnected from the bulb connector** - Disconnect the power cord from the electrical outlet, open the electrical enclosure bonnet and confirm the bulb connector is firmly in place. At the same time, check all exposed wires for a possible loose connection. Plug the electrical cord back into the electrical outlet ONLY after the electrical enclosure bonnet has been re-installed on the EA unit, and the pump is ON.
- b. **Verify that the electrical cord is plugged into a hot outlet** - Test the electrical outlet. You should confirm the availability of the same power as indicted on the electrical label on your EA unit.
- c. **Make sure you have not plugged your unit into any power source other than that specified on your unit's electrical label** - If you have done so in error, the ballast has been damaged and needs to be replaced. Contact your supplier for the correct replacement ballast.

The UV Bulb Was Lit But Now Is No Longer Lit - This occurs after the unit has been operating successfully for a period of time.

- a. **The bulb has burned out.** - Replace the UV bulb. Contact your supplier or Delta UV to obtain a replacement bulb for your EA unit.
- b. **The ballast has burned out.** - Contact your supplier or Delta UV for assistance in obtaining a new power cord/ballast assembly.
- c. **There is no power to the outlet** - Verify that the electrical outlet where the EA unit is plugged into has the proper voltage and the EA unit's power cord is securely plugged into the outlet.
- d. **The GFCI has tripped** - Verify that the GFCI has not tripped. To verify the operating state of the GFCI, trip the GFCI manually and reset it manually. The GFCI should reset. If it does not, it indicates a fault to ground in the electrical circuit or the EA unit itself. See sec. below.

The UV Bulb Stays Lit When The Pump Is Off - The UV bulb should not be lit when there is no water running through the EA unit's wet chamber. This condition will cause the bulb to burn out very quickly due to the heat generated by the UV bulb inside the quartz tube when no water is flowing to carry off the heat.

- a. **Time clock interlock missing** - If a time clock is used, it should be electrically interlocked to the electrical outlet servicing the EA unit, so the power to the outlet is interrupted whenever the clock turns the pump OFF. If this condition is present, refrain from using the EA unit until an electrical interlock is installed.
- b. **EA unit not unplugged when pump is OFF** - If no electrical interlock to the pump is present, the electricity to the EA unit must be halted by unplugging the electrical power cord from the wall receptacle before turning OFF the pump. To eliminate this necessity, electrically interlock the EA unit poser receptacle to the pump.

The Water Is Green - Green water is an indication that the UV rays generated by the EA unit are not sufficiently powerful to be effective or are not being generated at all by the UV bulb (bulb at end-of-life).

- a. **Bulb not lit** - Check the bulb to make sure it is ON. If it is not ON, follow the procedures above regarding the UV bulb not lighting.
- b. **EA unit not operating long enough** - Run your unit longer. If your unit is operating on a time clock, run the circulation pump longer to allow the EA unit to function fully. It is especially important to allow the unit to run continuously at initial start-up.
- c. **Quartz tube dirty** - Clean the quartz tube.
- d. **Bulb at end of life (EOL)** - Replace the UV bulb if it is nearing the one (1) year useful life. At one year of operation, the UV bulb is 60% as effective as it was when it was new. This is normal for all low-pressure type UV bulbs, which are the longest life bulbs used in this type of application.

- e. **Pool Chemistry Is Off** - If your EA unit is installed on a swimming pool, shock the pool with the sanitizing chemical you normally use and balance the pool water as per your chemical manufacturers' specifications.
- f. **Pump Flow Exceeds Unit Design Capacity** - Your unit is undersized if the water is not clearing up on a new installation. Check the flow rate of the pump and compare it to the maximum flow rate for your unit (available online at www.deltauv.com). Flow rates in excess of the maximum flow rate of your UV unit will render the system ineffective as there is not sufficient exposure time of bacterium to the lamp rays. Replace with a properly sized system for your flow rate and the water will clear up.

The GFCI Has Tripped - The GFCI protects the system from any fault to ground, as the electrical breaker protects the electrical circuit. When it trips, it is an indication that there is an electrical problem that must be corrected to provide a safe operating environment in your pool or pond.

- a. **Test the GFCI** - Disconnect the EA unit from the electrical receptacle. Reset the GFCI at the breaker panel or at the receptacle. If the GFCI does not reset, replace the GFCI. If the GFCI does reset, plug the EA unit into the electrical receptacle and make sure the pump is on. If the GFCI trips, it is an indication that there is a ground fault inside the EA unit. Follow instructions previously given for replacing the bulb.
- b. **Inspect the EA unit's electrical assembly** - If water is present inside the electrical enclosure or quartz tube, it will trip the GFCI. Following instructions given previously remove the quartz tube, inspect it for cracks or breakage or for a bad quartz tube seal. Replace the quartz tube if it is cracked.
- c. **UV Bulb is causing GFCI tripping** - You can check the UV bulb for GFCI trip cause by unplugging the bulb from the bulb connector, then plugging the electrical plug back into the electrified electrical outlet (make sure the outlet is powered). Reset the GFCI and if it does not trip, it indicates that the UV bulb is causing the fault to ground. Replace the UV bulb. If the GFCI does not reset, then the problem is with the ballast or the electrical power cord. Replace the ballast/cord assembly.

The EA Unit Makes Noise When Operating - This is an indication of the EA unit not being properly attached to a firm mounting base of wood or concrete with the mounting stands and band clamps provided. It can also indicate that the UV bulb was installed without the required bulb cushion and/or bulb O-Rings. Attach the EA unit correctly to a firm base; install the bulb cushion and/or bulb O-Rings as described in Sec. G.

Water Is Coming Out Of Electrical Enclosure - Water exiting the unit through the electrical enclosure assembly can be attributed to either (a) a bad quartz tube seal (Factory installed), or (b) a broken or cracked quartz tube. Check the quartz tube for cracks or breakage as instructed in Sec. G. Replace the quartz tube assembly if cracks in the quartz tube are found upon inspection.

SPECIFICATIONS:

Due to Delta UV's commitment to product improvement, all product descriptions or specifications are subject to change without notice.



DELTA UV LIMITED WARRANTY

1 Year

Delta Ultraviolet Corporation warrants to every original Purchaser of Delta UV's Series Ultraviolet Unit, that the product will be free from defects, as defined herein, for a period of (1) year. If at any time during the Limited Warranty period, any defect, as defined herein, prevents the product from performing correctly in an application for which it was designed, Delta UV will repair or replace the product (at Delta UV's option) as outlined herein:

COVERED WARRANTY ITEMS:

This Limited Warranty **DOES** cover the UV unit, its components, and defects thereof against:

- Manufacturing Defects
- Material Defects – Ballast (1 year)
- Plastic Component Degradation
- Bulb failure during 1st year (Pro Rated)

NON-COVERED WARRANTY ITEMS:

This Limited Warranty **DOES NOT** cover the following UV unit defects:

- Failure Of Any Covered Condition When Caused By Any Of The Following:
 - Metal Corrosion Due To Salt Water Use
 - Glass Component Breakage
 - Bulb Failure After One Year
 - Operation At Pressures Greater Than 40 PSI (3 Bar)
 - Any Failure Not Indicated As "Covered Warranty Item" Herein
 - Mechanical Abuse
 - Improper Installation
 - Acts of War or God
 - Freeze Damage
 - Improper Operating Voltage

Note 1: During the duration of this Limited Warranty, should any failure occur, the unit should be inspected at the site to determine the cause of failure, and if that failure is shown to be a covered item, the Original End User (User) must request a written Return Merchandise Authorization (RMA) from Delta UV, prior to any product return. Any returned unit is to be accompanied by Delta UV's RMA and is to be returned freight prepaid to Delta UV for Limited Warranty evaluation. The User is responsible for any freight damage associated with such return. Unit failures, or components thereof, found to be covered under this Limited Warranty will be repaired or replaced (at Delta UV's option) without cost to the User and will be returned to the User via UPS Surface at Delta's expense. Delta UV shall be the sole judge in determining the cause of failure of any UV unit. Units arriving in broken condition will not be warranted.

The term "Original End User" (User) shall mean the person or company that was in possession of the physical location where the UV unit was originally installed, at the time of first installation, as evidenced by an original invoice from the selling company to the User at the location where the unit is to be returned. A photo copy of said original invoice must accompany the UV unit RMA paperwork. UV units received unaccompanied by the required documentation will not be accepted by Delta UV for Warranty evaluation and will be returned to the User in the same condition as received, freight collect (COD) if the User fails to provide the required documentation within ten (10) days from date of notification of missing documentation from Delta UV. Any unit returned to Delta UV COD or freight collect will be rejected from the freight carrier.

Note 2: This Warranty is Limited in that it does not cover any monetary reimbursement for freight charges, for removal and/or installation labor, or any other incurred costs by any other person(s) or firm(s), including (but not limited to) any consequential damage or loss of use that might be claimed. The Limited Warranty period shall commence upon the date of sale to the User, but in all cases no later than one hundred twenty (120) days after the date of manufacture of the UV unit, as shown on the Delta UV date code located on the product identification label, whichever occurs first. UV units received with factory identification missing, mutilated or altered, or units received containing components not supplied by Delta UV or modified in any way, will not be warranted under any circumstances.

OTHER RIGHTS - This Limited Warranty supersedes any and all previous Limited Warranties for this product, gives you specific legal rights, and you may have other rights which vary from state to state.

DELTA ULTRAVIOLET CORPORATION
CORPORATE HEADQUARTERS
1535 West Rosecrans Ave
Gardena, CA 90249
Phone 310-323-6400
Fax 310-323-6403

REFERENCE INFORMATION

DEALER.....
.....
.....
.....
PHONE.....
CONTACT.....

DATE OF INSTALLATION.....
MODEL.....
RE-LAMP DATE..... RE-LAMP DATE.....
RE-LAMP DATE..... RE-LAMP DATE.....
RE-LAMP DATE..... RE-LAMP DATE.....
RE-LAMP DATE..... RE-LAMP DATE.....

- NOTES -