



water matters

710A Series Single Station Irrigation Battery Operated Controller

710A-XXX | 710A-ASV-XXX | 710A-011



I N S T R U C T I O N M A N U A L

TABLE OF CONTENTS

INTRODUCTION	1
1. About the controller	1
2. Component identification	2
3. LCD display and controls	4
4. Valve or wall mounting	5
5. Installing the batteries	6
6. Valve adapter installation 710A-000	6
7. In-line valve installation 710A	9
8. Anti-siphon valve installation	10
9. Changing actuator adapters	11
10. Manual valve actuator installation	13
11. Programming	15
12. Setting time and date	15
13. Setting watering frequency	16
14. Setting start times	19
15. Setting watering run times	20
15. Setting the SimpleSmart™ option (set ET)	21
16. Setting seasonal adjustment (monthly budget)	24
17. Rain delay setting	25
18. Events off setting	26
19. Manual watering	28
20. Connecting a rain sensor	29
21. Maintenance, troubleshooting and repairs	30
22. Warranty	32
23. Technical Assistance	33

INTRODUCTION

Thank you for purchasing DIG's 710A-Series Single-Station Battery Operated Controller. This manual describes how to get the 710A-series controller up and running quickly. After reading this manual and becoming familiar with the basic functionality of the controller, use the manual as a reference for less common tasks in the future.

1. ABOUT THE CONTROLLER

The 710A irrigation controller employs the latest irrigation programming features to allow for complete control of any irrigation system and is available assembled on an in-line valve, anti-siphon valve, manual valve actuator, or controller only with solenoid adapters to fit most manufacturers' valves. The 710A series is available in single station with a rain sensor connection, and is powered by two AA batteries that can last up to three years [using name brand alkaline batteries]. The controller is enclosed in a rugged, compact, waterproof housing to protect it from the elements and to ensure a long, trouble-free life.



710A.001
Manual Valve Actuator



710A-000
Solenoid only

710A-ASV-XXX
Anti-siphon valve



710A-XXX
In-line Valve



2. COMPONENT IDENTIFICATION

1. Controller cover
2. Quick reference label
3. LCD displays the icon-based applications / programs
4. Seven-button programming keypad: Use for programming, system on/off, manual run and reviewing program
5. Battery compartment cap for two AA alkaline batteries (not included)
6. Rain sensor yellow wire connection
7. Collapsible 36" solenoid wire
8. DC solenoid with 11/16" UN thread
9. Solenoid adapters
10. Manual flow control
11. 3/4" professional grade in-line valve
12. Solenoid mount adapter
13. Wall/Valve box mounting bracket

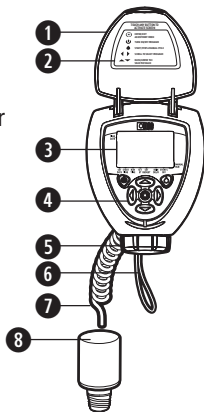

(30-924) (30-922) (30-921) (30-920)

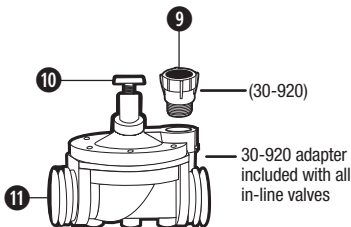
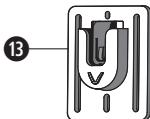
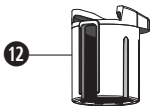
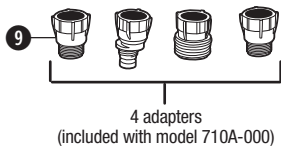

Anti-siphon valve

- 14. Anti-siphon cap
- 15. 3/4" or 1" pipe thread outlet (FNPT)
- 16. Manual flow control knob
- 17. External bleed screw
- 18. 3/4" or 1" pipe thread inlet (FNPT)

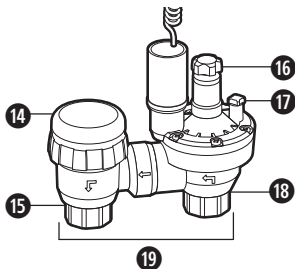

Manual valve actuator

- 20. Manual flow control knob
- 21. External bleed screw
- 22. 3/4" adapter
- 23. 3/4" seat washer
- 24. 3/4" washer
- 25. 1" adapter
- 26. Seat washer
- 27. 1" washer

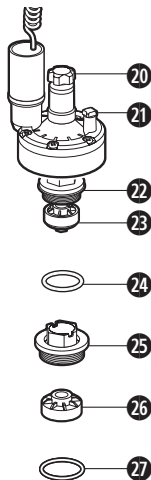

3. LCD DISPLAY AND CONTROLS

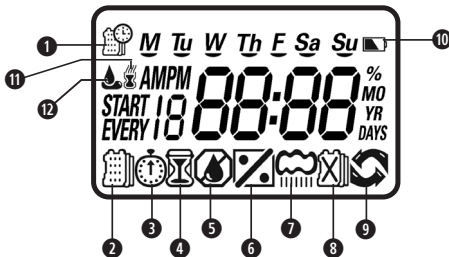

LCD Display

1. **Time and Date** – Indicates current time and day
2. **Set Watering Days** – Choose either specific days, odd/even days, or up to once every 30 days
3. **Start Time** – Up to five start times per day available
4. **Run Time** – Watering duration from 1 minute to 5 hours 59 minutes
5. **Set ET** – Used to set one of the 20 SimpleSmart™ presets
6. **Set Monthly Budget** – Seasonal adjustment setting (5%-200%) in 5% increments or to fine-tune SimpleSmart™ programming
7. **Rain Delay** – Delay irrigation setting from 1 to 99 days with automatic restart
8. **Events Off** – Suspends watering for any month or any specific day within the month.
9. **Manual Run** – Appears when manual button is pushed
10. **Battery Indicator** – Flashes when batteries need to be replaced
11. **Sensor** – Appears only when sensor is connected and active
12. **Watering** – Appears when valve is open

Control Buttons

 Enter/Exit adjustment mode

 Turn On/Off program*

 Start/Stop a manual cycle

 Scroll to select a program setting to adjust

 Raise/Lower the selected value

*NOTE: Turning the controller OFF using the  button will suspend all scheduled programming and OFF will appear on the display. The Manual Run feature will still function when the controller is OFF.

4. VALVE OR WALL MOUNTING

4.1 VALVE MOUNTING

1. Slide the controller **1** into the controller valve mount **2**.
2. Press the controller with the valve onto the solenoid in the desired position.

4.2 WALL MOUNTING

2. Place the mounting plate **4** on the wall and secure using three screws (not included).
3. Slide the controller assembly **3** up and into the mounting plate to secure. (Mounting solenoid sleeve is not used).

NOTE: The length of the controller connecting cable limits the distance between the controller and the solenoid.

Figure A

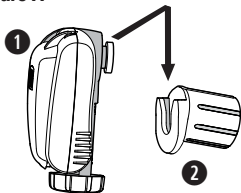
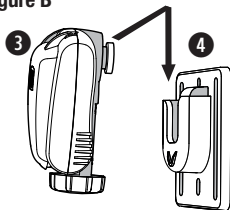
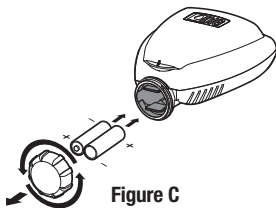

Figure B



5. INSTALLING THE BATTERIES

1. Open the battery compartment cap by turning it counter-clockwise.
2. Install two, fresh, brand name, AA alkaline batteries (not included) and ***note the proper direction of the positive and negative orientation on the underside of the controller.***



3. Insert and screw the battery cap clockwise. Make sure to securely tighten the cover firmly by hand only. The controller display appears with a day, PM, and the hour digit flashing. The controller is ready to be installed and programmed.

6. VALVE ADAPTER INSTALLATION 710A-000







The 710A-000 (only) controller includes four adapters to retrofit Rainbird, Hunter, DIG and Irritrol valves. Follow the instructions below to install.

1. Shut off the main water supply
2. Remove the existing solenoid if applicable.
NOTE: If adapting to an IRRITROL valve, remove the solenoid but **leave the existing solenoid adapter installed.**
3. Select the appropriate solenoid adapter associated with the valve (see chart A).
4. Screw the solenoid adapter into the valve bonnet by hand, tighten with pliers if necessary – but do not over tighten.
5. Thread the 710A-series solenoid into the valve adapter. Hand tighten only.
6. Turn the main water supply on and pressurize the valve; the valve may discharge water momentarily but should then shut off.
7. Test the controller and the installation by pushing the  button (or see section 20) to perform a manual run. To turn the valve on via the solenoid, lift the 710A-series controller from the solenoid and turn the solenoid counter

clockwise 1/2 to 3/4 of a turn, or until you hear or see water flowing through the valve. To turn the water off, turn the solenoid clockwise 1/2 to 3/4 of a turn and wait for the a few seconds for the valve to close.

8. Program the 710A-series controller (see section 11).

CHART A

Model	Compatible Valves
30-920* 	DIG, BERMAD series 200, HIT series 500, DOROT series 80, GRISWOLD series 2000, DW and BUCKNER series VB valves
30-921 INCLUDED 	RAIN BIRD DV, DVF, PGA, PEB (1" only), GB, EFB-CP, BPE, PESB (1" only) and ASVF valves
30-922 INCLUDED 	HUNTER series ASV, HPV, ICV, PGV, SRV, IBV and ASVF valves
30-923* 	WEATHERMATIC series 12000, 21000, 8200CR valves
30-924 INCLUDED 	IRRITROL series 100, 200B, 205, 217B, 700, 2400, 2500, 2600 and TORO series 220, P220 valves
30-925* 	SUPERIOR series 950, HUNTER HBV and TORO series 252 valves (1.5" and larger)
30-926* 	RAIN BIRD SERIES PEB AND PESB

*AVAILABLE THROUGH YOUR DISTRIBUTOR

Figure D

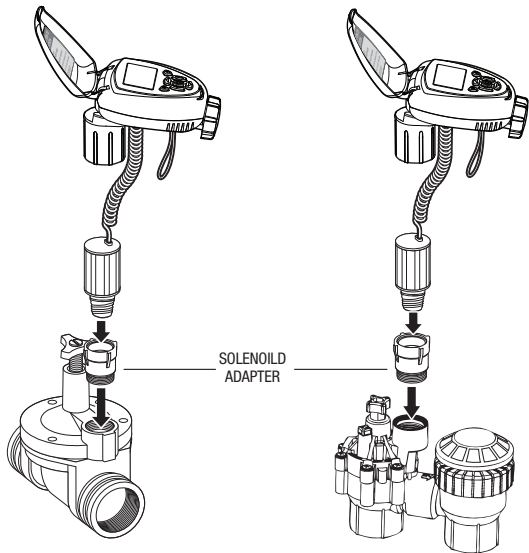

7. IN-LINE VALVE INSTALLATION 710A

Operating pressure: 10-150 PSI

Recommended operating pressure: 10-80 PSI

Warning: Wrap all fittings with Teflon tape. Do not use pipe cement on the valve as this will damage the valve and void the warranty.

1. Shut off main water supply.
2. Install a 3/4" ball or gate valve onto the PVC pipe or to the valve manifold before installing the controller (Figure F and G).
3. Turn water supply on to flush the line and then shut the water off using the ball or gate valve.
4. Wrap the male threads of the PVC adapters with 4-6 layers of Teflon tape, then tighten into the valve with a wrench.
5. Glue fittings to PVC main line and allow to dry.
6. Turn water supply on to pressurize the system. The controller will open momentarily and then will shut off.
7. The unit is now ready to be programmed.

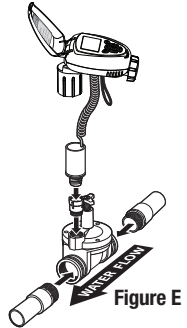

Figure E

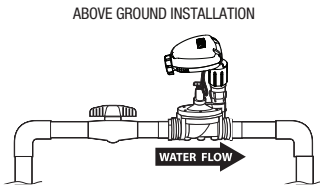

Figure F

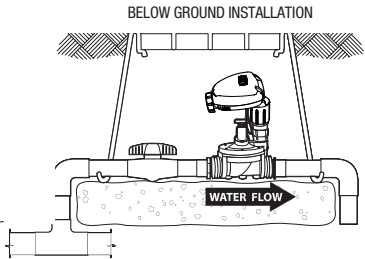

Figure G

8. ANTI-SIPHON VALVE INSTALLATION

Operating pressure: 20-150 PSI

Recommended operating pressure: 10-80 PSI

The 710A-ASV controller can be installed directly to PVC pipe with two PVC male adapters (not included). Inlet 3/4" FNPT, outlet 3/4" FNPT.

NOTE: The 710A-ASV or 710A-011 must be installed at least 6" higher than the highest sprinkler head on the system or back-drainage may occur. Additional control valves must not be installed downstream of the anti-siphon valve. The valve must not be operated continuously for more than 12 hours in any 24-hour period.

Consult local codes for specific details.

1. Flush main line until water runs clear before installation.
2. Shut off main water supply.
3. Install the anti-siphon valve directly to PVC pipe using 3/4" PVC male adapters (Figure H and I) or use 3/4" schedule 80 nipple. The arrow on valve body indicates direction of water flow. (Figure I)

NOTE: Wrap all fittings with Teflon tape. Do not use pipe cement on the valve as this will damage the valve and void the warranty.

Make sure when wrapping fittings with Teflon tape that no excess gets into the internal assembly. Tighten the fittings with a wrench, but do not over tighten.

4. Turn the main water supply on and pressurize the system.

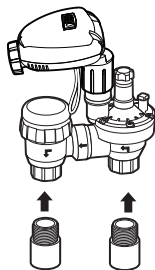

Figure H

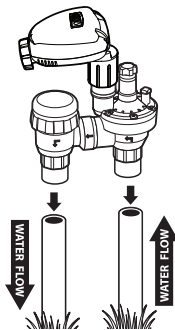





Figure I

- To test the 710A, push the  button. A click will be heard, indicating the valve is open. A droplet icon  on the upper left of the screen and the run time remaining will appear on the display in 5 seconds. Check that the system is operating correctly and push the button again to turn it off. A second click will be heard indicating that the valve closed. The droplet icon  and the manual icon  will disappear from the display and OFF will appear momentarily; then the display will revert to the time of day.
- The unit is now ready to be programmed.

9. CHANGING ACTUATOR ADAPTERS

The 710A-011 controller with actuator is factory set to fit a 3/4" brass manual anti-siphon valve. To install the controller with actuator on a 1" brass or plastic manual anti-siphon valve, the 3/4" seat washer and adapter must be removed and replaced with the 1" adapter and seat washer, which are included in this box.

- Turn the actuator so that the seat washer and the 3/4" threaded adapter face up.
- Using pliers, or a 5/16" wrench, remove the seat washer screw by turning counter clockwise and pull off the 3/4" seat washer assembly (see Figure J).

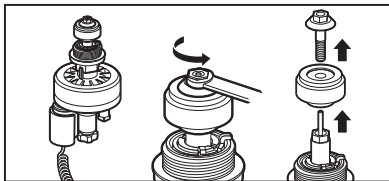

Figure J

- Push the 3/4" threaded adapter down towards the actuator to ease the tension on the retainer clip (see Figure K).

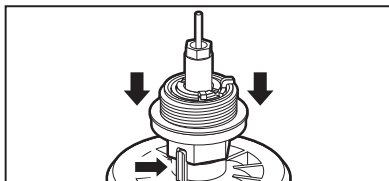

Figure K

4. Next, place your thumb on one side of the retainer clip and with a pair of pliers grip the other side of the retainer clip and pull outwards, away from your thumb, and upwards, removing it from the base of the 3/4" threaded adapter then, remove the adapter (see Figure L).

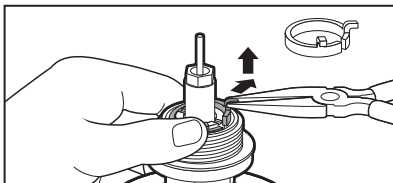

Figure L

5. Install the 1" threaded adapter by pushing it onto the actuator stem and making sure the notch on the adapter lines up with the notch on the stem of the actuator (see Figure M).

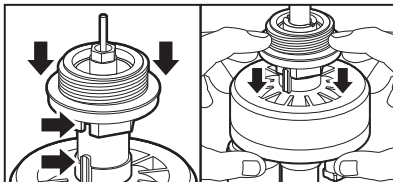

Figure M

6. Spread the retainer clip with your thumbs and push the retainer into the adapter until it clicks (see Figure N).

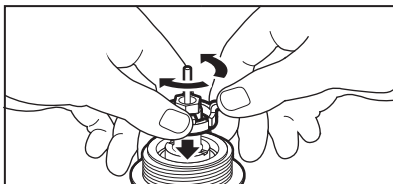

Figure N

7. Install the 1" seat washer assembly as shown. Insert the seat washer screw into the bottom of the actuator stem and tighten turning clockwise (see Figure O).

NOTE: Do not over-tighten.

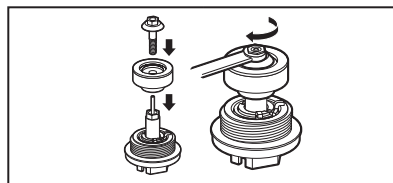

Figure O

10. MANUAL VALVE ACTUATOR INSTALLATION

Operating pressure: 20-125 PSI

Recommended operating pressure: 20-80 PSI

1. Shut off main water supply.
2. Remove the manual stem from the existing valve and temporarily remove the anti-siphon cap (Figure P).
3. Replace any existing worn washers with the new ones provided (Figure Q).
4. Install the actuator into the manual anti-siphon valve body by turning actuator clockwise. Tighten firmly, but do not over tighten (Figure R).

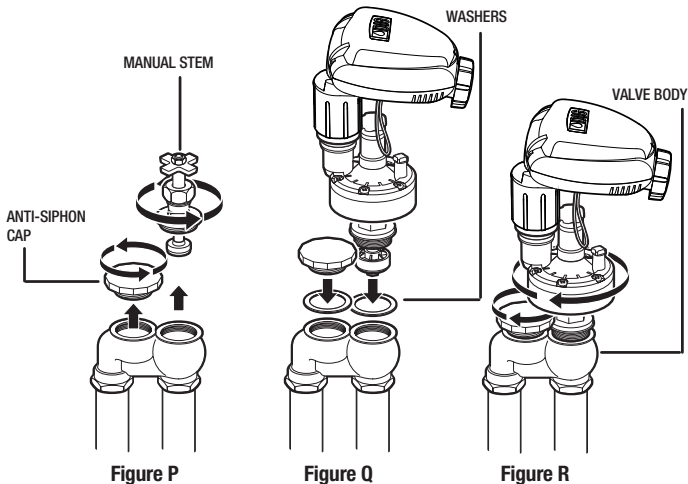

5. Turn actuator flow control knob clockwise until it stops (Figure S).
6. Turn on main water supply.
7. Activate the solenoid through the controller manual button, a click will be heard indicating the valve is open (The manual symbol will appear on the display).
8. Turn the actuator flow control knob counter clockwise to allow flow and check the system to make sure that the sprinklers or the drip system is working properly (Figure T).

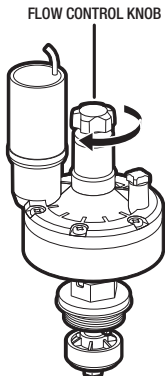

Figure S

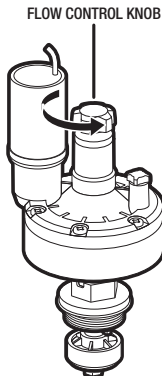

Figure T

9. De-activate the solenoid through the controller's manual button, a faint click will be heard and the valve will close. (The manual symbol will disappear and water flow will stop). If flow continues, **turn flow knob clockwise, one full turn at the time until flow is stopped, and the valve is shut off.**
10. Repeat steps 7 and 9 and make sure that flow is turned on and off.
Note: Turn the flow control knob clockwise to decrease flow, counter-clockwise to increase flow. For low-flow drip systems below 60 gallons per hour, the flow control knob should be turned no more than 1 to 3 turns up (counter-clockwise) from the fully closed position.
11. The unit is now ready to be programmed.

11. PROGRAMMING

This section explains the programming features and the steps necessary to assign irrigation schedules. To program the controller use the ◀ or ▶ buttons to select the desired programming mode, then push Ⓞ to make the entry flash and the ▼ ▲ buttons to change the value. Only a flashing value can be changed.

NOTE: If the last data entered stops flashing, push Ⓞ again to resume programming and repeat the steps.

12. SETTING TIME AND DATE

The controller can display the time in either a 12 or 24 hour format. To change the time format, from the current time:





1. Push and hold the ▼ button for three seconds until the display switches format (AM/PM disappears).



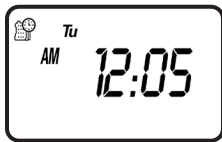



SETTING THE CURRENT TIME AND DATE

To enable the controller to operate properly, the current time and date must be set.

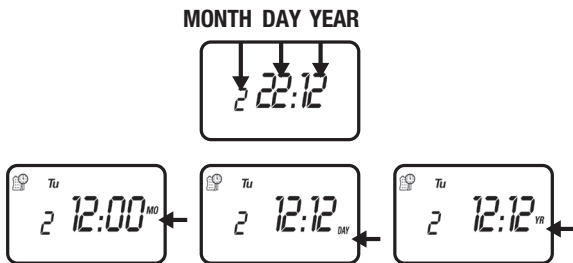

1. Push  to select the hour and adjust using  . AM/PM is changed by increasing or decreasing the hour.
2. Continue to push  to set the minutes, and current month, day, then year.



3. Push  to confirm your settings. The current day is selected automatically. Push  to proceed to the next step Set Days .





13. SETTING WATERING FREQUENCY

This setting determines which days the 710A controller will operate. Choose either watering on specific days of the week, Even/Odd days, hourly, from every 1 to 12 hours, or daily cyclical from once a day up to every 30 days. The controller's default setting is to water on all specific days of the week (all days are underscored).

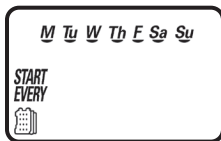
Option 1 – Setting Specific Days of the Week:

1. Push  to select Set Days . By default all days are set to water.



2. Push  and M will begin to flash. Advance through days of the week using  . Deselect or select a day to water using  .

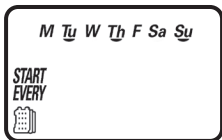





F WATERING DAY

F NON-WATERING DAY

3. Push  to confirm your settings.

Option 2 – Setting Even or Odd Days:

1. Push  to select Set Days .







2. Push  and M will begin to flash then advance through days of the week using  until Even appears flashing, push   to select Odd.



3. Push  to confirm your settings.

Option 3 – Watering once every X hours (cyclical watering)







Please note that only 1 start time is available in this mode.

1. Push  to select Set Days .
2. Push  and M will begin to flash then advance through days of the week using  until  appears flashing.
3. Push   to select to water once every 1 to 12 hours.



4. Push  to confirm your settings.











Option 4 – Watering once every X days (cyclical watering)

1. Push  to select Set Days .
2. Push  and M will begin to flash then advance through days of the week using  until 1 DAY appears flashing.
3. Push   to select to water once every 1 to 30 days.



4. Push  to confirm your settings.

To set the controller back to specific days mode:

1. Push  to select Set Days . Previously selected days will be saved.
2. Push  and then push  until the days of the week can be seen at the top of the LCD screen.
3. Push  and advance through days of the week using   and select each day to water using  .
4. Push  to confirm your settings.

Push the  button to proceed to the next step Start Time .







14. SETTING START TIMES

The 710A controller can have up to five separate irrigation start times per day.

1. Push  to select Start Time . By default Start Time 1 is set to 6:00 AM.





You can view all start times by pushing  .







2. Push  to select the hour and adjust using   then push  to set minutes.
3. Push  to confirm your settings.
4. To set additional start times push  then push  through the hours and minutes to the next desired Start Time. Up to 5 start times can be programmed.

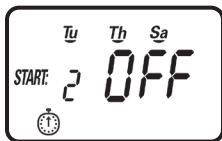

Note: Only 1 start time is available in hourly cyclical mode. The 710A will begin hourly cyclical mode upon arriving at the set start time. The start time will then update to show the next time the 710A will start defined by what hourly program is set.

To delete a start time:

1. Push  to select Start Time  and push  to enter adjustment mode.
2. Push  or  to advance the hours until the display shows OFF.



3. Push  to confirm your settings and scroll through to review all start times by pushing  .

Push the  button to proceed to the next step Run Time .







NOTE: In hourly cyclical mode, Run Time is limited to 59 minutes.

15. SETTING WATERING RUN TIMES

Note: If you have already set a SimpleSmart™ ET preset (example: SP02) and then change the run time, your SimpleSmart™ program will be turned OFF. You must reactivate the SimpleSmart™ programming each time you adjust your run time (see section 16).

This setting determines the length of time the 710A controller will allow the valve to remain open (duration is from 1 minute up to 5:59 hours). For example, setting watering run time to 10 minutes on certain days of the week will program the controller to turn the water on for 10 minutes on each of the days chosen and at every start time selected.

To set the watering run time :

1. Push  to select Run Time . By default the Run Time is set to 5 min.
2. Push  to select the hour and adjust using   then push  to set the minutes.

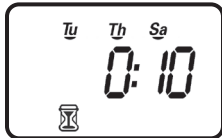

3. Push  to confirm your settings.

Push the  button to proceed to the next step Set ET .

16. SETTING THE SIMPLESMART™ OPTION (SET ET)

The 710A controller's main feature includes 20 preset programs for sprays and drip irrigation based on three years of historical evapotranspiration (ET) from various climate regions.

How DIG's 710A controller operates using Historical Evapotranspiration (ET):

After programming the watering schedule, watering start time and watering duration, the user can select one of the preset SimpleSmart™ evapotranspiration (ET) programs for spray or drip irrigation systems. Reference CHART B on page 22 and choose from the region description.

Selecting SP01 through SP20 sets the 710A controller to water a predetermined number of minutes per month. The amount to water is pre-programmed into the controller and is determined by which program (SP) is selected and by the month.

NOTE: If you have already set a SimpleSmart™ ET preset (example: SP02) and *then* change the run time, your SimpleSmart™ program will be turned OFF. You must reactivate the SimpleSmart™ programming each time you adjust your run time.

NOTE: If using one of the SimpleSmart™ presets we recommend evaluating the plants' health for the first month and making adjustments to the system as needed. If an adjustment or fine tuning of the SimpleSmart™ programming is required, this adjustment can be made for each month in the SEASONAL ADJUSTMENT (%) SETTING (see section 17).

CHART B - SELECTING HISTORICAL ET PROGRAM

PROGRAM	REGIONS	IRRIGATION METHOD
SP01	Cool Mediterranean	Drip Systems
SP02	Cool Mediterranean	Sprinkler Systems
SP03	Humid Continental	Drip Systems
SP04	Humid Continental	Sprinkler Systems
SP05	Warm Mediterranean	Drip Systems
SP06	Warm Mediterranean	Sprinkler Systems
SP07	Humid Sub-Tropical	Drip Systems
SP08	Humid Sub-Tropical	Sprinkler Systems
SP09	Highlands	Drip Systems
SP10	Highlands	Sprinkler Systems
SP11	Dry Inland Valleys	Drip Systems
SP12	Dry Inland Valleys	Sprinkler Systems
SP13	Tropical Wet & Dry	Drip Systems
SP14	Tropical Wet & Dry	Sprinkler Systems
SP15	Tropical Wet	Drip Systems
SP16	Tropical Wet	Sprinkler Systems
SP17	Semi-Arid	Drip Systems
SP18	Semi-Arid	Sprinkler Systems
SP19	Arid	Drip Systems
SP20	Arid	Sprinkler Systems

For example:

The user entered watering run time will be adjusted monthly based upon the forecast ET pattern for the selected region.



By selecting SP02, the controller may adjust the programmed run time of 10 minutes in the month of January to 3 minutes, or less. This reduces the irrigation run time by 7 minutes, providing a water savings of nearly 70% for the month of January.

To activate the SimpleSmart™ ET feature:

1. Push  to select Set ET .







2. Push  and OFF (or the last SP program #) appears flashing.



3. To select a desired SimpleSmart™ preset push  or  and select one of the twenty programs from the list using one that is similar to your climate region and irrigation method (see map in centerfold or reference Chart B).

4. Push  to confirm our selection.



To deactivate the preset program:

1. Push  and the program # appears flashing.
2. Push  or  until OFF appears.
3. Push  to confirm settings.

Push the  button to proceed to the next step Set Budget .

17. SETTING SEASONAL ADJUSTMENT (MONTHLY BUDGET)

The Seasonal Adjustment percentage feature can be utilized to alter the programmed watering run time on a monthly basis.

This program features two options:



- A.** It can be used as an adjustment to the programmed run time by altering the programmed watering duration on a monthly basis.
- B.** It can be used to modify the total run time setting of the SimpleSmart™ programming per month by percentage.

To set seasonal adjustment in %:

1. Push  to select Set Budget .

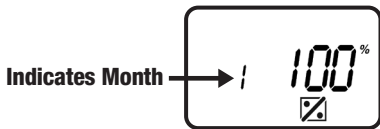
You can review all monthly budgeting settings by pushing  .





2. Push the  button and the 100% appears flashing.
3. To set the desired seasonal adjustment % (5-200%), Push  or .

Example, if a 20-minute duration is programmed, and then the monthly budget is changed from 100% to 50%, the duration will now be 10 minutes for the selected month.



4. Repeat the steps to set the desired seasonal adjustment % for each month by pushing  and following the previous steps for each month.

5. Push  to confirm settings.



Push the  button to proceed to the next step Rain Delay .

18. RAIN DELAY SETTING

Used to shut down controller in winter or when it is raining. Set schedules will be retained and programmed watering will resume after the set delayed time is completed. The Rain Delay feature can also be used to set the start day in cyclical mode.

1. Push  to select Rain Delay .



2. Push  then adjust to the number of days to suspend watering using  .

You can set up to 99 days.



3. Push  to confirm your settings.



To cancel the Rain Delay, set the days to OFF using ▼▲.

Note: OFF appears in between numeric value of 99 and 1.

Push the ► button to proceed to the next step Events Off ☒.

19. EVENTS OFF SETTING

This mode allows the user to program the controller to not water during specific months of the year, or to program the controller to not water on specific days of the week during a specific month.

To turn off specific days within a month:

1. Push ► to select Events Off ☒.

You can review all events off settings for each month by pushing ▼▲.

2. Push ⦿ and advance through the days of the week using ► until the desired month is selected and DAYS is displayed on the right side of the screen. The number of the month is on the left (1 = January, 12 = December).

3. Push the ► button until the desired day of the week flashes.

4. Push the ▼ to remove the underline under the day of the week.

During the selected month, watering will not occur on the days of each week without the underline.

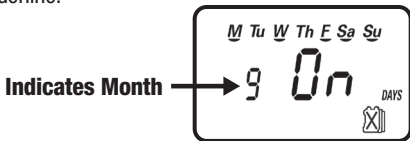



5. Push ⦿ to confirm settings.

To turn off an entire month:

1. Push  to select Events Off .

You can review all events off settings by pushing  .

2. Push  and advance through each day of the week using  until the desired month and MO is displayed on the right side of the screen.

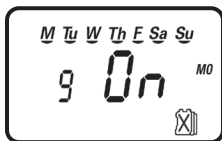

3. Push the  button and the word OFF will appear. The selected month is now turned off, and no watering will occur during the entire month.

4. Push  to confirm your settings.

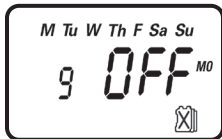

The controller is now fully programmed.









Here is an example of the home screen showing all the icons of the programs that are currently set and active, which are the SimpleSmart™ (**SET ET**), monthly budget, rain delay and events off programs. If OFF appears on this screen programmed watering will not occur until  is pressed (current time will be displayed).

20. MANUAL WATERING

The manual mode allows the user to test the system and water for a specified run time. The controller will automatically close the valve at the end of the defined irrigation period. The originally programmed irrigation schedules will continue to function at the times assigned. The sensor condition and OFF mode is disregarded in this mode.

To start a manual run,

1. Push the  button, and the  icon and  icon appears. ON appears momentarily and then the last watering run time is displayed with  . The controller will open the valve and in 3-5 seconds a count down of the remaining irrigation run time appears, showing when the controller will close the valve. The default run time is 5 minutes. Adjust to the desired manual run time length by pushing  .



2. Push the  button to end manual run.
3. After 3-5 seconds the display will revert to the current time screen.

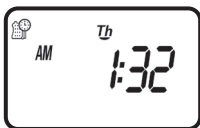

21. CONNECTING A RAIN SENSOR

Most “normally closed” rain or soil moisture sensors can be connected to the 710A controller. The function of the sensor is to prevent automatic watering by the set program due to excessive rainfall or when the soil is too moist.

To connect the sensor to the controller, please follow these steps:

1. Cut the yellow wire loop that exits the controller in the middle of the loop.
2. Strip approximately 1/2” of insulation from the end of each wire.
3. Splice one yellow wire to each of the wires coming from the sensor.
Use waterproof wire connectors to secure the connections.
4. Follow the sensor manufacturer’s instructions for calibrating the sensor.
5. When the sensor is active and preventing automatic operation, a  icon will appear on the display.

The icon will only appear when the sensor is active.

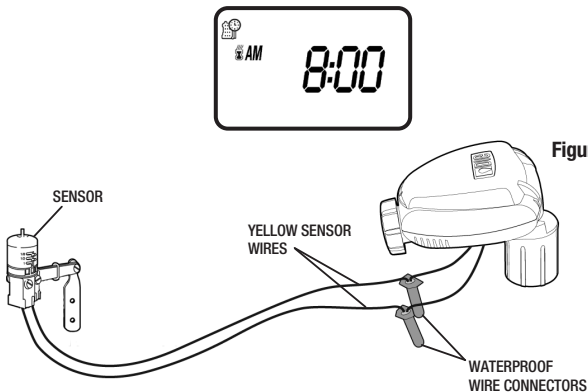





Figure V

Recommended rain sensors are the Rain Bird RSD and Hunter Mini-Clik
Recommended soil moisture sensor is the Irrrometer WEM-B

To restore the controller to the default settings

1. Push the  button until **START EVERY** is displayed and the  icon appears on the bottom left of the screen.
2. Push and hold down the  button for three seconds.
3. The screen returns to the home screen (clock) and all the default settings are restored. The current time and date is retained.

22. MAINTENANCE, TROUBLESHOOTING AND REPAIRS

PROBLEM: Valve is not opening automatically or manually

CAUSE: No water pressure

SOLUTION: Open main water supply valve

CAUSE: Faulty solenoid

SOLUTION: Replace solenoid

CAUSE: Flow control handle is turned down

SOLUTION: Open flow control handle on valve

PROBLEM: Valve functions in manual mode but not automatically

CAUSE: Controller is set to OFF mode

SOLUTION: Verify that controller does not show OFF in current time mode

CAUSE: AM/PM not set correctly in current time mode

SOLUTION: Check current time, change AM/PM if necessary

CAUSE: AM/PM not set correctly in start time mode

SOLUTION: Check start time(s), change AM/PM if necessary

CAUSE: Watering restriction or rain delay is preventing watering

SOLUTION: Remove watering restrictions or set rain delay to off

CAUSE: Yellow sensor wires have been cut

SOLUTION: Re-connect sensor wires together with waterproof connector

CAUSE: Sensor is installed and is in a state that prevents watering

SOLUTION: Check sensor and wire splices and verify sensor is normally closed

PROBLEM: The display is blank

CAUSE: No buttons have been pushed in the previous 15 minutes

SOLUTION: Push any button

PROBLEM: Valve fails to close

CAUSE: Valve is installed backwards

SOLUTION: Check flow arrow and verify arrows points away from water source

CAUSE: Debris is blocking solenoid port

SOLUTION: Shut off water supply, unscrew and remove solenoid, then open water supply and flush out solenoid port, re-install solenoid

PROBLEM: Rain sensor does not prevent watering

CAUSE: Rain sensor is normally open, malfunctioning, or not wired correctly

SOLUTION: Verify that sensor icon appears on display when pin is pushed down & check all wire splices

PROBLEM: Controller waters more than once per day

CAUSE: More than one start time has been programmed

SOLUTION: Change start time 2,3,4 and 5 to OFF

PROBLEM: Solenoid is not fully closed after using manual operation.

SOLUTION: Lift the controller and turn solenoid clockwise to fully closed position.

PROBLEM: Solenoid or adapter O-rings are damaged or twisted.

SOLUTION: Turn off the water supply. First turn the solenoid counter-clockwise to remove and inspect the O-ring, and then turn it counter-clockwise and repeat the inspection. Clean any debris or replace the O-ring as necessary.

For more troubleshooting assistance please visit www.digcorp.com or call 760-727-0914.

23. WARRANTY

DIG CORPORATION warrants these products to be free from defects in material and workmanship for a period of three years from date of purchase. This warranty does not cover damage resulting from accident, misuse, neglect, modification, improper installation or subjection to line pressure in excess of DIG CORPORATION'S recommendations. This warranty shall extend only to the original purchaser of the product for use by the purchaser.

The obligation of DIG CORPORATION under this warranty is limited to repairing or replacing at its factory this product which shall be returned to the factory within three years after the original purchase and which on examination is found to contain defects in material and workmanship. **DIG CORPORATION SHALL IN NO EVENT BE LIABLE FOR ANY INCIDENTAL OR CONSEQUENTIAL DAMAGES OF ANY KIND; THE SOLE OBLIGATION OF DIG IS LIMITED TO REPAIR OR REPLACEMENT OF DEFECTIVE PRODUCTS. SOME STATES DO NOT ALLOW THE EXCLUSION OR LIMITATION OF INCIDENTAL OR CONSEQUENTIAL DAMAGES, SO THE ABOVE LIMITATION OR EXCLUSION MAY NOT APPLY TO YOU.**

Unattended use for prolonged periods without inspection to verify proper operation is beyond the intended use of this product, and any damage resulting from such use shall not be the responsibility of DIG CORPORATION. There are no warranties, which extend beyond the description on the face hereof. In the case of purchase of the product for use other than, for irrigation purposes, DIG CORPORATION hereby disclaims any implied warranties including any warranties of merchantability and fitness for a particular purpose. In the case of the purchase of the product for personal, family or household purposes, DIG CORPORATION disclaims any such warranties to the extent permitted by law. To the extent that any such disclaimer or implied warranties shall be ineffectual, then any implied warranties shall be limited in duration to a period of three years from the date of the original purchase for use by the purchaser. Some states do not allow limitation on how long an implied warranty lasts, so the above limitation may not apply to you.

In order to obtain performance under this warranty, the unit must be returned to the factory, along with proof of purchase indicating original date of purchase, shipping prepaid, addressed as follows:

DIG CORPORATION, 1210 Activity Drive, Vista, CA 92081. Repaired or replaced units will be shipped prepaid to the name and address supplied with the unit returned under warranty. Allow four weeks for repairs and shipping time. Repair of damaged units not otherwise within warranty may be refused or done at a reasonable cost or charge at the option of DIG CORPORATION.

This warranty gives you specific legal rights, and you may also have other rights, which vary from state to state.

24. TECHNICAL ASSISTANCE

Should you encounter any problem(s) with this product or if you do not understand its many features, please refer to this instruction manual first. If further assistance is required, DIG offers the following customer support:

TECHNICAL SERVICE USA

- DIG's Technical Service Team is available to answer questions in from 8:00 AM to 5:00 PM (PST) Monday-Friday (except holidays) at 760-727-0914.
- Questions in English and Spanish can be emailed to: questions@digcorp.com or faxed to 760-727-0282.
- Specification documents and manuals are available for downloading in English and Spanish at www.digcorp.com.



1210 Activity Drive
Vista, CA 92081-8510, USA

www.digcorp.com
email: dig@digcorp.com

26-246 REVC 012318
Printed in the USA

DIG is a Registered Service Mark of DIG Corporation

