

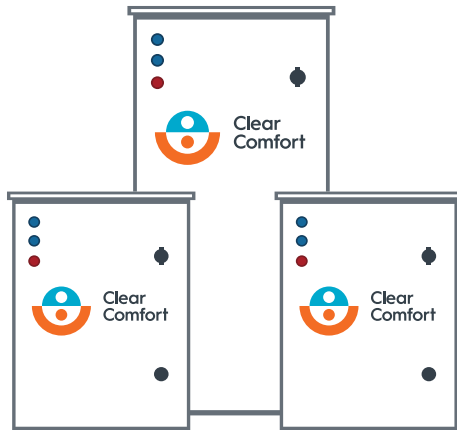

COMMERCIAL MANUAL

Clear Comfort Commercial Pool & Spa Systems

Patented Hydroxyl-Based Advanced Oxidation (AOP)
Installation, Operations & Maintenance Manual



IMPORTANT SAFETY INSTRUCTIONS



For the latest manual
version, scan the QR code or visit:
clearcomfort.com/commercial-manual



We're here to help

Have questions? For assistance, contact us:

☎ 303.872.4477

✉ support@clearcomfort.com

🌐 clearcomfort.com/help

For the latest manual
version, scan the QR code or visit:
clearcomfort.com/commercial-manual



TABLE OF CONTENTS



WARRANTY	2
GENERAL INFORMATION	3
Important Safety Instructions.....	3
Electrical Safety	4
Grounding	4
General Safety	4
STANDARD CLEAR COMFORT SYSTEM DESCRIPTIONS	5
Key Features	5
Standard Specifications	5
Operating Ranges.....	5
INSTALLATION PREREQUISITES	8
Clear Comfort Supplied Materials	8
Recommended Materials And Tools	8
INSTALLING THE CLEAR COMFORT SYSTEM	9
System Installation - Location.....	9
System Installation - Electrical.....	9
Full System Diagram With Booster Pump	10
Full System Diagram With Inline Diffuser Installation Kit	11
Full System Diagram With Surge Pit Diffuser Installation Kit	12
System Installation - Connecting System and Venturi Loop.....	13
OPERATING INSTRUCTIONS	16
Air Flow Meter.....	17
SYSTEM MAINTENANCE	18
Cartridge Replacement	18
Backwashing Instructions	20
WIRING DIAGRAM	21
Wiring Into Pump Electrical Circuit	22
Wiring To a Standalone Electrical Outlet	22
APPENDIX	23
Head Loss (Without Booster Pump).....	23

WARRANTY

Clear Comfort warrants all Equipment to be free from defects in material or workmanship under normal use and service. Clear Comfort, Inc. at its discretion may repair or replace the Equipment or parts thereof. The Company's warranty does not cover any Equipment that has been altered or changed in any way by any person not authorized by Clear Comfort, INC.

THIS CONSTITUTES THE SOLE WARRANTY MADE BY CLEAR COMFORT, INC. EITHER EXPRESSED OR IMPLIED. THERE ARE NO OTHER WARRANTIES EXPRESSED OR IMPLIED WHICH EXTEND BEYOND THE FACE HEREOF, INCLUDING THE IMPLIED WARRANTIES OF MERCHANTABILITY AND FITNESS FOR A PARTICULAR PURPOSE. IN NO EVENT WILL CLEAR COMFORT, INC. BE LIABLE FOR ANY INCIDENTAL OR CONSEQUENTIAL DAMAGES AND CUSTOMER'S REMEDIES ARE LIMITED TO REPAIR OR REPLACEMENT OF NONCONFORMING CLEAR COMFORT SYSTEMS OR PARTS.

This equipment was inspected before shipment from our plant. To original purchasers of this equipment, Clear Comfort Water Inc. ("Clear Comfort"), warrants its Clear Comfort Systems to be free from defects in materials and workmanship for a period of FIVE (5) years from the date of purchase. Replacement Cartridges and cylinders are warranted for a period of ONE (1) year from the date of purchase.

Parts which fail or become defective during the warranty period, except as a result of freezing, negligence, improper installation, use, or care, shall be repaired or replaced, at our option, without charge, within 90 days of the receipt of defective product, barring unforeseen delays.

To obtain warranty replacements or repair, defective components or parts should be returned, transportation paid, to the place of purchase, or to the nearest authorized Clear Comfort service center. For further Clear Comfort dealer or service center information, contact Clear Comfort customer service department.

Clear Comfort shall not be responsible for cartridge, removal and/or re-installation labor or any other such costs incurred in obtaining warranty replacements.

The Clear Comfort Products warranty does not apply to components manufactured by others. For such products, the warranty established by the respective manufacturer will apply.

This warranty shall be voided if at any time: (i) Customer attempts to make any internal changes to any of the components of the Equipment; (ii) the power supplied to any part of the Equipment exceeds the Equipment's operating parameters; (iii) any external device attached by Customer creates conditions exceeding the Equipment's operating parameters; (iv) the Equipment is tampered with; or (v) the serial number is covered, removed or defaced. Clear Comfort, Inc. reserves the right to seek damages if its system is tampered with, reverse engineered, or if Customer takes any other actions to interfere with the operation or integrity of the Clear Comfort system.

No Other Warranties

To the maximum extent permitted by applicable law, Clear Comfort disclaims all other warranties, either expressed or implied, including, but not limited to, implied warranties of merchantability and fitness for a particular purpose, with regard to the product(s), part(s) and/or any accompanying written materials.

Procedure for Obtaining Performance

In order to obtain the benefits of this warranty, the customer who made the original retail purchase must contact the Clear Comfort Technical Service Department as soon as possible after discovery of the product-related issue, but in no event later than the expiration date of the respective warranty periods provided herein. Upon receipt of this communication, Clear Comfort will promptly notify the customer of the address to which the product may be shipped. The customer shall then ship the product, freight prepaid, to the address indicated, together with a "RETURN GOODS AUTHORIZATION" form obtained from Technical Service and a brief description of the problems encountered. Unauthorized returns will not be accepted. Freight must be prepaid by customer.

Warranties or Representations by Others

No third party has any authority to make any warranties or representation concerning Clear Comfort or its products. Accordingly, Clear Comfort is not responsible for any such warranties or representations.

To activate & validate your warranty, you must submit your warranty card or fill out our warranty form on clearcomfort.com/warranty within 1 year of your ship date from Clear Comfort

GENERAL INFORMATION

IMPORTANT SAFETY INSTRUCTIONS

1. READ AND FOLLOW ALL INSTRUCTIONS.**2. For cord connected/convertible units:**

DANGER – Risk of injury.

a. Replace damaged cord immediately.

b. Do not bury cord.

c. Connect to a grounding type receptacle only.

3. For all permanently connected units intended for use on 15 or 20 ampere, 125 volt or 240 volt, single phase branch circuits:

WARNING – Risk of Electric Shock. Connect only to a branch circuit protected by a ground-fault circuit-interrupter (GFCI). Contact a qualified electrician if you cannot verify that the circuit is protected by a GFCI.

4. For all cord connected units other than storable pool pumps: **WARNING** – Risk of Electric Shock. Connect only to a grounding type receptacle protected by a ground-fault circuit interrupter (GFCI). Contact a qualified electrician if you cannot verify that the receptacle is protected by a GFCI.

5. For all permanently connected units: **WARNING** – Risk of Electric Shock. Connect only to a branch circuit protected by a ground-fault circuit-interrupter (GFCI). Contact a qualified electrician if you cannot verify that the receptacle is protected by a GFCI.

6. For units intended for above-ground storable swimming pools: Do not bury cord. Locate cord to minimize abuse from lawn mowers, hedge trimmers, and other equipment.

7. For all cord and plug connected units: **WARNING** – To reduce the risk of electric shock, replace damaged cord immediately.

8. For units intended for above ground storable swimming pools: **WARNING** – To reduce the risk of electric shock, do not use extension cord to connect unit to electric supply; provide a properly located outlet.

9. When the modified air is introduced into the pool or spa water via the

existing plumbing, the biocide is produced. Some of the remaining activated atoms either keep minerals dissolved in the water or remove minerals that were previously deposited.

10. This unit is to be installed in accordance with the installation instructions, the applicable plumbing and building codes, the applicable state and local laws and regulations, and the requirements of the Authority Having Jurisdiction.

11. When installing and using this equipment, basic safety precautions should always be followed including the following.

12. WARNING - To reduce the risk of injury, do not permit children to use this product unless they are closely supervised at all times.

13. WARNING - Do not sit or stand on unit.

14. WARNING: UV radiation is dangerous for the eyes and skin. Do not operate the UV-C emitter outside the appliance. (IEC 60335-2-109).

15. If it is intended that replacement of the UV-C emitter can be carried out by the user, the appliance is marked with "Read the instructions" or with symbol ISO 7000-0790 (2004-01). (IEC 60335-2-109).

16. Appliance contains a UV-C emitter. (IEC 60335-2-109).

17. Unintended use of the appliance or damage to the housing may result in the escape of dangerous UV-C radiation. UV-C radiation may, even in little doses, cause harm to the eyes and skin. (IEC 60335-2-109).

18. Appliances that are obviously damaged must not be operated. (IEC 60335-2-109).

19. WARNING - Replacement of the UV-C emitter is NOT allowed by anyone other than Clear Comfort.

20. Appliance must be disconnected from the supply before replacing the UV-C emitter. (IEC 60335-2-109).

21. SAVE THESE INSTRUCTIONS.

ELECTRICAL SAFETY

- Do not service the machine when the power is ON.
- The power supply wire gauge and insulation must meet the temperature and power requirements.
- To avoid personal injury never touch exposed electrical connections or components while the power is ON.
- Do not install/service the Clear Comfort system if you or the machine is standing in water with the power ON.
- Protect the power cord from being walked on or pinched, particularly at plugs and the point where they exit from the system.
- The device must be properly connected to the correct power source (either 60Hz 120Vac or 240Vac) using the supplied power cord in accordance with the local electrical code. If possible the unit should be hardwired to the pump circuit and controlled by the pump circuit (rather than hardwiring, an appropriate 120Vac or 240Vac receptacle outlet and plug may be used to connect to the pump controlled circuit).
- If the unit is being wired to standalone AC power (i.e., not through the pump circuit on either 120Vac or 240Vac) it should be installed with its own timer circuit and plugged in through a Ground Fault Circuit Interrupt (GFCI) and the timer should be set to reflect the pool or tub’s hours of operation. Regardless if hardwired or standalone connected, the electrical connection must be made in accordance with the local electrical code.

GROUNDING

The Clear Comfort, Inc. system must be properly grounded. An electrical ground connection to a reliable earth ground is essential for safe operation. Without an electrical ground, all accessible conductive components (including knobs and controls that appear insulated) can render an electrical shock.

GENERAL SAFETY

Use personal protective equipment (steel toe shoes, hearing protection, eye protection) when installing the Clear Comfort system. Follow ladder safety requirements.



STANDARD CLEAR COMFORT SYSTEM DESCRIPTIONS

KEY FEATURES

This manual describes how to install, operate, and maintain the commercial Clear Comfort system, models CCW300 and CCW500. The installation takes one to four hours with little or no disruption to a facility's recirculation or electrical systems. The Clear Comfort system immediately starts to work on a facility of any size. The pool or spa water still needs to be tested and maintained (pH, alkalinity, calcium hardness, cyanuric acid etc.), as would be done with any chemical system.

STANDARD SPECIFICATIONS

The CCW300 Clear Comfort system can be pole or wall mounted. Holes on the back panel can be drilled to meet your installation requirements. The CCW500 Clear Comfort system is floor standing and should not be wall mounted, but it can be secured to floor for seismic safety.

A 10 ft. power cord is included. The system is normally tied to the circuit controlling the pump operations or is plugged into a GFCI protected outlet. See the specification label on inside of door.

- **Weight:**
 - CCW300/CCW300A: 40 lbs.
 - CCW500: 90 lbs.
- **Installation Location:** Unit must be installed within 15 feet from the venturi injection site and mounted in a clean, protected area.
- **Ambient Temperature:** 40°F – 90°F (5°C – 40°C)

OPERATING RANGES

Parameter	CCW300A	CCW300	CCW500
Flow Rates (Max)	350 GPM	700 GPM	2,000 GPM
Power	20 Watts	40 Watts	120 Watts
Current Sensor	0.25 Amp to 15 Amp		0.25 Amp to 15 Amp
Electrical Requirements	120V, 60Hz or 240V, 60Hz*		120V, 60Hz or 240V, 60Hz*
Electrical Rating	120V, 60Hz, 1.5 Amp or 240V, 60Hz, 0.75 Amp*		120V, 60Hz, 2.5 Amp or 240V, 60Hz, 1.25 Amp*

* See the specification label on inside of door

NOTE: CLEAR COMFORT SHOULD ONLY RUN WHEN THE PUMP IS OPERATING.

CCW300

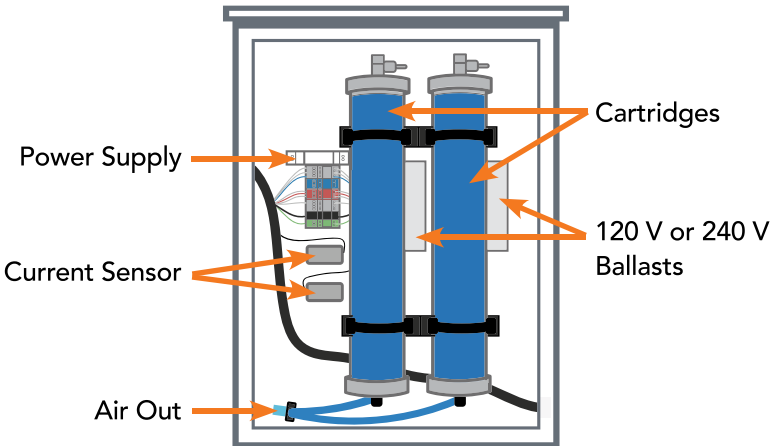
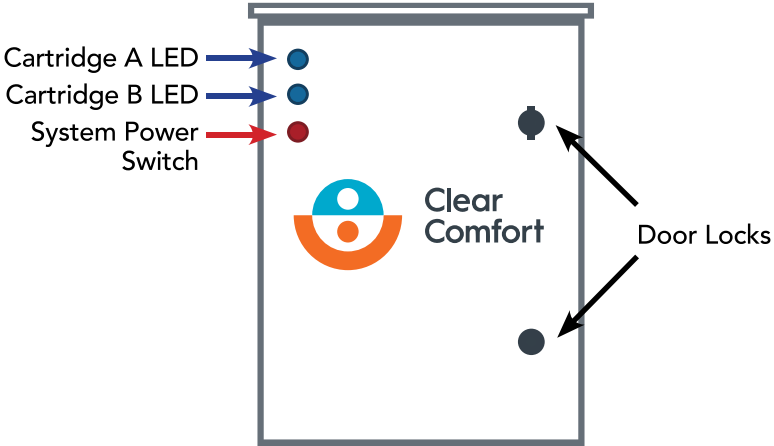

CCW500

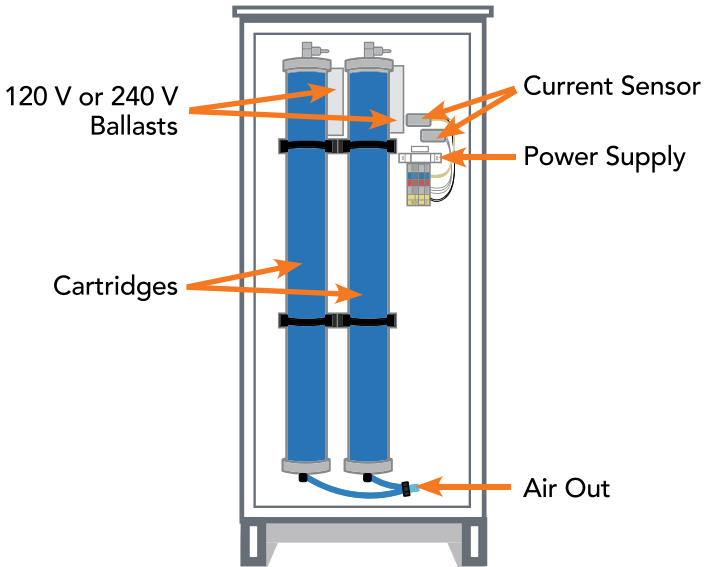
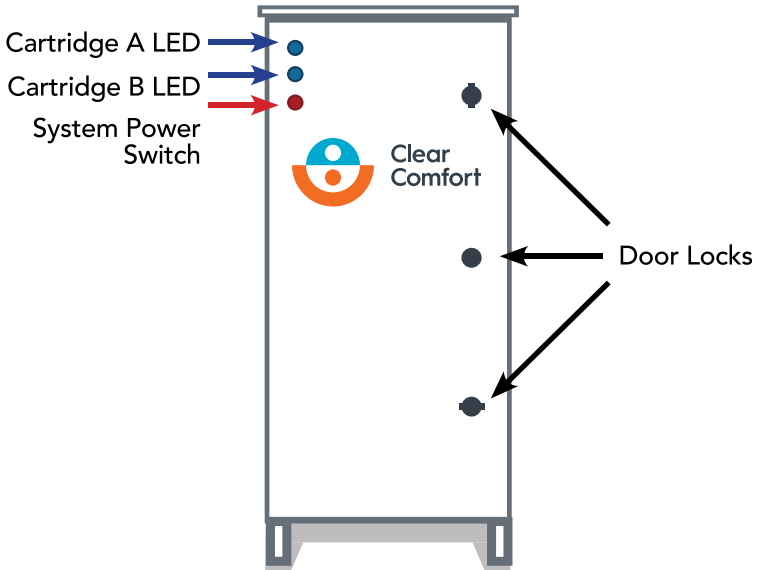

INSTALLATION PREREQUISITES

Prior to installation, a site survey should be performed to validate the correct system parameters are in place and ready to be installed. We recommend compliance within the following operating ranges for well constructed and circulated pools.

- Type of pool/spa filter: Any ANSI 50 approved filtration
- Type of pump: Enough to supply the minimum required turnover rate
- Voltage of power supply: 120 or 240V AC. See the specification label on inside of door.
- Maximum distance from injection point: Air tubing length should be as short as possible with no more than 15 feet from the system to the venturi injector.
- The system is NEMA 3R Rated. It is recommended to install away from upward facing sprinklers.
- The maximum operating water pressure shall not exceed 50 psi
- Water quality at installation:
The water quality should be in normal ranges prior to installing the Clear Comfort system.

CLEAR COMFORT SUPPLIED MATERIALS

Components supplied for the Clear Comfort system:

1. Clear Comfort system.
2. Power cord: 10 feet.
3. Venturi injector.
4. 15 ft. of ¼-inch air tubing.
5. Check valve.

RECOMMENDED MATERIALS AND TOOLS

1. Power drill.
2. Bolts/screws/brackets/hangers for mounting the Clear Comfort system.
 - May need special bracket to attach to an I-beam or pole.
3. Proper plumbing materials for venturi injector installation.

INSTALLING THE CLEAR COMFORT SYSTEM

Position the Clear Comfort system near the power supply. It is required the system be wired directly to the pump circuit or into wall outlet. The Clear Comfort system should never operate if the pump is not on or if water is not circulating. Select a location that minimizes the distance of the Clear Comfort system to the venturi injector - less than 15 feet is required.

SYSTEM INSTALLATION - LOCATION

1. Determine the best location and mount the Clear Comfort system.
2. Using four screws, or appropriate hardware with wall anchors to mount the Clear Comfort system, mount the system to the wall with proper hardware to the Clear Comfort enclosure.
3. Mount the system at or above water level of pool or spa whenever possible.
4. The unit must be installed within 15 feet from the venturi injection site.

SYSTEM INSTALLATION - ELECTRICAL

1. The device must be properly connected to the correct power source (either 60Hz 120Vac or 240Vac) using the supplied power cord in accordance with the local electrical code.
2. Direct Pump Circuit Connection:
The unit can be hardwired to the pump circuit and controlled by the pump circuit. (Rather than hardwiring, an appropriate 120Vac or 240Vac receptacle outlet and plug may be used to connect to the pump controlled circuit.)
3. Outlet Installation:
If the unit is being wired to standalone AC power (i.e., not through the pump circuit on either 120Vac or 240Vac) it should be installed and plugged in through a Ground Fault Circuit Interrupt (GFCI). Regardless if hardwired or standalone connected, the electrical connection must be made in accordance with the local electrical code.
4. 240 Volt power supply cord supplied and must be field wired in accordance to the National Electrical Code and in accordance with local regulations.
5. Test for proper grounding and secure connections.

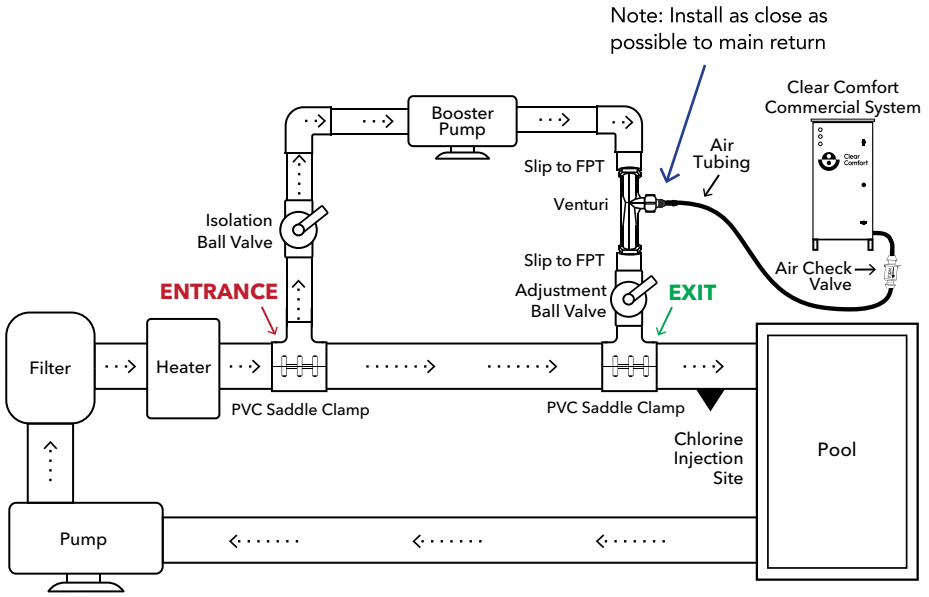

Figure 1:
Full System Diagram With Booster Pump

NOTE: *Not to Scale

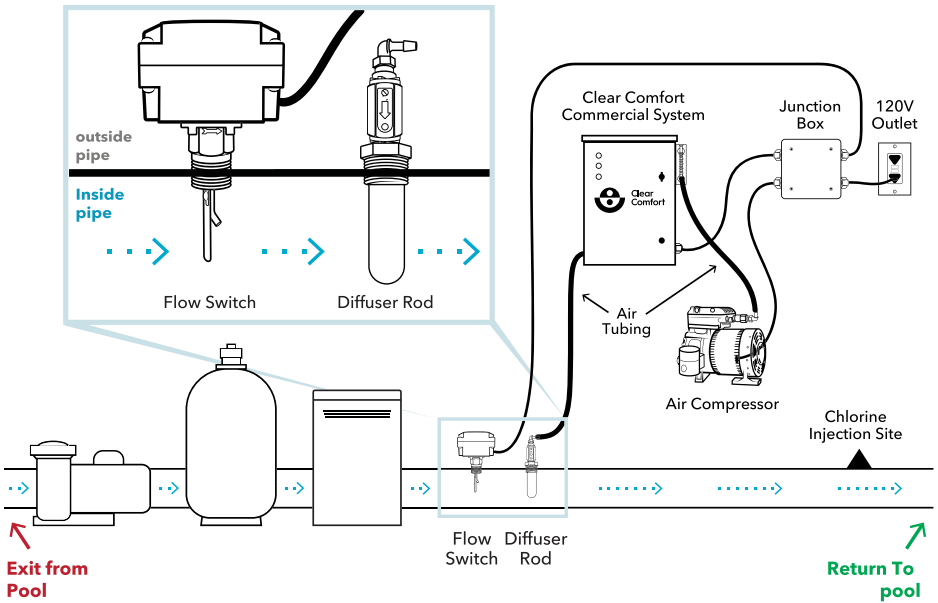

Figure 2:
Full System Diagram With Inline Diffuser Installation Kit

NOTE: *Not to Scale

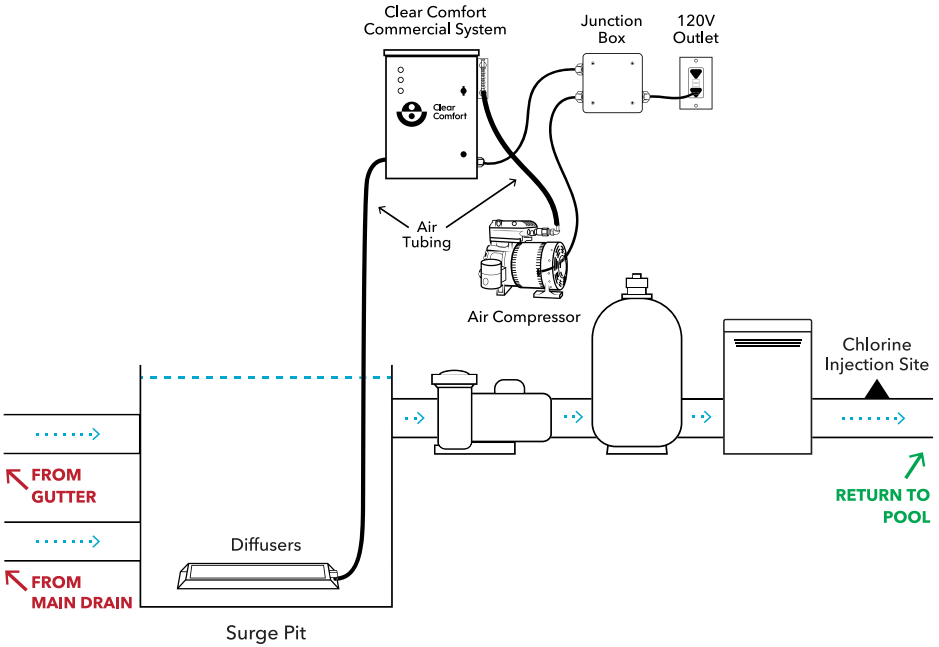

Figure 3:
Full System Diagram With Surge Pit Diffuser Installation Kit

NOTE: *Not to Scale

SYSTEM INSTALLATION - CONNECTING SYSTEM AND VENTURI LOOP

1. Turn main pool pump OFF and switch OFF the main pool circuit breaker.
2. Close water main valves before and after injection site to isolate water from pool (if applicable).
3. Locate section of existing plumbing in which you choose to install the ENTRANCE leg connecting the main line of flow to the venturi bypass pump. See Figure 1 on previous page - please note: entrance leg may be positioned after the heater.
4. Locate section of existing plumbing in which you choose to install the EXIT leg from the venturi bypass. Location should be in any accessible area after the filter and heater (if equipped) on the main line as water is returning to the pool, and BEFORE the chlorine/ bromine injection site. See Figure 1 on previous page for location.
5. Venturi injector MUST be positioned as close as possible to the main line at the end of the exit leg to allow maximum water contact with hydroxyls.
6. EXIT leg should be as far upstream as possible from chlorine injection location in main line.
7. Connect ENTRANCE leg to the suction side of bypass booster pump. The bypass booster pump shall be secured in a dry and protected area free of water. Placement on floor is recommended.
8. Connect pressure side of bypass booster pump to 1.5" venturi (provided).
9. MAKE CERTAIN THE VENTURI IS INSTALLED WITH THE FLOW MARK IN THE PROPER DIRECTION. IF REVERSED IT WILL NOT OPERATE.
10. Connect venturi to EXIT leg of bypass returning flow to main pool return line.

- Run the desired length of ¼" silicone tubing from the venturi injection port to the straight barb fitting within the Clear Comfort system. Distance should be no longer than 15 feet. See Figure 2 below.

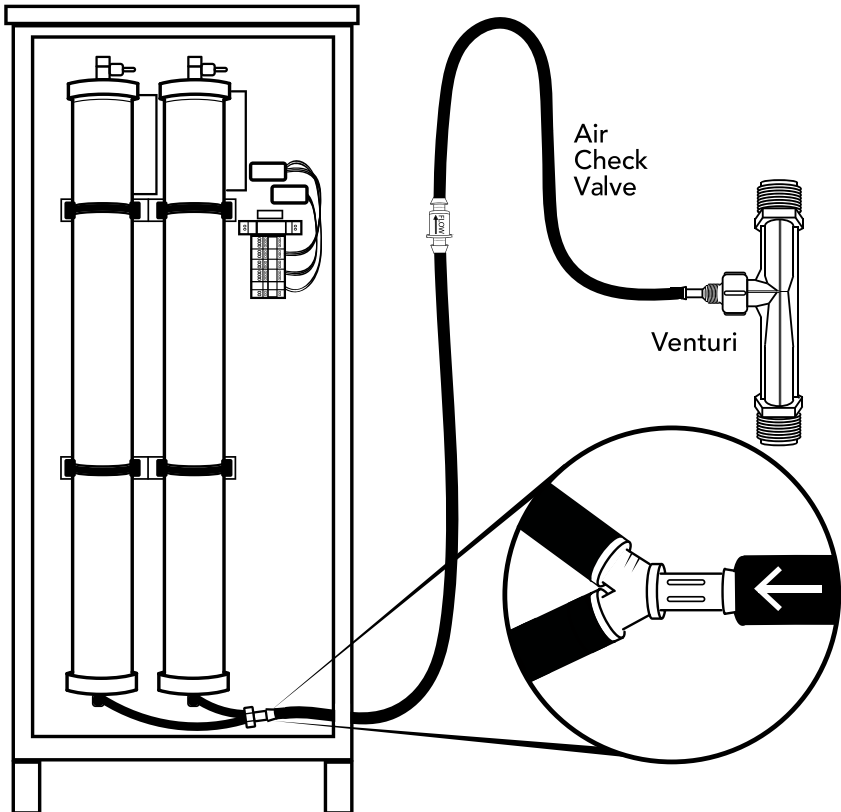

Figure 4: Venturi Connection

11. Install 1/4" one-way check valve (supplied) in-between the Clear Comfort system to eliminate any potential water back flow. Check valve should be oriented in a vertical orientation. See Figure 3 for details.

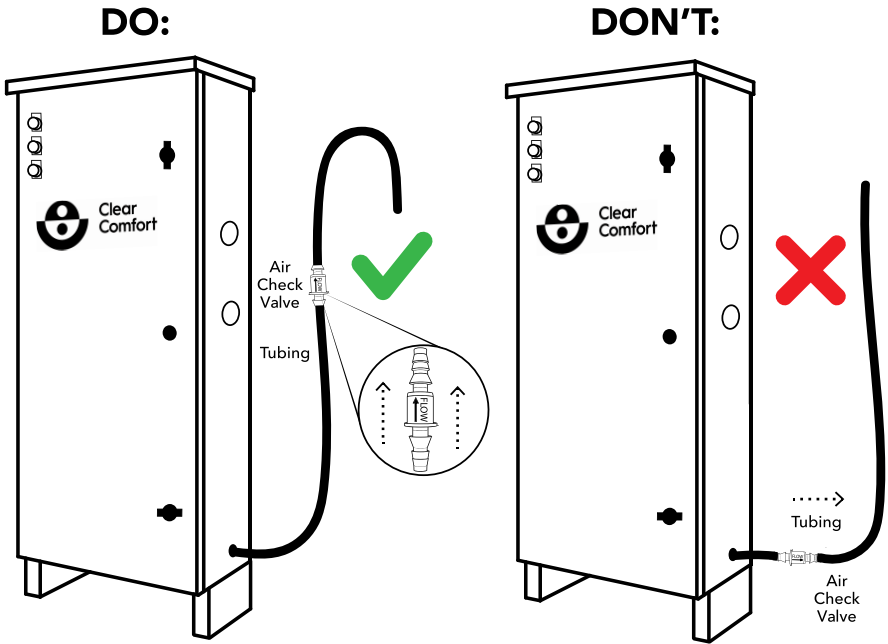

Figure 5: Air Check Valve Position

12. Inspect 1/4" line to ensure that there are no kinks, bends. Gas exiting the Clear Comfort system to the venturi connector port should flow easily.

OPERATING INSTRUCTIONS

1. Adjust pool pH, Cyanuric Acid, Alkalinity, Calcium Hardness to correct operating levels.

pH	7.2 - 7.4
Cyanuric Acid	<50 ppm
Alkalinity	80 - 120 ppm
Calcium Hardness	100 - 300 ppm

2. Open valve isolating the venturi injection site from main pool water (if applicable)
3. Turn pool/spa pump and filtration systems on. Ensure proper function and note/fix any leaks that may have occurred during venturi installation.
4. Turn ON bypass booster pump.
5. Using an airflow meter, ensure air suction is in the following ranges:

Model	Unit	Minimum	Maximum	Booster Pump Size
CCW300A Entry Commercial	Standard Cubic Feet Per Hour (SCFH)	25 SCFH	30 SCFH	1 HP
	Liters Per Minute (LPM)	12 LPM	14 LPM	
CCW300 Medium Commercial	Standard Cubic Feet Per Hour (SCFH)	50 SCFH	60 SCFH	2 HP
	Liters Per Minute (LPM)	23 LPM	28 LPM	
CCW500 Large Commercial	Standard Cubic Feet Per Hour (SCFH)	110 SCFH	130 SCFH	3 HP
	Liters Per Minute (LPM)	55 LPM	62 LPM	

6. Close the front door of the Clear Comfort system, turn latch lock to the closed position, and toggle red power button to the ON position. LED will illuminate.
7. The blue LEDs will also illuminate indicating that each cartridge is operating properly.
8. At this point, the Clear Comfort system should be functioning, and thus applying treated air to the recirculating water via the venturi injector.
9. Check for bubbles in pool return jets — the water entering the pool/spa will inject thousands of entrained bubbles.

AIR FLOW METER

1. Disconnect the blue hose below the check valve. See Figure 7 below.
2. Connect blue hose to the connection of the flow meter.
3. Adjust the isolation ball valve or adjust RPM if VFD or variable speed pump is used to increase/decrease water flow until the correct rate of air suction is achieved on the flow meter. See chart on previous page.
4. When adjusted to the correct flow, disconnect blue hose and reattach to the check valve. Flow meter should never be permanently installed. Store flow meter within Clear Comfort enclosure.

From Clear Comfort System

To Venturi

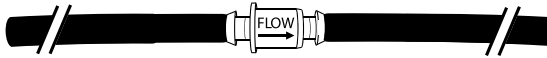

From Clear Comfort System

To Venturi

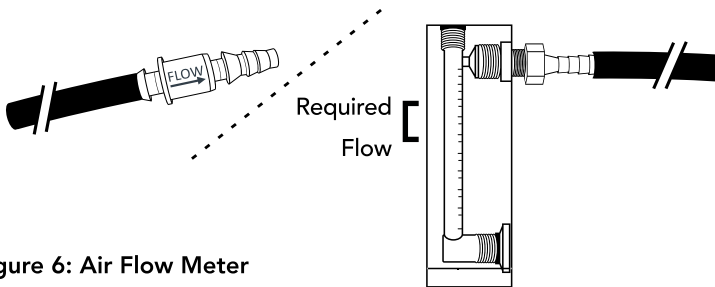

Figure 6: Air Flow Meter

SYSTEM MAINTENANCE

CARTRIDGE REPLACEMENT

The Cartridge must be replaced annually. No other maintenance is required. **CARTRIDGE REPLACEMENT SHOULD BE DONE THROUGH CLEAR COMFORT PERSONNEL OR THROUGH A POOL SERVICE COMPANY TRAINED BY CLEAR COMFORT. Never attempt to service unit while it is wet.**

1. Turn OFF power to Clear Comfort system by toggling red power button to the OFF position.
2. Turn OFF and disconnect power to Clear Comfort system from power source.
3. Disconnect ¼" blue tubing connections to cartridges.
4. Disconnect yellow electrical power connections.

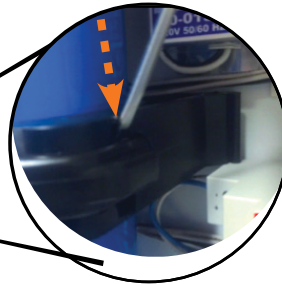
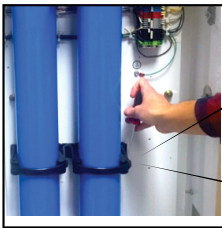
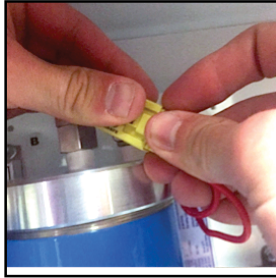

5. Using a small flathead screwdriver, carefully release all black brackets arms.
6. Firmly remove cartridge from black bracket housing.
7. Replace old cartridges with new cartridges. Ensure each cartridge is properly seated in both black brackets.
8. Secure both black cartridge bracket arms – it should easily click when secure.
9. Reconnect blue tubing to each cartridge, ensuring proper and secure fitting.



10. Using an airflow meter, adjust ball valve to properly size airflow through the venturi for the following ranges in the OPERATING INSTRUCTIONS section of this manual.
11. Close the front door of the Clear Comfort system, turn latch lock to the closed position, and toggle red power button to the ON position. LED will illuminate.

BACKWASHING INSTRUCTIONS

1. Turn OFF power to Clear Comfort system by toggling red power button to the OFF position.
2. Turn OFF power to bypass booster pump.
3. Close bypass ball valves isolating the bypass booster pump and venturi injector.
4. Properly backwash pool filters.
5. Once backwash is complete, open bypass ball valves.
6. Turn ON power to booster pump.
7. Using an airflow meter, adjust ball valve to properly size airflow through the venturi for the following ranges in the OPERATING INSTRUCTIONS section of this manual.
8. Close the front door of the Clear Comfort system, turn latch lock to the closed position, and toggle red power button to the ON position. LED will illuminate.

WIRING DIAGRAM

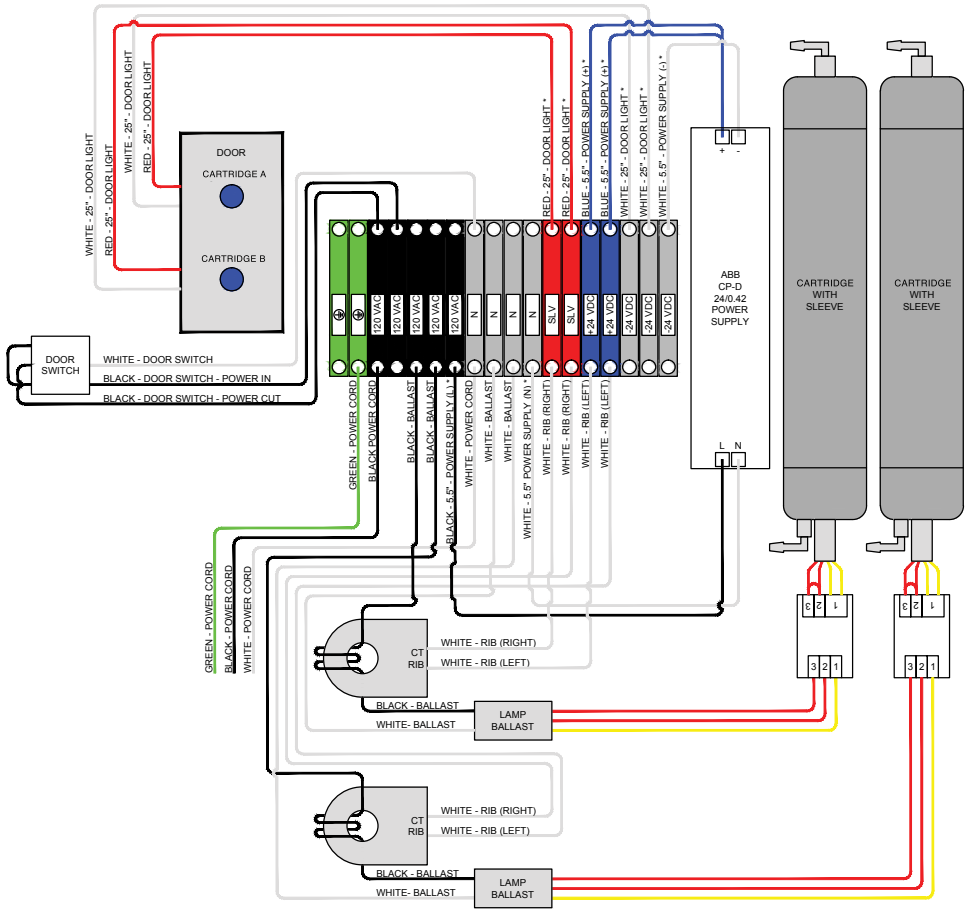

* WIRE TO BE CUT FROM SPOOL

This electrical connection must be made in accordance with the local electrical code.

WIRING INTO PUMP ELECTRICAL CIRCUIT

(Preferred Method)

The device must be properly connected to the correct power source (either 60Hz, 120Vac or 240Vac) using the supplied power cord in accordance with the local electrical code. The unit should be hardwired to the pump circuit and controlled by the pump circuit.

WIRING TO A STANDALONE ELECTRICAL OUTLET

(Use when pump continuously operates)

If the unit is being wired to standalone AC power (i.e., not through the pump circuit on either 120Vac or 240Vac) it should be installed to operate only when the pump is operating with its own timer circuit and plugged in through a Ground Fault Circuit Interrupt (GFCI) and the timer should be set to reflect the pool pumps hours of operation. The unit should not run when the pump is off. For questions regarding this operational mode please contact Clear Comfort at 303.872.4477.

240 Volt power supply cord supplied and must be field wired in accordance to the NEC (ONLY FOR 240V).

APPENDIX

HEAD LOSS (WITHOUT BOOSTER PUMP)

Flow (gpm)	7.80	14.57	21.81	29.17
Head Loss (psi)	0.57	5.92	17.96	34.83

(OPTIONAL) OXYGEN CONCENTRATOR INSTALLATION

O₂ Concentrators are not required or recommended by Clear Comfort, if you choose to install please contact the manufacturer.



We're here to help

Have questions? For assistance, contact us:

☎ 303.872.4477

✉ support@clearcomfort.com

🌐 clearcomfort.com/help

For the latest manual
version, scan the QR code or visit:
clearcomfort.com/commercial-manual

