



LANDSCAPE™

www.cast-lighting.com

Old world craftsmanship. . .tomorrow's technology®

CAST Landscape Lighting Training Manual

The Professional's Guide to Landscape Lighting : by David Beausoleil



LANDSCAPE™

Old world craftsmanship... tomorrow's technology®

Dear Landscape Professional,

When this manual was first published nearly 11 years ago, the landscape lighting profession was still young. Hundreds of green industry professionals were designing and installing systems for the first time. Since then, the industry has matured.

CAST Lighting wishes to thank all the designers, contractors and architects whose valuable knowledge and experience made the creation of this manual possible. Our company was created in response to these professionals who demanded fixtures and systems that matched the quality of their service. We are extremely grateful to these people and are proud to support them.

The objective of this manual is to build a solid foundation for the Landscape Lighting professional. With the knowledge and skills presented here, the professional can move forward with the confidence that every lighting project will be well designed and have superior system integrity.

This manual presents the fundamental design principals that are at the heart of every lighting system. It illustrates the lighting techniques that allow the designer to apply these principles, and it gives a step by step walk-through of every stage of installation. In addition, the important stage of documenting the job is covered in detail. Also presented are valuable marketing and sales guidelines that are drawn from the combined experience of dozens of successful Landscape Lighting installers.

CAST Lighting created this manual because we are committed to those dedicated professionals who truly care about the quality of their work, and who are willing to install professional quality fixtures and systems.

Once again, we thank you for your interest and encourage you to contact us with any questions or comments.

Yours Truly,

A handwritten signature in black ink, appearing to read "D. Beausoleil".

David Beausoleil
President, CAST Lighting LLC.

CAST LANDSCAPE LIGHTING TRAINING MANUAL

The Professional's Guide to Low Voltage Landscape Lighting

Contents

- Objectives2
- Design 2-3
- Techniques 4–11
- Planning 12–13
- Fixture Installation and Wiring 14–15
- Spider Splice Connections 16
- Transformer Stand 17
- Voltage Adjustment 18–22
- Documentation 23–24
- Technical Information 25
- Marketing and Sales 26–27
- Appendix 1 – Sample Proposal 28–31
- Appendix 2 – Sample Maintenance Agreement 32–33
- Appendix 3 – Preliminary Systems Requirements Worksheet 34
- Appendix 4 – Transformer and Wire Sizing Worksheet 35
- Appendix 5 – Field Voltage Adjustment Worksheet 36
- Appendix 6 – Transformer Lid Form and Installation Record 37
- Appendix 7 – Rough Sketch Design Sheet 38–39
- Safety Notes and Warranty 40

Contents of the Manual

Creating a Landscape Lighting design is similar to the process of creating any kind of Landscape design. There are objectives in mind, techniques to achieve those objectives, and tools to perform the techniques. The following manual presents all the basic skills and knowledge required for Landscape Lighting:

1. **Objectives.** Benefits for the client that can be realized with Landscape Lighting.
2. **Design.** Basic principals of visual qualities that define good Landscape Lighting.
3. **Techniques.** An illustrated approach to the techniques of lighting, fixture selection and how they are used in different scenarios.
4. **Planning.** Simple worksheets and formulas to correctly select wire and transformers.
5. **Fixture Installation and Wiring.** Simple steps for system installation.
6. **Spider Splice Connections.** Instructions for the use of this preferred CAST method of wire connections.
7. **Transformer Stand.** Assembly instructions for transformer mounts.
8. **Voltage Adjustment.** Steps for using CAST's proven method of field testing and adjustments for delivering the right voltage.
10. **Technical Information.** Electrical formulas and lamp information.
11. **Marketing and Sales.** Proven methods for growing your business.
12. **Appendix.** Useful worksheets, sample proposal and maintenance contract.

Advisory and Disclaimer: Before undertaking the installation, servicing, or maintenance of a low-voltage lighting system, contractors should obey any applicable codes, guidelines, and restrictions that may apply in their regions. CAST Lighting is not liable for any consequence that may arise from the use of material in this manual.

Visit www.cast-lighting.com

© Copyright 2018, David Beausoleil. All rights reserved.

LIGHTING OBJECTIVES

Security

Security from theft and trespassing is a primary concern for all homeowners and is usually addressed with high voltage floodlights. A better choice is strategically placed low voltage lights that provide low levels of illumination strategically distributed around the property. This avoids the problem of glaring lights and unlit regions that allow intruders to remain unseen.

Safety

Low voltage lighting is an ideal choice for illuminating walkways and entrance ways. This ensures that residents and visitors can safely navigate through the property avoiding otherwise unseen obstacles.

Usability

Illuminating the public and private areas of a property allow the homeowner to enjoy decks, sitting areas and recreational spaces.

Beauty

Light defines textures, shapes and structures while evoking a wide range of positive emotional responses. A good lighting design can create moods that are soft and subtle or dynamic and dramatic. It can highlight features of the structure and property, while maintaining a cohesive scene. Good Landscape Lighting is a feast for the eyes.

The Power of Light

Nothing has a greater effect on the comfort of an individual than the quality of light. Think about how you feel when approaching a dark house compared to how you feel when entering the property of a beautifully illuminated home.

The lighting designer recognizes this and creates a scene where the viewer is an active participant. This scene presents a cohesive panorama framed by the borders of the property. Lighting displays the beauty of the landscape and highlights the architectural features of the building.

The Public Space (Front Yard)

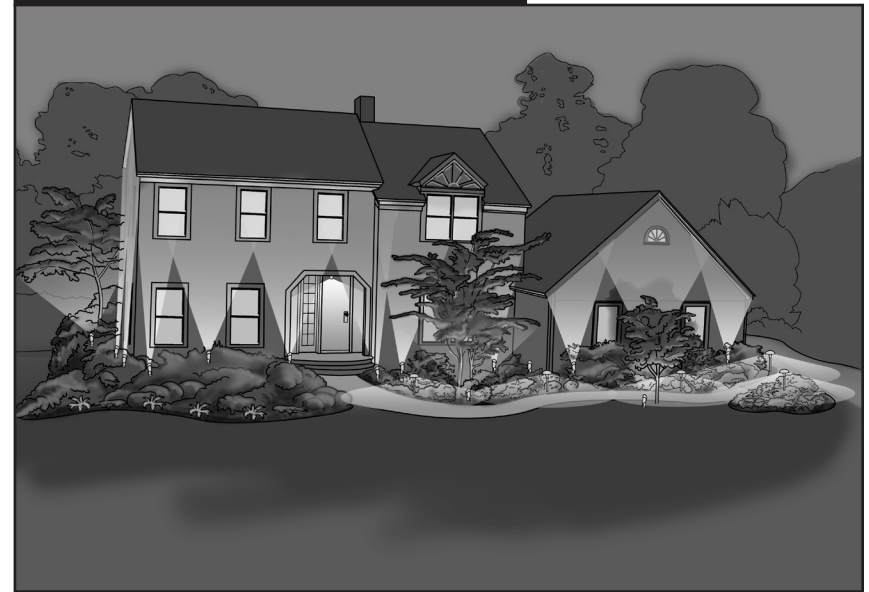

Fig. 1. A typical lighting design for the public space. This illustration shows how the careful choice and placement of fixtures creates a scene that is both welcoming and dramatic.

Cohesion

Cohesion refers to the overall appearance of the scene as one continuous panorama. If there are unlit areas near illuminated ones, then the viewer's visual experience is interrupted. These "black holes" detract from the beauty of the design and fatigue the eyes.

Cohesion is achieved by illuminating borders, backgrounds, and intermediate areas with the creative use of fixtures placed for that purpose.

Depth

Depth refers to the strategic placement of fixtures using different light levels to achieve a three-dimensional scene. Depth requires lighting areas that are in the foreground, in the middle, and in the back of the scene.

The proper use of high, medium, or low wattage lamps (with varying beam spreads) helps establish depth by allowing the designer to create scenes that draw the eye from near to far.

Focal Points

Keep in mind that the designer is not only painting a picture with lights, he or she is also directing a scene.

In this scene, the viewer's eyes are first drawn to one focal point then to another and so on. These focal points may be unique features of the property such as, statuary or water features; or they may be functional points such as entrance ways, sitting areas or gathering places.

The Private Space (Back Yard)

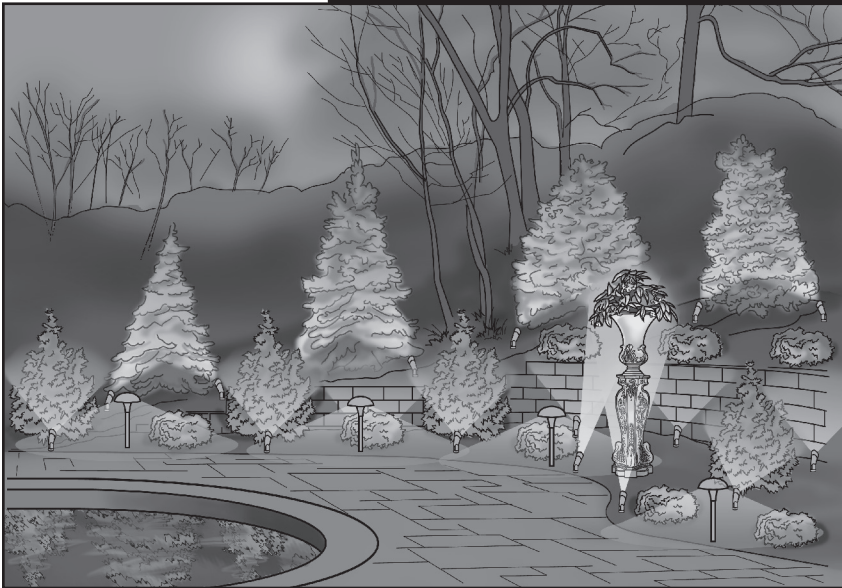

Fig. 2. **A typical lighting design for the private space.** This illustration shows how good design can increase nighttime usability of recreational areas in the owner's backyard.

Quality and Direction

Low voltage fixtures provide illumination that is highly controllable. Instead of the harsh glare of bare bulbs, light is directed to the desired places. In a good lighting design, light sources are not seen, only the reflection of their light off a variety of surfaces.

The quality of lighting is changed by uplighting (more dramatic), downlighting (more natural), sidelighting (emphasizes details), or backlighting (emphasizes form).

Perspective

Perspective refers to the viewer's experience from various locations both outside and inside the home. The designer needs to walk the property and ensure that the lighting scene works from all possible vantage points (including from the approaching road).

Inside the home, the viewer should be able to look out the windows and enjoy the scene without being blinded from fixtures illuminating the house.

Balance and Symmetry

A lighting designer needs to recognize the features of a landscape that define its appearance. If there are repeating patterns such as a row of bushes, fencing or stone walls, then the designer needs to light those forms in a way to preserve that symmetry.

The designer also needs to balance the lighting so that one side of the property is not brighter than the other.

A Relaxing Outdoor Environment is achieved by:

- ▶ *Smooth transitions*
- ▶ *Varied light levels that direct the eye naturally from one area to another and create depth*
- ▶ *Balanced lighting across the scene*
- ▶ *Focal points*
- ▶ *Visual Direction*

DESIGN STEPS

Set Objectives

Step 1

You and the client discuss what can be reasonably achieved with a lighting system within the constraints of the budget. Write down all the intended objectives.

Walk the Property

Step 2

Walk the property, viewing from every angle (including from the approaching road.) First, think about the visual composition of the entire scene. Note what is beautiful and distinctive about the property. Recognize features of the landscape and structures and note repeating patterns and interesting forms.

Next, determine focal points and decide where you want the viewer's attention to be directed. Pay attention to transition areas and apply the basic elements of design to create a scene that satisfies your objectives.

Flag the Job

Step 3

As you decide on the location of each fixture, place a colored flag at the spot. Use a different color for each fixture type and write lamp wattage and beam spread on each flag.

Rough Sketch

Step 4

Make a rough sketch of the property, labeling each of the important areas and features. Indicate the placement of fixtures and transformers. Measure or estimate the distance of each wire run. Check for availability of 120V power supply.

Using the worksheets in this manual, calculate wire sizes and transformer requirements, then create a materials list.

UP LIGHTING

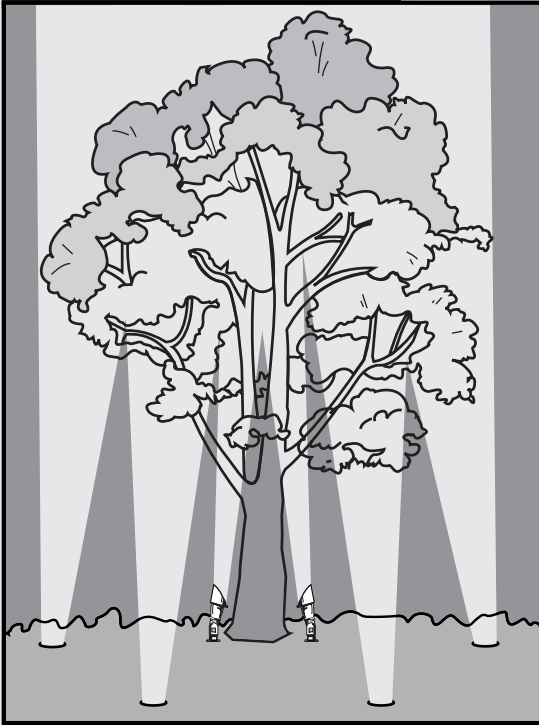

Purpose

To highlight trees, other plant materials or architectural features; tends to be more dramatic than down-lighting, but can also look natural when applied with skill.

Fixtures Used

Directional lights, well lights

Considerations

For pine trees and other dense foliage plant material, place fixtures outside the drip line of the plant and limit spacing to 5 foot on center. Less dense trees usually require far fewer fixtures with 8 to 10 foot spacing. For tree trunks, use low intensity grazing technique to accentuate textures.

MOON LIGHTING

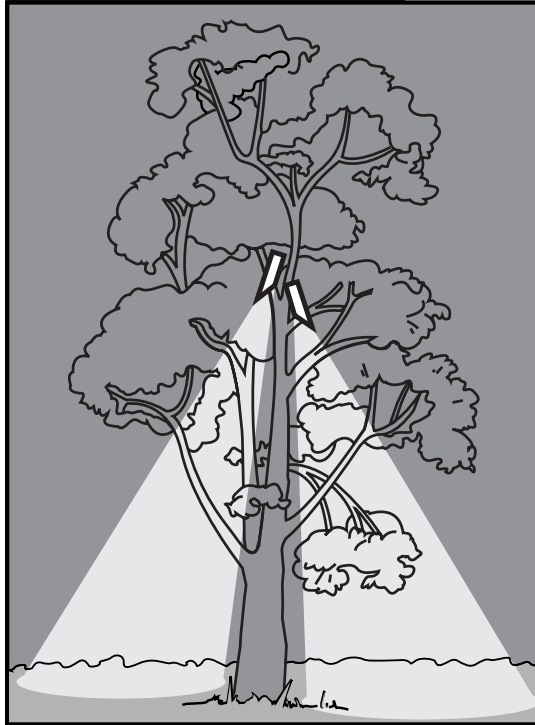

Purpose

To provide soft natural lighting over large areas, serves as an ideal transition connecting different lighting scenes together and eliminating black holes from the project.

Fixtures Used

Tree lights

Considerations

Fixtures must be at least 25 ft. high (aimed minimum 45% from horizontal). At least two lights per tree is recommended. Fasten fixtures to tree with mounting canopy. Do not screw canopy directly to tree surface, allow space behind canopy to prevent tree rot.

CROSS LIGHTING

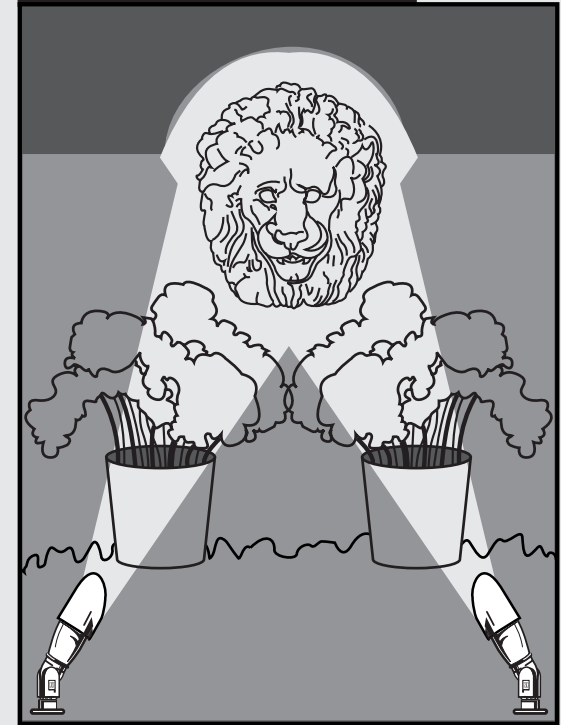

Purpose

Defines surface texture and shape instead of flattening effect when using a single front light.

Fixtures Used

Directional lights, well lights

Considerations

Often used to define focal points. Lamp selection and fixture placement is critical. Lights can be mounted above or below subject. When two lights are used, use lower wattage lamp on one side for a more natural effect.

MIRROR LIGHTING

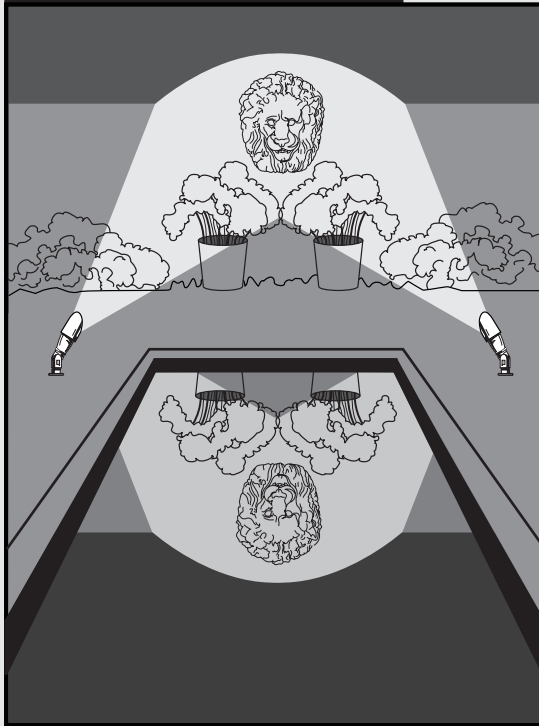

Purpose

To take advantage of the reflective surface of water features to create a more compelling visual experience.

Fixtures Used

Directional lights, well lights

Considerations

Consider the visual experience from all likely viewing angles. Add illumination to various regions of the background to contribute to the overall impact. Check that bare lamps do not reflect off the water into the viewers' eyes.

WALL LIGHTING

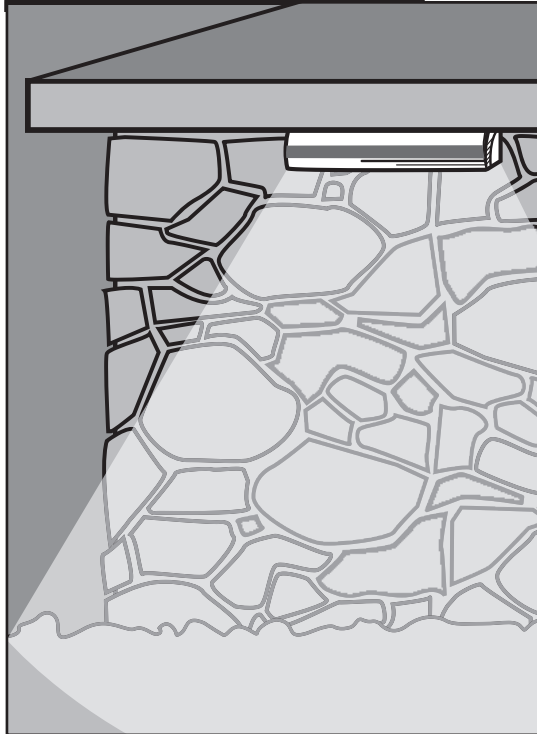

Purpose

To illuminate retaining and free-standing walls and regions adjacent to them.

Fixtures Used

Engineered Wall Lights

Considerations

Engineered wall lights are affixed with a bracket extending from the back of the fixture body. This bracket slips under the capstone or between blocks. Fixtures should be spaced equidistant from each other.

STEP LIGHTING



Purpose

To illuminate steps

Fixtures Used

Deck lights, Path Lights

Considerations

Steps should receive fairly uniform illumination to prevent tripping hazards. Lights may be positioned on one side or both depending on the width of the stairs and the fixture mounting height.

PATH/AREA LIGHTING

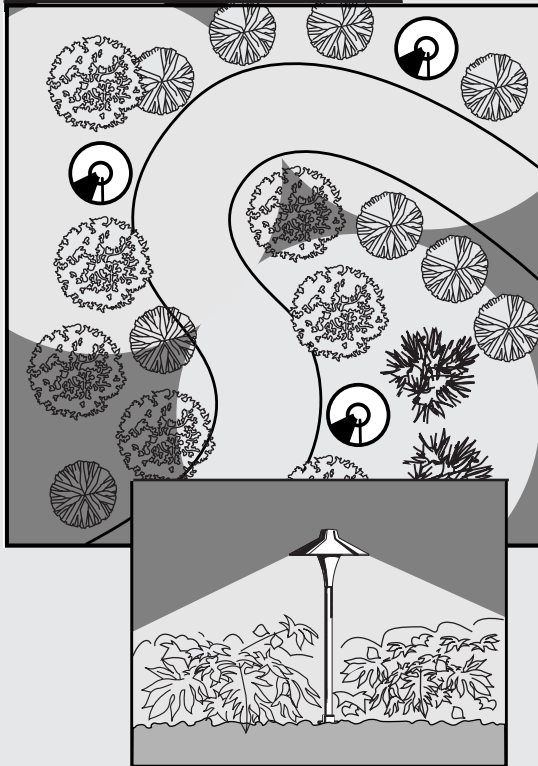

Purpose

To light planting beds and paths. And, to provide seamless transition between lighting scenes.

Fixtures Used

Path Lights

Considerations

Space and position fixtures to provide a visually appealing illumination along the path. Alternate placement from one side of the path to the other. Provide enough illumination to prevent tripping hazards, but space fixtures far enough apart to create distinct pools of light.

GRAZING

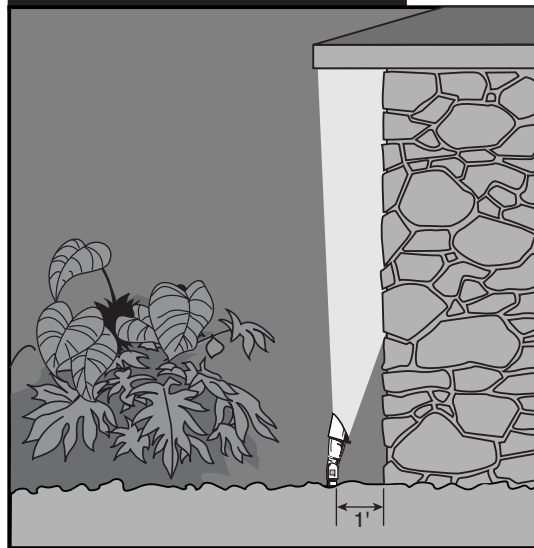

Purpose

To provide a steeply angled light to accentuate texture on walls and tree trunks by utilizing the irregular surface to create broken shadows and irregular patterns.

Fixtures Used

Directional Lights, Well Lights

Considerations

Position fixtures within 1 foot of walls or tree trunks. Tilt fixture away from wall to minimize hot spot and provide a more even light distribution from top to bottom.

SILHOUETTING



Purpose

To provide a lit surface that acts as a backdrop for unlit plant material or other features; the effect can be mysterious and compelling.

Fixtures Used

Directional Lights, Well Lights

Considerations

This technique produces dramatic effects and is best used for objects and features that have distinctive and interesting shapes.

WALL WASHING

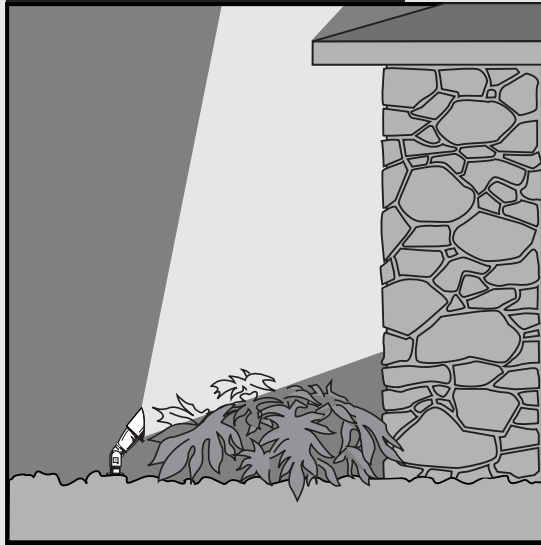

Purpose

To provide an even illumination on walls.

Fixtures Used

Directional Lights, Well Lights, Wall Wash Light

Considerations

Take care that these lights are not glaring for occupants inside the house.

Wall washing provides a broad, even illumination across a house or wall. The frontal angle produces a flattening effect (no shadows from the surface texture).

This technique can produce uninteresting lighting; visual interest can be improved by projecting the light through plant material.

BACKLIGHTING



Purpose

To provide illumination around the edges of an object, thereby emphasizing its shape, and creating a nighttime mood.

Fixtures Used

Directional Lights, Well Lights

Considerations

This technique is best used on objects with interesting shapes. Be sure that the fixture is hidden from view.

When two lights are used behind an object separated by a 120° angle, the effect is of light wrapping around the object. This technique works well with small conical shaped trees and large tree trunks.

SHADOWING

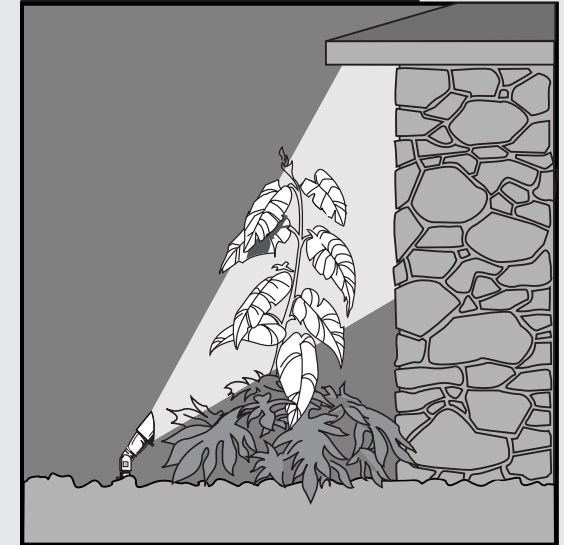

Purpose

To create interesting shadows on walls.

Fixtures Used

Directional Lights, Well Lights

Considerations

Shadows create visual interest on the structure. For houses with vinyl siding, use shadowing to break up the linear patterns.

When plant material is used to create shadows, the plants will need to be periodically trimmed, and fixtures may need to be relocated, to compensate for plant growth.

TECHNIQUES

OBJECTIVES: PUBLIC SPACE

- ▶ To create a welcoming feeling for family and guests
- ▶ To highlight the architectural features
- ▶ To visually lead visitors to the front entrance
- ▶ To provide safe passageway to the front entrance
- ▶ To highlight plant material
- ▶ To cast visually interesting shadows on the structure
- ▶ To create a cohesive scene with depth across the property

Left side is illuminated to define the structure, add depth and complete the scene. It also ensures that the structure looks good from side viewing perspectives. ①

Tree is illuminated to add detail, texture and depth to the scene. ②

Reflected light projects off the light colored surface of the structure and reflects out to the planting beds and walkway areas. This provides a low level fill lighting for the foreground of the scene. ③



Fig.3. Typical lighting design for the public space of a property with notes on lighting treatments and design.

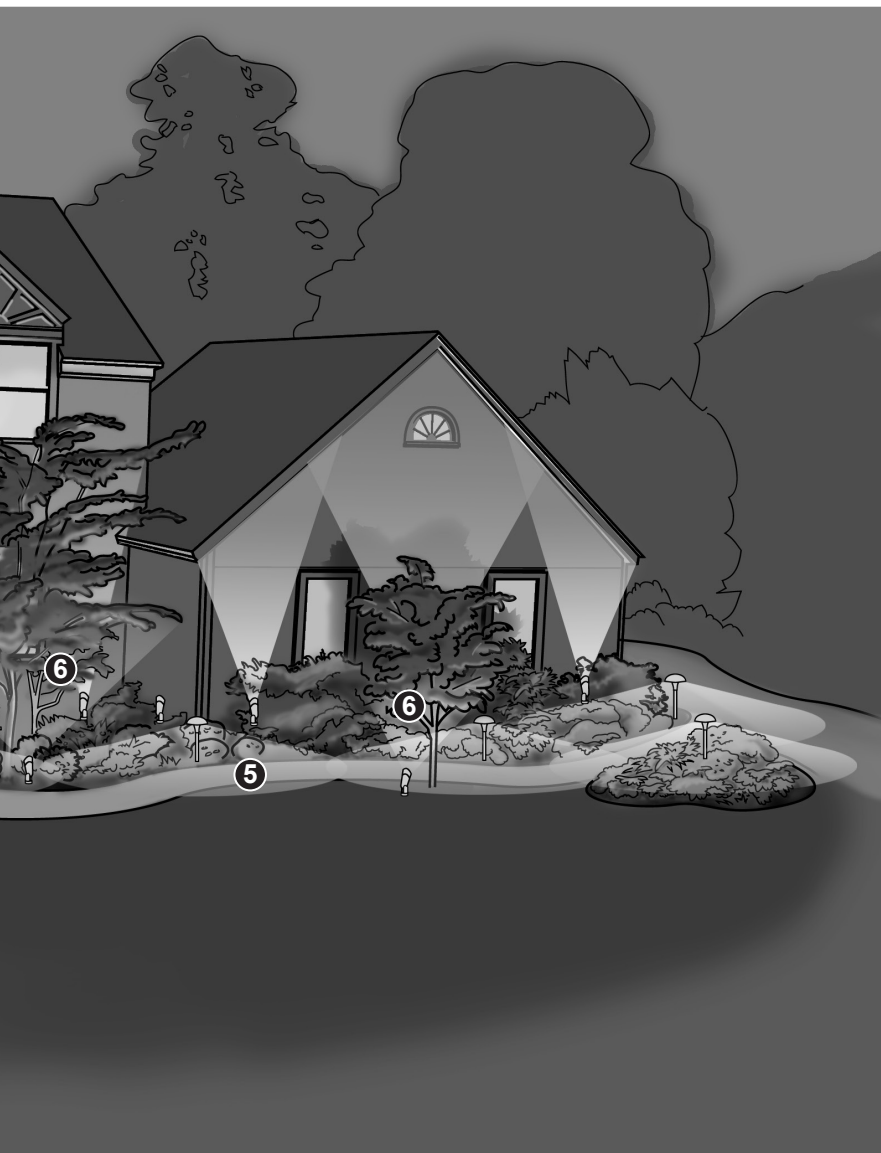

4 The entire house is selectively illuminated. This defines the structure. Lights are placed at the corners and between the windows, grazing the facade of the house.

5 Area/Path Lights provide clear direction to the front door as well as providing pools of illumination to reveal regions adjacent to the path.

6 Trees are uplit to project shadows on the front facade of the house and provide depth and detail to the foreground.

7 Entrance area. The light level of the entrance is the brightest part of the scene. This will direct guests to the front door.

OBJECTIVES: PRIVATE SPACE

- ▶ To create usable evening spaces for recreation
- ▶ To highlight the landscaping features
- ▶ To draw attention to the vase and pedestal
- ▶ To highlight plant materials
- ▶ To raise the ceiling of the visual space

The illumination of objects in the foreground and background creates visual depth. The illumination of objects from right to left creates a continuous and cohesive visual path.

①

Area/Path Lights are installed to illuminate the low ground cover and cast light onto the stone paver patio. This fill lighting in the foreground provides a compelling and safe foundation for the lighting scene. Designer uses CAST Small Mushroom Path Lights. Lights are spaced evenly apart.

②

The pool surface provides a perfect mirror to add depth and visual interest and to further enhance the scene. (Pool light should be off to maximize this effect.)

③

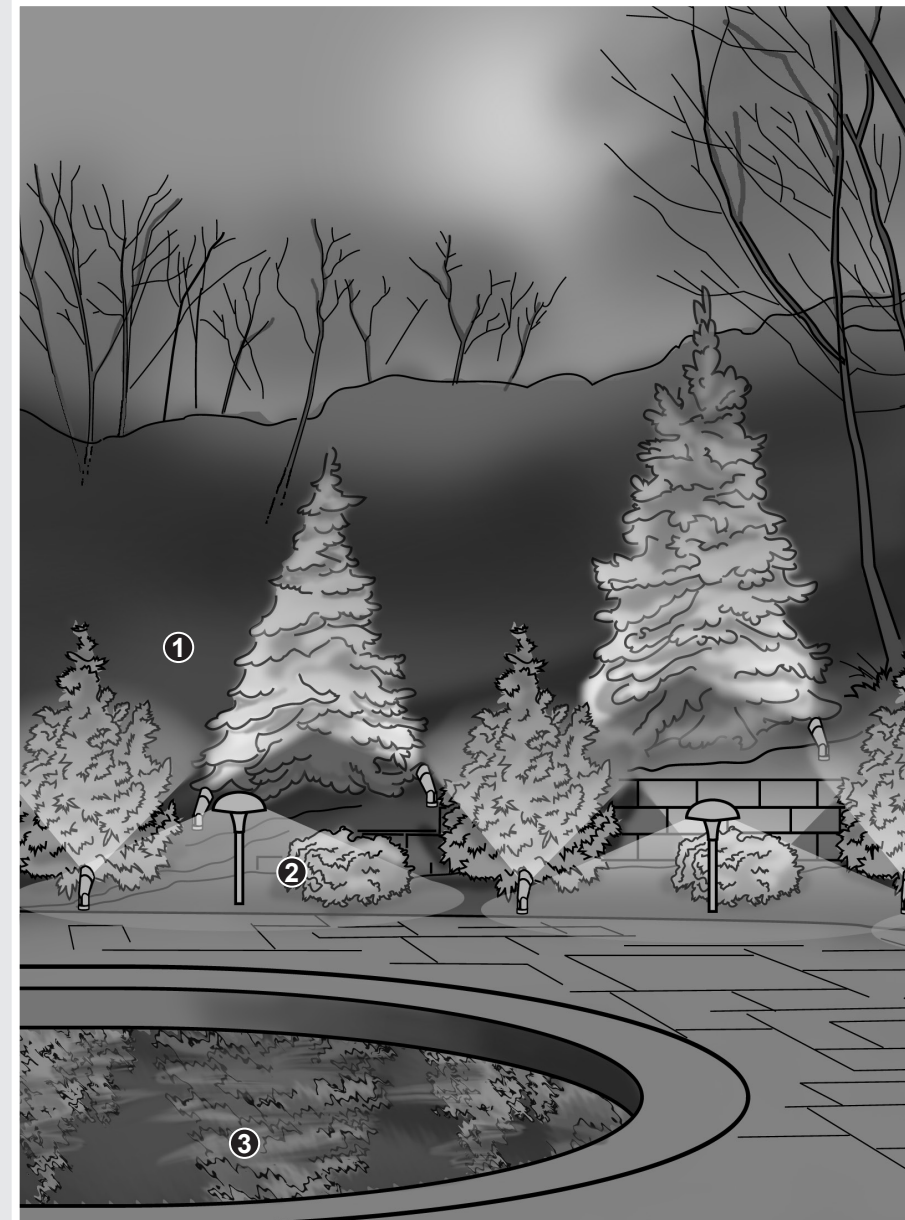

Fig.4. Typical lighting design for the private space of a property with notes on lighting treatments and design.

TECHNIQUES



4 Large trees in the far background could be uplit to raise the ceiling of the backyard thereby adding vertical scale to the visual composition.

5 Larger background plant material is illuminated to the highest level in order to draw the viewers eye through the lighting scene and create depth.

6 The vase and pedestal create a focal point in the scene. Illuminating this feature using the highest light level draws attention to it above all else. Crosslighting reveals the detail of the concrete's surface.

7 The stone wall is illuminated to a medium light level using a grazing technique. Fixtures are evenly spaced to maintain a balanced and symmetrical illumination.

8 Middle ground plant material is illuminated to a medium light level using an up lighting technique.

PLANNING STEPS

Step 1 Requirements

Working from the rough sketch, the contractor can use the “Preliminary System Requirements Worksheet” (Fig. 5) to record all the information needed to make the following calculations.

Step 2 Wire Sizing

Landscape Lighting requires either #10/2 or #12/2 direct burial wire to connect transformers to Spider Splices. The selection is based on wire run distances and wattage of fixtures on each run. This determination can be made using the “Quick Wire Sizing Guide” (Fig. 6).

Step 3 Transformer Sizing

Selecting the correct transformer(s) is a two-step process.

- Determine total load on the system. This can be estimated by adding the total wattage of all lamps. Or, the load can be more precisely calculated using the “Transformer and Wire Sizing Calculations” worksheet (Fig. 8.)
- Select the transformer(s) based on the total load using the “Quick Transformer Sizing Guide” (Fig. 7) If you are working with the total lamp wattage, compare that number with the “75% Lamp Load” column. If you calculate load using the longer worksheet then compare that value with the “Capacity” column. In both cases, select a transformer with a capacity exceeding these numbers to allow for future additions to the system.

The following worksheets and sketches on this and following pages depict a typical residential lighting installation from start to finish.

PRELIMINARY SYSTEM REQUIREMENTS WORKSHEET									
WIRE RUN	LOCATION	FIXTURE TYPE	QTY.	X	LAMP WATTAGE	=	TOTAL WATTAGE	DISTANCE FROM SPIDER SPLICE TO TRANSFORMER	
								#12-2 WIRE PER RUN	#10-2 WIRE PER RUN
1	Grove	Bullet	1	X	35w	=	35w	50'	
1	Grove	Small Mushroom	3	X	20w	=	60w		
2	Front Walkway	Small Mushroom	5	X	20w	=	100w	85'	
3	Side Garden	Bullet	4	X	35w	=	140w		120'
4	Side Walkway	Small Mushroom	5	X	20w	=	100w		29'
4	Side Walkway	Bullet	1	X	35w	=	35w		
5	Back Garden	Well Light	4	X	35w	=	140w		150'
6	Pond	Bullet	2	X	35w	=	70w		200'
6	Pond	Well Light	2	X	35w	=	70w		
TOTALS							750w	135'	499'

Fig.5. Preliminary System Requirements Worksheet — used to initially record planned system details. Blank worksheet for copying on page 34.

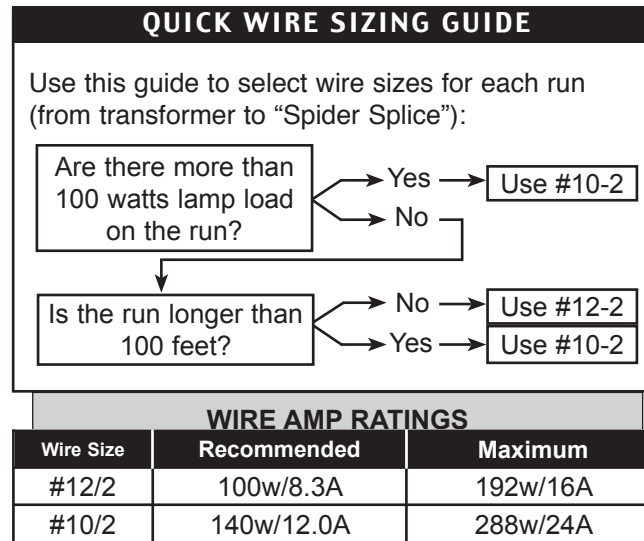

Fig.6. Quick Wire Sizing Guide. In this example wire run 1 and 2 require #12/2 while the others need #10/2.

QUICK TRANSFORMER SIZING GUIDE		
Model #	Capacity (Watts)	75% Lamp Load (watts)
CAST “Journeyman Series” (12-15v taps)		
CJ300PSMT, CJ300SSMT	300	225
CJ600PSMT, CJ600SSMT	600	450
CJ900PSMT, CJ900SSMT	900	675
CAST “Master Series” (12-18v taps)		
CM900SSMT	900	675
CM1200SSMT	1200	900
CM1500SSMT	1500	1125
CAST “Power Pro Series” (12-22v taps)		
CP900SSMT	900	675
CP1200SSMT	1200	900

Fig.7. Quick Transformer Sizing Guide. In this example the 1200 watt transformer is needed because the calculated 750 watt lamp load exceeds the capacity of the 900 watt transformer. It’s always a good idea to have a slightly larger transformer in case the job requires higher wattage lamps or extra fixtures.

TRANSFORMER AND WIRE SIZING CALCULATIONS FOR LANDSCAPE LIGHTING



Guidelines for selecting wire size to maximize the efficiency of a low voltage lighting system:

#12-2	Total combined lamp wattage of 100 watts or less. Total wire run of 100 ft. or less to the Spider Splice .
#10-2	Total combined lamp wattage of 140 watts or less. Total wire run in excess of 100 ft. to the Spider Splice .
#8-2	Very expensive wire—better to run two pieces of #10-2 wire than one #8-2 wire.

OPERATING VOLTAGE

Optimal voltage for lamps is between 10.8v and 11.3v.

WIRING AND LAMP INFO

RUN #	WIRING METHOD (SPIDER OR TEE)	WIRE SIZE	TOTAL LAMP WATTAGE ON THE WIRE RUN (See Example Below)
1	Spider	12-2	3@20w 1@35w =95w
2	Spider	12-2	5@20w =100w
3	Spider	10-2	4@35w =140w
4	Spider	10-2	5@20w 1@35w =135w
5	Spider	10-2	4@35w =140w
6	Spider	10-2	4@35w =140w
7			
8			
9			
10			

TO DETERMINE VOLTAGE TAPS REQUIRED

AMP LOAD (Lamp Wattage Divided by 12)	x	WIRE LENGTH (To Spider Splice or Tee Connection)	x	2	x	RESISTANCE PER FOOT (See Chart Below)	=	VOLTAGE DROP	+12	=	TAP NEEDED (Round to nearest whole number)
7.917	x	50'	x	2	x	.00162	=	1.28	+12	=	13
8.33	x	85'	x	2	x	.00162	=	2.29	+12	=	14
11.667	x	120'	x	2	x	.00108	=	3.02	+12	=	15
11.25	x	29'	x	2	x	.00108	=	0.70*	+12	=	12
11.667	x	150'	x	2	x	.00108	=	3.78	+12	=	16
11.66	x	200'	x	2	x	.00108	=	5.037	+12	=	17
	x		x	2	x		=		+12	=	
	x		x	2	x		=		+12	=	
	x		x	2	x		=		+12	=	
	x		x	2	x		=		+12	=	

TO FIND TRANSFORMER WATTAGE

AMP LOAD (From previous AMP LOAD column)	x	TAP NEEDED (From Previous TAP NEEDED Column)	=	TOTAL WATTS
7.917	x	13	=	102.92
8.33	x	14	=	116.62
11.667	x	15	=	175.00
11.25	x	12	=	135.00
11.667	x	16	=	186.67
11.667	x	17	=	198.83
	x		=	
	x		=	
	x		=	
	x		=	

GRAND TOTAL (Min. Transformer Wattage) 915.04

TRANSFER AMP LOAD VALUES FOR EACH RUN TO THIS COLUMN

TYPICAL EXAMPLE

1	Spider	#10/2	4@35w=140w	11.66 amps	x	150 ft.	x	2	x	.00108	=	3.77	+12	=	15.77	11.66	x	16	=	186.56			
				↑					↑					↑					↑				
				140 watts is divided by 12 volts = 11.66 amps					#10-2 Wire Resistance per ft. from chart below					Tap Required (Round up to 16 volts)					Actual Transformer Watts Required				

REFERENCE TABLES

RULE OF THUMB

Since wire loss can be as high as 20%, the lamp load should never exceed 80% of the transformer's rated wattage capacity.

WIRE AMP RATINGS

Wire Size	Recommended	Maximum
#12/2	100w/8.3A	192w/16A
#10/2	140w/12.0A	288w/24A

AWG RESISTANCE PER FOOT (According to Wire Size)

#18	.006385	#14	.002525	#10	.00108	#6	.000395
#16	.004016	#12	.00162	#8	.00064	#4	.000249

Formula for Voltage Drop is 2 x Length of Wire x Amps x Resistance per Foot

Fig.8. "Transformer and Wire Sizing Calculations". Blank form for copying can be found on p.35.

*No change is required; use 12 volt tap. Operating range of lamp is within acceptable range.

INSTALLATION and WIRING STEPS*

Step 1 Fixture Preparation

After unloading all materials, remove fixtures from boxes. Attach stakes and stems, if necessary. Lay each fixture at its proper location.

Step 2 Trenching

Low voltage lighting wire requires a minimum of 6 inches burial and can be run without conduits. Use slit trenching technique (use CAST trenching tool CWTT) to dig narrow trenches along each wire run and between fixtures and Spider Splices®. (See photos on this page.)

Step 3 Running Wire

Place correct wire size on spool or spinner (use CAST Wire Spinner CSPIN). Then, starting at the transformer, pull each wire run ending at the Spider Splice. Leave about 10 extra feet for each run at the transformer and 2 feet extra at the Spider Splice. Label each wire run with wire markers (CMPAD) at both ends. Run lead wire from each fixture to the Spider Splice leaving excess wire coiled and buried at the base of the fixture. For above-grade fixtures, leave excess wire coiled at the Spider Splice.

Step 4 Lamping Fixtures

Install the fixture into the ground or mount to the appropriate surface.

Lamp each fixture with the correct lamp according to type, wattage and beam spread. Leave the lamp box at the base of the fixture so you can refer to it when you punch the "Fixture Record Tag" at the end of installation. Leaving the box also facilitates changing the lamp if that becomes necessary during the final adjustment stage.

***Note: It is your responsibility to know and follow local, state and federal electrical regulations and codes that apply to low voltage lighting installation in your region.**

TYPICAL WIRE RUN

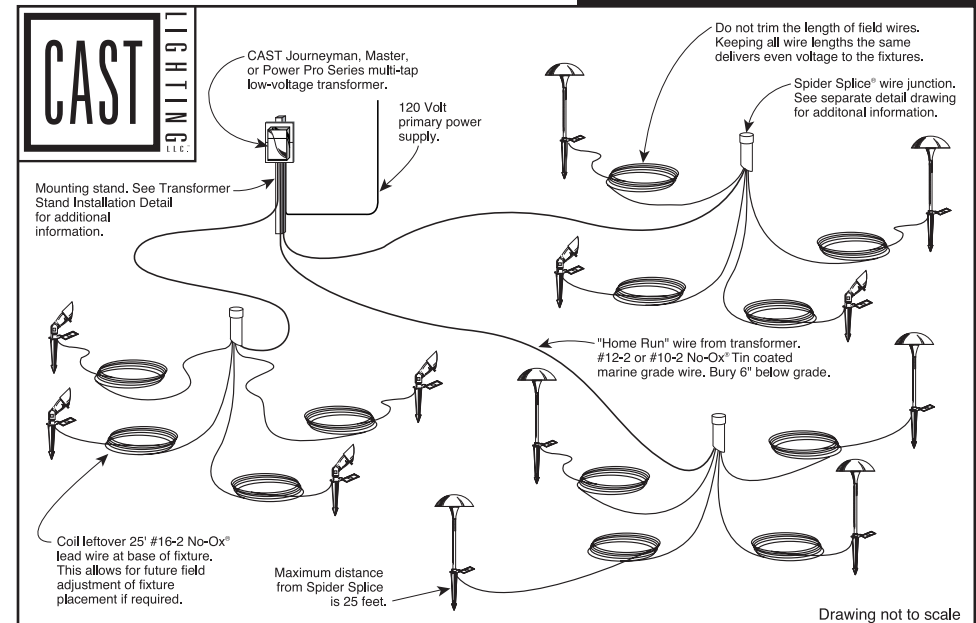

The CAST Trenching Tool (CWTT) cuts a narrow 8" deep trench ideal for laying wire.



Pushing the tool back and forth widens the trench and creates a channel for the wire.

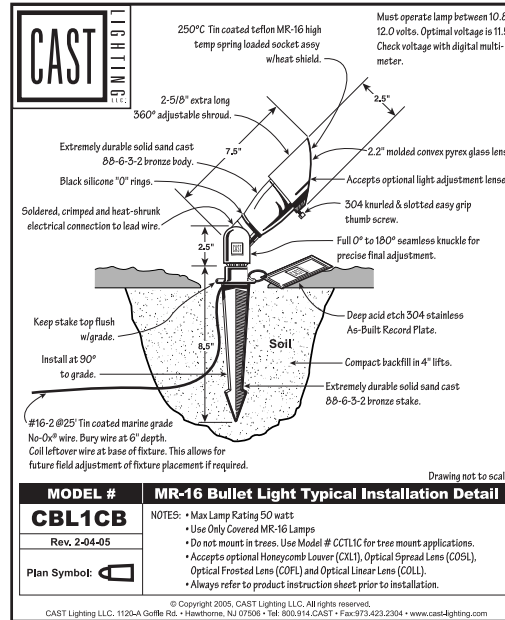
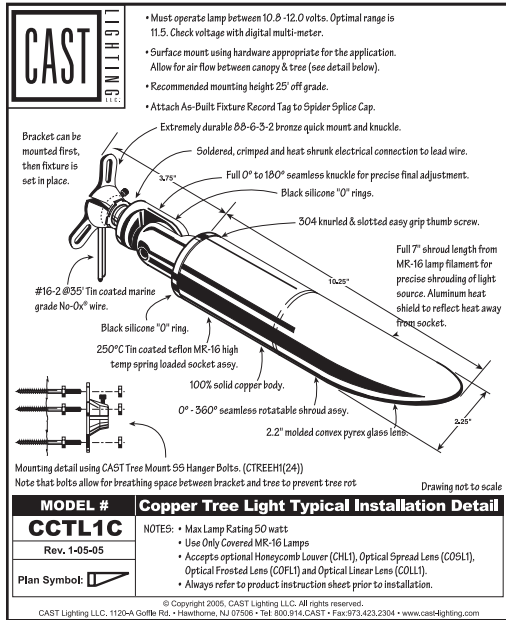

ATTENTION ARCHITECTS

Here is a sampling of installation details for CAST fixtures. These illustrations are especially useful for designers and architects. They can be inserted into lighting plans and bids, specifying the desired CAST fixtures. All drawings are available on CD or can be downloaded from www.cast-lighting.com.

THE IMPORTANCE OF DELIVERING THE RIGHT VOLTAGE TO THE LAMP

Halogen lamps should operate between 10.8 and 11.3 volts. Lamps not operating in this range may fail prematurely. To ensure that lamps receive the correct voltage, a high quality multi-tap transformer is required. The multi-tap allows you to compensate for voltage loss in the cable by selecting higher voltage taps when needed.

**THE OPTIMAL VOLTAGE IS
10.8 - 11.3 VOLTS.
THIS IS THE PERFECT RANGE!!!**

TOOLS AND MATERIALS REQUIRED FOR INSTALLATION

- ▶ Digital Clamp-on Amp/Volt Multimeter (CMETER)
- ▶ Wire Strippers (CASTRIP1)
- ▶ Wire Labeling Pad (CMPAD)
- ▶ Numbered Stamping Set and Hand Punch (CSTAMP & CPUNCH)
- ▶ CAST Black/White C61135 Wire Nuts
- ▶ 4 3/4" Romex Strain Relief Connectors
- ▶ Phillips Screwdriver and Hammer
- ▶ Time clock (CTTC, CTDC), Photo Cell (CTPC, CTRPC) (note—don't use Photo Cell alone), or X-10 Control System



Wires are pushed firmly into the trench.



In turf, the trench is easily closed by gently pushing in from both sides.

SPIDER SPLICE STEPS

Step 1 Preparation

At each Spider Splice, pull wire leads through Spider Splice body and pack into hole with soil or gravel. Allow wires to extend 12" outside the Spider Splice body (Fig. 9).

Step 2 Wire Stripping

Separate the two wires from each fixture lead and home run wire to a length of 12". Strip the ends 1", being careful not to cut or nick wire strands. Cut two additional pieces of #16-2 wire to 6" and 8" lengths for test leads. Strip both ends of these wires.

Step 3 Wire Connections

For connections that are fast, easy on the fingers and that never fail, follow the instructions for the CAST Soldering Method (Fig. 10). This method requires setting up a portable soldering station that you use in the field. Once your soldering pot is plugged in and ready, proceed to make the Spider Splice connections. Take one wire from each fixture lead, one wire from the home run, and one of the short test leads, twist them together into a silicon-filled wire nut. Repeat with the remaining wires, twisting them into the second wire nut. Cap off the two test leads with black/white wire nuts.

Step 4 Finishing and Stamping

Gather all wires together and carefully fold them into the Spider Splice body. Be sure to position test leads for easy access.

Using a stamping set, stamp the wire run number on the Spider Splice Cap.

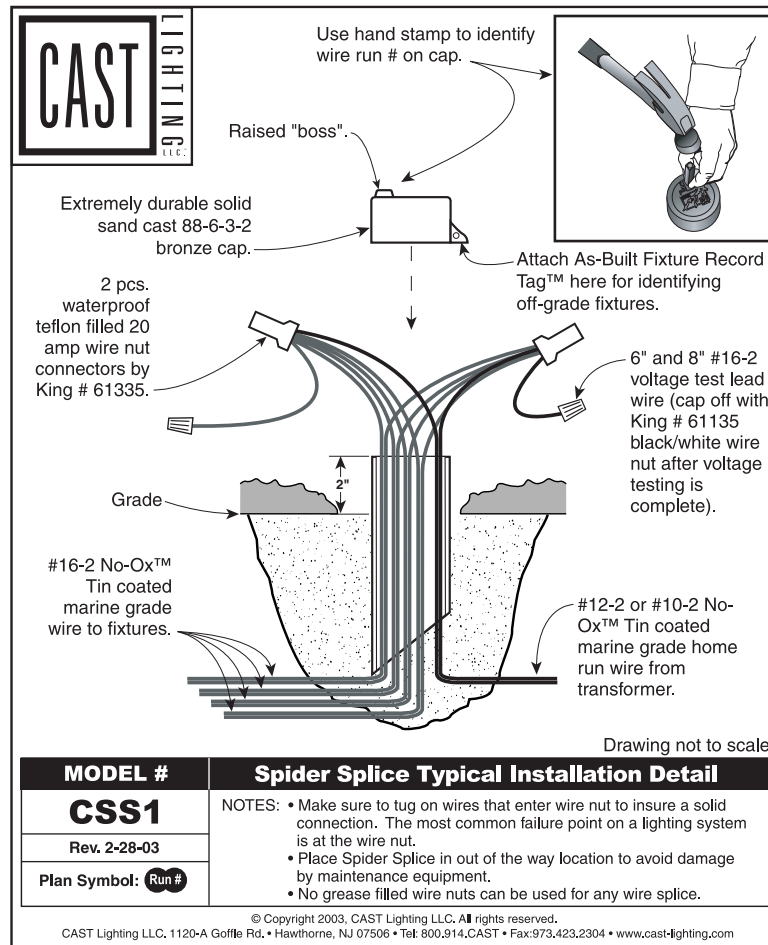

Fig. 9. CAST Spider Splice® connections.

SPIDER SPLICE ADVANTAGES

- ▶ Lightning fast installation.
- ▶ Reduces labor costs, saves money.
- ▶ Less field splices, reduces the chance of splice failures by 80% over other methods of wiring.
- ▶ Even voltage distribution to each fixture. Lamps operate at the same voltage — same light output.
- ▶ Lamps burn out at the same rate. Maintenance is more predictable.
- ▶ Adjustment of the fixtures in the field requires no additional wire splicing since the extra lead wire is placed at the base of the fixture.
- ▶ Individually troubleshoot each fixture at Spider Splice to eliminate guesswork.
- ▶ Reduces Repetitive Strain Injury (RSI) with employees installing wire splices.
- ▶ Spider Splice identifies the wire run # from the transformer.
- ▶ If a Spider Splices becomes buried, it can be located with a metal detector.

The CAST Soldering Method

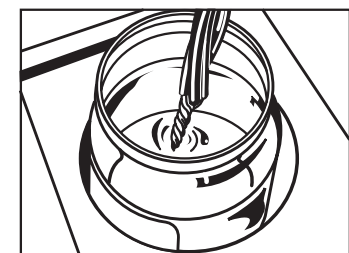
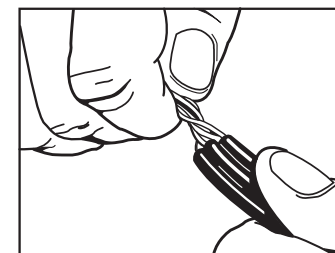
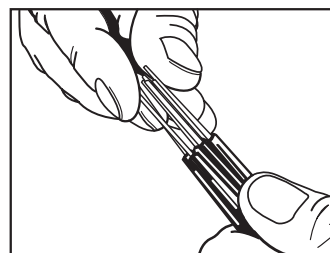

Fig. 10. Soldering Kit & Tote available from your CAST distributor.

Strip wires 1 1/4", twist each exposed wire, line up wires

→ Twist wires together

→ Dip into flux



⚠ Caution: Solder is extremely hot; wear eye protection and keep away from children.

120 VOLT PRIMARY POWER

- ▶ Install nothing smaller than a #10 gauge wire from the breaker panel to the outdoor transformer outlet locations.
- ▶ Install either:
 - A. #10-3 (with ground) direct burial wire to the outlet locations, or
 - B. 1" Schedule 40 PVC conduit installed with five #10 stranded THHN wires. Green, Black, White, Yellow & Red to each transformer stand location.
- ▶ Install a 20 amp primary breaker (GFCI protected) in the breaker panel with a 20 amp outlet receptacle.
- ▶ Install waterproof exterior boxes.
- ▶ Install Tay-Mac or equal outlet covers that are approved "waterproof while in use". UL Listed outlet covers.
- ▶ All primary 120 volt electric must be done by a licensed electrician.
- ▶ Follow all applicable local electric/building codes.

Fig.12. 120 Volt Primary Power Guidelines

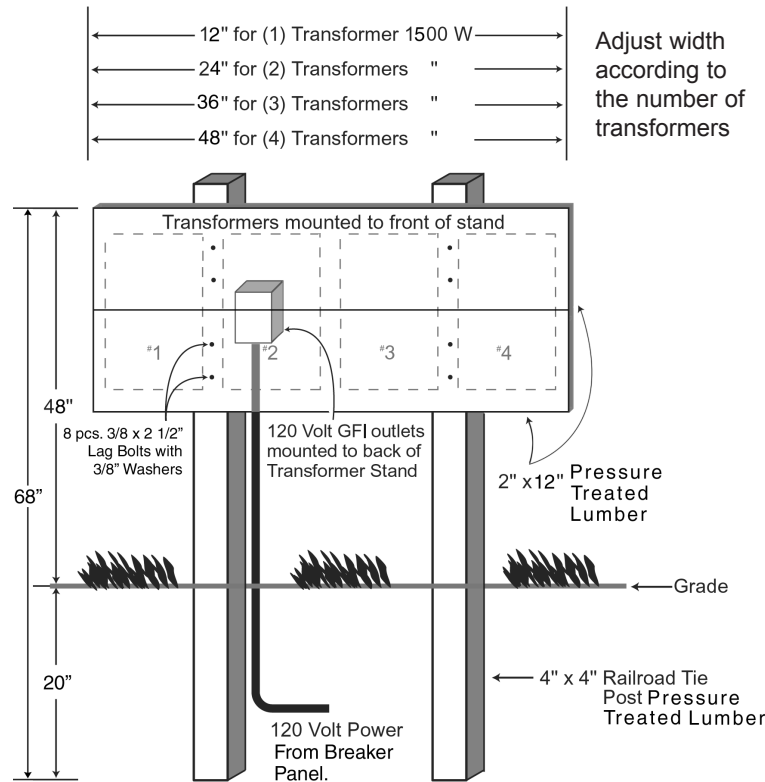

Fig.11. Transformer Stand Assembly

TRANSFORMER STAND STEPS

Cut Lumber

Step 1

Determine width of stand according to the number of transformers (Fig. 11). Cut lumber to indicated lengths.

Assemble Stand

Step 2

Pre-drill bolt holes and securely bolt cross pieces to legs.

Insert Stand

Step 3

Insert stand into holes. Use a level to ensure that the stand is both vertically and horizontally level. Pack legs tightly with soil or gravel.

Mount Transformer(s)

Step 4

Using screws provided, mount transformer(s) onto stand.

Note – transformers can also be mounted to existing structures, but should never be mounted to vinyl siding or in areas where a fire hazard exists.

→ Dip into solder → Dip into water → Trim excess → Twist until tight

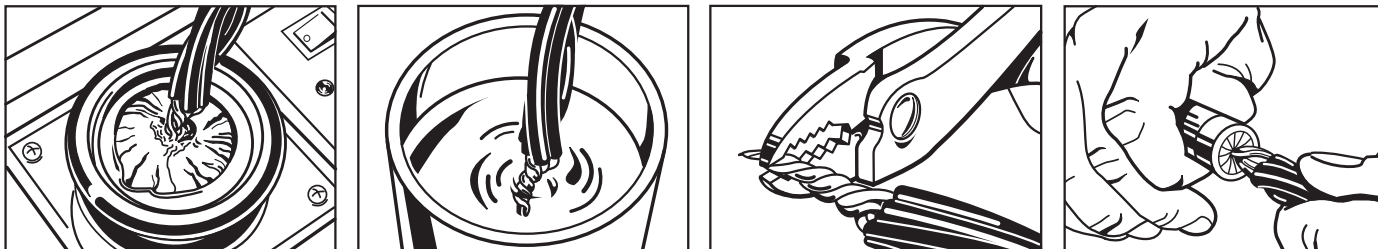

This method is quick, easy, reduces finger strain and results in a connection that will never fail!

Transformer Sizing for LED Lighting Systems

ADJUSTMENT STEPS

Step 1

A. Count up all you LED fixtures and add up the total VOLT AMPS

B. In Addition to the Volt Amps you will also need to calculate the Resistance in the wire in order to size the transformer you will use as well as provide a buffer for additional lights that might be required. Simple rule add 40%. So a system using 90.2 fixture Volt Amps X 40% = 36 watts

Add: 90.2 volt amps

**Plus: 40% wire and Extra Space
36.00 watts**

**= 126.20 Watts or larger
transformer**

Qty:	Part #	Description :	Watts	Power Factor	Volt Amps	Total VA
4	CCSL25036	Craftsman Spot Light Bronze 229 Lumen 34°	4.3	0.82	5.24	20.96
4	CCSL10536B	Craftsman Spot Light Bronze 89 Lumen 31°	2.8	0.89	3.15	12.6
6	CCW270B	Craftsman Wash Light 164 Lumen 87°	4.33	0.9	4.81	28.86
4	CCPL1	Craftsman Path Light	4.22	0.89	4.74	18.96
2	CTLED141	Classic Tree Moon Light Low Setting 157 Lumen 30°	4.1	0.93	4.41	8.82
					Total VA	90.2

NOTE : The WATTS to operate (or Consumed Wattage) is Different than the Volt Amps. Volt amps takes into account the inefficiency in the AC driver that runs the Light Emitting Diode. Because of this inefficiency you need a larger transformer to run the system even though the actual watts you consume is less. What you actually pay for is watts NOT Volt Amps:

Qty:	Part #	Description :	Watts	Power Factor	Volt Amps	Watts
4	CCSL25036	Craftsman Spot Light Bronze 229 Lumen 34°	4.3	0.82	5.24	17.2
4	CCSL10536B	Craftsman Spot Light Bronze 89 Lumen 31°	2.8	0.89	3.15	11.2
6	CCW270B	Craftsman Wash Light 164 Lumen 87°	4.33	0.9	4.81	25.98
4	CCPL1	Craftsman Path Light	4.22	0.89	4.74	16.88
2	CTLED141	Classic Tree Moon Light Low Setting 157 Lumen 30°	4.1	0.93	4.41	8.2
					Total Watts	79.46

Maximum Wattage Capacity of Wire **Step 2 & 3**

Wire Size	Wire Amperage Rating	80% of AMPERAGE capacity (A)	12 VOLTS	MAX WATTAGE Wire Capacity @ 12 Volts	RECOMMEND wire WATTAGE load NO MORE THAN 75% (B)
#18-2	6	4.8	12	57.6	43.20
#16-2	10	8	12	96	72.00
#14-2	15	12	12	144	108.00
#12-2	20	16	12	192	144.00
#10-2	30	24	12	288	216.00
(A) as per NEC do not load more than 80% any wire operating longer than 3 hours.					
(B) Using 75% gives you room to add lights if needed					

Step 2:
If you plan on running all these lights on one wire run you need to use a wire that can handle greater than 79.46 watts PLUS the watts consumed by the wire. #14-2 seems good and #12-2 would also work.

Step 3:
THE WIRE GAUGE YOU USE IS A FUNCTION OF THE DISTANCE OF THE WIRE RUN (RESISTANCE) AND THE LOAD ON THE WIRE RUN

Example #1: A Simple grouping of seven fixtures on a single wire run.

Wire Size	Resistance per foot
#18-2	0.006385
#16-2	0.004016
#14-2	0.002525
#12-2	0.00162
#10-2	0.00108
#8-2	0.00064

	Group A	Wattage	DISTANCE From Transformer to First GROUPING of Fixtures	
	DISTANCE		100	
Lay Out System	FIXTURE # 1 Group A Wattage	4.3		
	FIXTURE # 2 Group A Wattage	4.3		
	FIXTURE # 3 Group A Wattage	4.3		
	FIXTURE # 4 Group A Wattage	4.3		
	FIXTURE # 5 Group A Wattage	4.1		
	FIXTURE # 6 Group A Wattage	4.1		
	FIXTURE # 7 Group A Wattage	10		
Consumed Wattage	TOTAL Wattage Group A	35.4		
	TOTAL SYSTEM WATTAGE	35.4		Total Wattage of all Fixtures
	TOTAL DISTANCE		100	
	watts / 12= AMPS	2.95		
	Amps x Distance x 2 x Resistance per foot = Voltage Drop	X		Divide the WATTS by 12 volts to calculate AMPS
Select Wire gauge		100		
		X		
		2		
	Resistance per foot	X		
	#14-2	0.002525		
	#12-2	0.00162		
	#10-2	0.00108		
Voltage Loss and Operating Volts	Voltage Loss # 14-2	1.48975		This is the RESISTANCE in the wire = Voltage loss. 1.48975 volts lost due to Resistance
	Voltage Loss # 12-2	0.9558		
	Voltage Loss # 10-2	0.6372		
	Total Distance	100		
	Enter Starting Voltage	16		Take Voltage Tap at transformer 16 minus wire voltage loss of 1.48975 = the Voltage <u>at</u> the fixtures 100 feet away
	First Grouping Voltage	14.51025		
		VOLTS	Amps	
	Total VOLTAGE Loss	1.48975	2.95	

	Cable Loss	4.3947625	
	Fixtures Consumed	35.4	
	Total Watts Consumed	39.7947625	

Now in this example our cable loss of 1.48975 x amps of 2.95 = 4.394 WATTS. We add that to ALL THE FIXTURES TOTAL WATTAGE OF 35.4 AND YOU HAVE THE TOTAL SYSTEMS WATTAGE THAT YOU WILL PAY MONEY FOR and YOU NEED A TRANSFORMER WITH THIS CAPACITY OR LARGER TO OERATE THIS SYSTEM

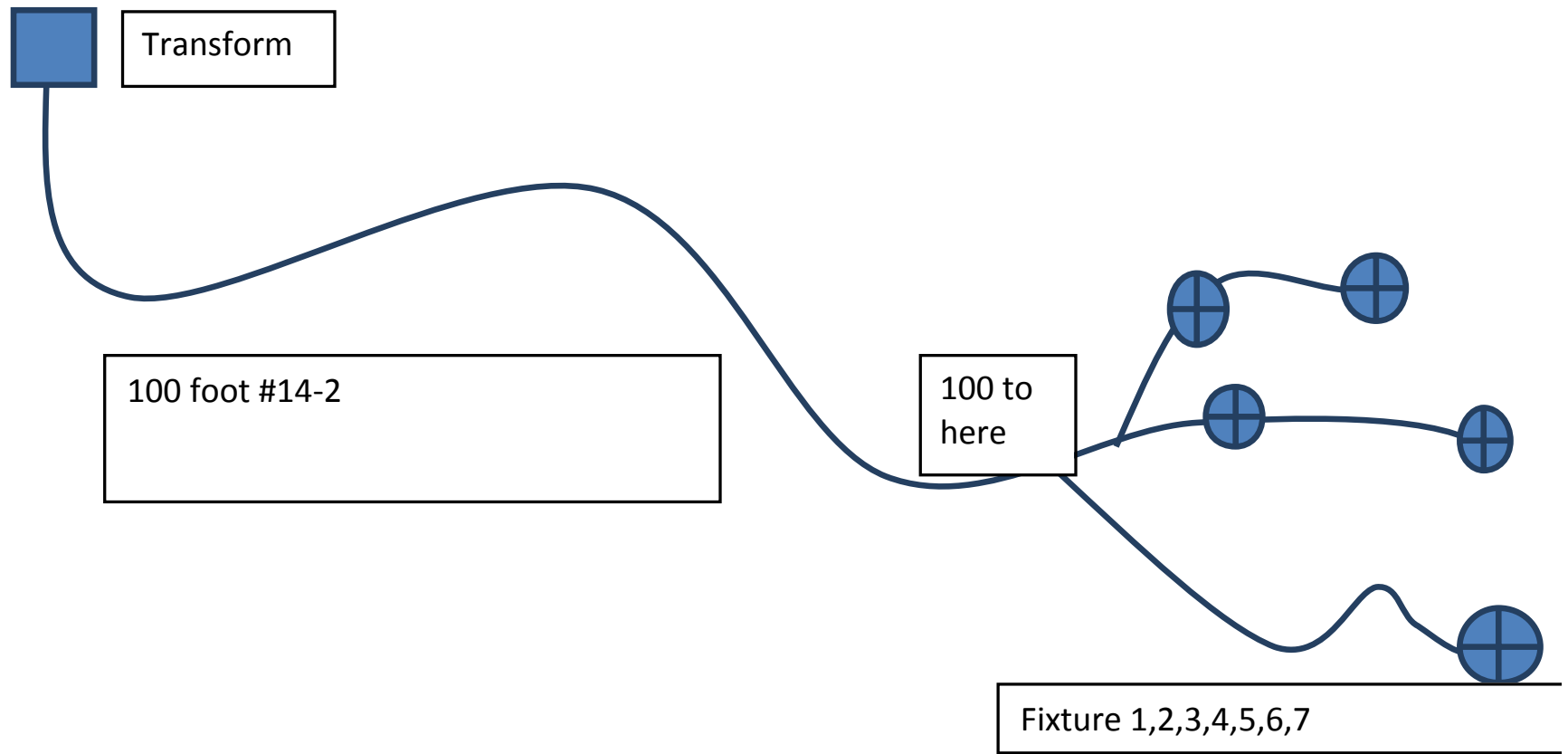

Transformer

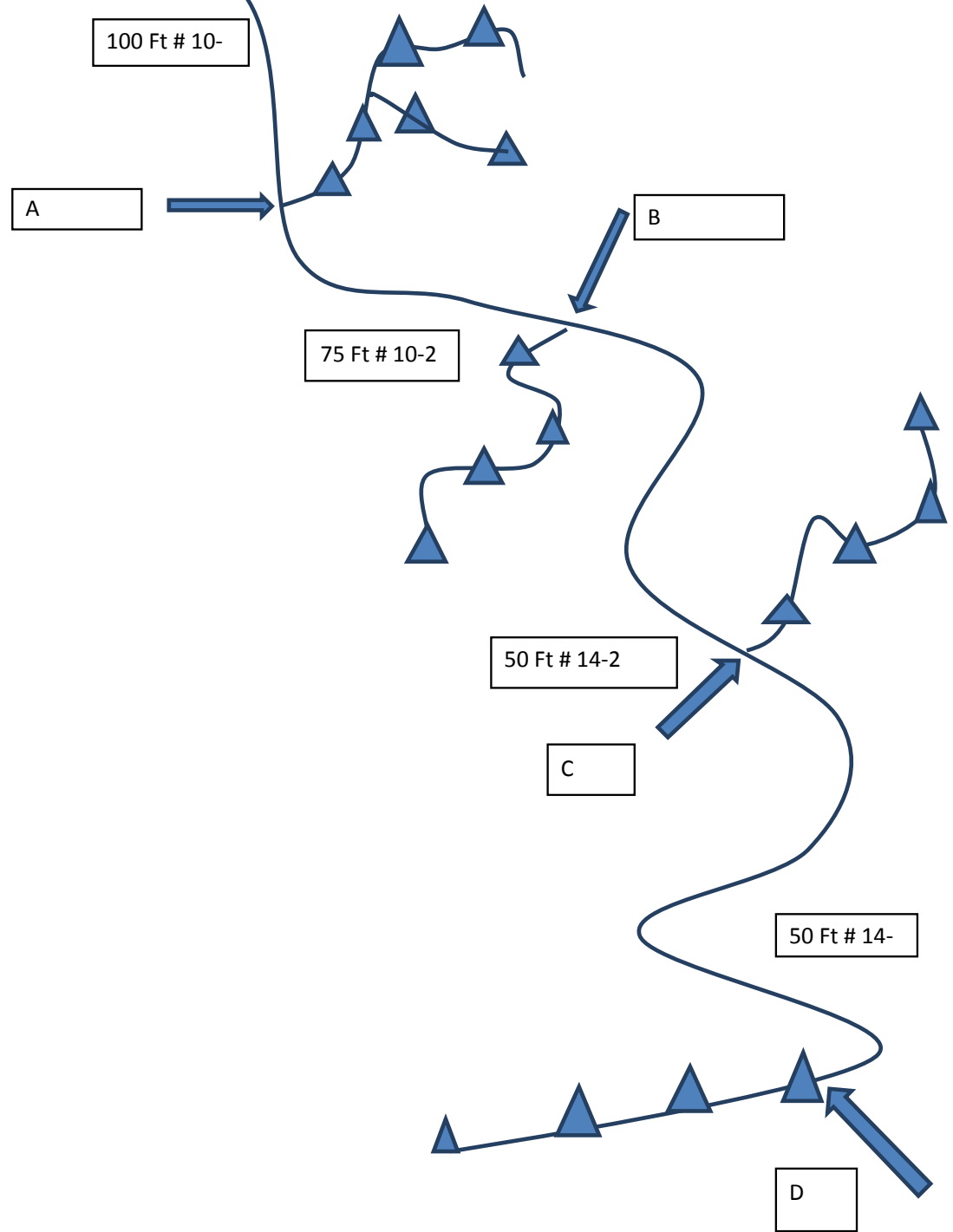

This Sheet is for determining the voltage loss in the wire

	Group A		Group B		Group C		Group D	
	Wattage	DISTANCE From Transformer to First GROUPING of Fixtures	Wattage	DISTANCE From First GROUPING of Fixtures to SECOND GROUPING	Wattage	DISTANCE From Second GROUPING of Fixtures to Third GROUPING of fixtures	Wattage	DISTANCE From Third GROUPING of Fixtures to Fourth GROUPING of fixtures
DISTANCE		100		75		50		50
Fixtures on run	7		4		4		4	
FIXTURE # 1 Group A Wattage	4.3		FIXTURE # 1 Group B Wattage	2.8	FIXTURE # 1 Group C Wattage	4.33	FIXTURE # 1 Group D Wattage	4.22
FIXTURE # 2 Group A Wattage	4.3		FIXTURE # 2 Group B Wattage	2.8	FIXTURE # 2 Group C Wattage	4.33	FIXTURE # 2 Group D Wattage	4.22
FIXTURE # 3 Group A Wattage	4.3		FIXTURE # 3 Group B Wattage	2.8	FIXTURE # 3 Group C Wattage	4.33	FIXTURE # 3 Group D Wattage	4.22
FIXTURE # 4 Group A Wattage	4.3		FIXTURE # 4 Group B Wattage	2.8	FIXTURE # 4 Group C Wattage	4.33	FIXTURE # 4 Group D Wattage	4.22
FIXTURE # 5 Group A Wattage	4.1		FIXTURE # 5 Group B Wattage	0	FIXTURE # 5 Group C Wattage	0	FIXTURE # 5 Group D Wattage	0
FIXTURE # 6 Group A Wattage	4.1		FIXTURE # 6 Group B Wattage	0	FIXTURE # 6 Group C Wattage	0	FIXTURE # 6 Group D Wattage	0
FIXTURE # 7 Group A Wattage	10		FIXTURE # 7 Group B Wattage	0	FIXTURE # 7 Group C Wattage	0	FIXTURE # 7 Group D Wattage	0
Total Fixtures	19							
TOTAL Wattage Group A	35.4		TOTAL Wattage Group B	11.2	TOTAL Wattage Group C	17.32	TOTAL Wattage Group D	16.88
TOTAL Wattage Group B	11.2		TOTAL Wattage Group C	17.32	TOTAL Wattage Group D	16.88		
TOTAL Wattage Group C	17.32		TOTAL Wattage Group D	16.88				
TOTAL Wattage Group D	16.88							
TOTAL SYSTEM WATTAGE	80.8			45.4		34.2		16.88
TOTAL DISTANCE		100		75		50		50
watts / 12= AMPS	6.73333333		watts / 12= AMPS	3.78333333	watts / 12= AMPS	2.85	watts / 12= AMPS	1.40666667
Amps x Distance x 2 x	X		X		X		X	
Resistance per foot = Voltage Drop	100		75		50		50	
	X		X		X		X	
	2		2		2		2	
Resistance per foot	X		Resistance per foot	X	Resistance per foot	X	Resistance per foot	X
#14-2	0.002525		#14-2	0.002525	#14-2	0.00253	#14-2	0.002525
#12-2	0.00162		#12-2	0.00162	#12-2	0.00162	#12-2	0.00162
#10-2	0.00108		#10-2	0.00108	#10-2	0.00108	#10-2	0.00108
Voltage Loss # 14-2	3.40033333		Voltage Loss # 14-2	1.4329375	Voltage Loss # 14-2	0.71963	Voltage Loss # 14-2	0.35518333
Voltage Loss # 12-2	2.1816		Voltage Loss # 12-2	0.91935	Voltage Loss # 12-2	0.4617	Voltage Loss # 12-2	0.22788
Voltage Loss # 10-2	1.4544		Voltage Loss # 10-2	0.6129	Voltage Loss # 10-2	0.3078	Voltage Loss # 10-2	0.15192
Total Distance	275							
Enter Starting Voltage	16							
First Grouping Voltage	14.5456		Second Grouping Voltage	13.9327	Third Grouping Voltage	13.2131	Fourth Grouping Voltage	12.8578917
		Amps		Watts				
Total VOLTAGE Loss	3.142108333	6.7333333	21.15686278					
Last Fixture Voltage	12.85789167		Amps X Volts =Watts					
Cable Loss	21.15686278							
Fixtures Consumed	80.8							
Total Watts Consumed	101.9568628							

CAST Lighting Independent LM-79 Test Results for Integrated LED Directional SPOT Lights. Electrical and Photometric Test Results

Halogen Equivalent LED Data Reference Sheet (Feb 16, 2015)

Old World Craftsmanship...Tomorrow's Technology™

All specifications as per LM-79. Integrated LED fixtures tested @ 12 Volts AC. Halogen Reference tested at 11.5V AC in a CBL1CB Cast Spot Light.

Foot Candles = CBCP/
Distance Squared

At 10 feet At 20 feet

Distance Sq. Distance Sq.

100 400

Spot Lights

	Dimmer Level Setting in BARS Impressionist Series Only	% of total output Impressionist Series	Voltage Range AC or DC	Amps	Watts (Cost ro operate)	Power Factor	Volt Amps (Use This # To Size Transformer)	Efficacy (lumens Per Watt Consumed)	CRI	L-70 Hrs	Color Temp	Actual Beam (Angle at 50% of Candela)	Total Lumens	Center Beam Candela (CBCP)	Beam Lumens	Foot Candles in center at 10' Ft. (Illuminance)	Foot Candles in center at 20' Ft (Illuminance)
10 Watt Halogen 36° (DMB)			11.5	0.76	8.75	1	8.75	5	100	NA	2697	31°	48	168	30	1.68	0.42
CCSL10536B or S			10-24	0.26	2.8	0.89	3.15	32	81	51,400	2736	28°	89	358	54	3.58	0.895
CID140 Series 40' Optic	Three	30%	10-24	0.122	1.309	0.871	1.50	60	80	51,400	2776	40°	79	153	39	1.53	0.3825
CID248 Series 48' Optic	Five	50%	10-24	0.069	1.59	0.804	0.85	62	80	51,400	2747	48°	99	139	62	1.39	0.3475
Wall Wash Data Provided for Comparative Reference Purposes.																	
CCW270 Wash / CWW1LED2			10-24	0.4	4.33	0.9	4.81	38	82	60,500	2758	87°	164	94	118	0.9442	0.23605
CCDL1 Craftsman Deck Light			10-24	0.27	2.88	0.88	3.27	31	82	60,500	2784	87°	89	46	52	0.46	0.115
CWL6LED1 Hi-Power Wall Wash W/Shroud			10-24	0.47	5.01	0.88	5.69	24	82	60,500	2801	81°x53°	122	90	67	0.8981	0.224525
CIWL6 Impressionist Wall Wash W/ Shroud	Ten	100%	10-24	0.73	7.63	0.88	8.67	38	82	51,400	2710	85°x62°	292	184	189	1.84	0.46
20 Watt Halogen 36° (BAB)			11.5	1.67	19.19	1	19.19	6	100	NA	2780	32°	121	387	85	3.8742	0.96855
CCSL18336B or S			10-24	0.25	2.69	0.88	3.06	57	80	51,400	2794	34°	153	417	85	4.17	1.0425
CCSL18354B			10-24	0.26	2.68	0.87	3.08	57	79	51,400	2885	44°	153	238	81	2.38	0.595
CID140 Series 40' Optic	Seven	70%	10-24	0.283	3.22	0.929	3.47	61	80	51,400	2776	40°	197	379	96	3.79	0.9475
CID248 Series 48' Optic	Eight	80%	10-24	0.217	4.73	0.947	4.99	57	80	51,400	2747	48°	269	378	169	3.78	0.945
CTLED141 Low Setting STD			10-24	0.37	4.1	0.93	4.41	38	81	60,500	2559	30°	157	567	87	5.67	1.4175
35 Watt Halogen 36° (FMW)			11.5	2.72	31.39	1	31.39	7	100	NA	2753	32°	218	625	135	6.2511	1.562775
CCSL25036B			10-24	0.42	4.3	0.82	5.24	53	79	51,400	2816	34°	229	665	135	6.65	1.6625
CBLED141 Low			10-24	0.52	5.86	0.93	6.30	46	80	60,500	2720	30°	269	781	115	7.81	1.9525
CID140 Series 40' Optic	Ten	100%	10-24	0.47	5.05	0.886	5.70	54	80	51,400	2776	40°	273	526	134	5.26	1.315
CID248 Series 48' Optic	Ten	100%	10-24	0.804	8.74	0.91	9.60	51	80	51,400	2747	48°	449	630	281	6.3	1.575
CTLED141 Hi Setting			10-24	0.52	5.86	0.93	6.30	46	80	60,500	2720	30°	269	781	115	7.81	1.9525
50 Watt Halogen 36° (EXN)			11.5	3.76	43.44	1	43.44	7	100	NA	2778	28°	296	1028	183	10.28	2.57
CBLED141 High Setting STD			10-24	0.82	9.25	0.94	9.84	35	80	60,500	2720	32°	328	946	155	9.46	2.365
CID140 Series 24' Optic	nine	90%	10-24	0.414	4.55	0.903	5.04	64	80	51,400	2777	25°	289	1162	124	11.62	2.905
CID248 Series 24' Optic	Eight	80%	10-24	0.401	4.73	0.964	4.91	62	80	51,400	2747	24°	293	1114	106	11.14	2.785
75 Watt Halogen 36° (EYC)			11.5	5.56	64.16	1	64.16	9	100	NA	2991	28°	551	2123	267	21.23	5.3075
CID248 Series 24' Optic	Ten	100%	10-24	0.804	8.74	0.91	9.60	56	80	51,400	2747	24°	489	1856	177	18.56	4.64

Cast LM-79 Impressionist Technical Data

Technical Specifications CAST Lighting Impressionist Series CID140 and CID248 Integrated LED Directional SPOT Light (02-2015)																Foot Candles = CBCP / Distance Squared	
All specifications derived from LM-79 testing performed at full power @ 12 Volts AC. Higher drive current of 24V A/C Will increase below values by 10% (*)																At 10 Feet	At 20 Feet
Data is for model #, CID140 Spot, CIDA140 Area Light, CIT164 Tree Light Fitted with a model # CIDO40 Optic																Distance Sq.	Distance Sq.
Data is for model #, CID248 Spot, CIDA248 Area Light, CIT265 Tree Light Fitted with a model # 2XCIDO48 Optic																100	400
40°/48° Wide	Dimmer Level Setting in BARS	% of total output	Voltage Range AC or DC	Amps	Watts	Power Factor	Volt Amps	Efficacy (Lumens Per Watt Consumed)	CRI	L-70 Hrs	Color Temp	Actual Beam (Angle at 50% of Candela)	Total Lumens	Center Beam Candela (CBCP)	Beam Lumens	Foot Candles in Center at 10' Ft. (Illuminance)	Foot Candles in Center at 20' Ft. (Illuminance)
CID140 Series 40° Optic (*)	min.	0%	10-24	0.031	0.25	0.660	0.38	55	80	51,400	2776	40°	14	26	7	0.26	0.07
CID140 Series 40° Optic (*)	one	10%	10-24	0.064	0.6	0.760	0.79	64	80	51,400	2776	40°	38	74	19	0.74	0.18
CID140 Series 40° Optic (*)	two	20%	10-24	0.082	0.8	0.802	1.00	65	80	51,400	2776	40°	52	100	25	1.00	0.25
CID140 Series 40° Optic (*)	three	30%	10-24	0.122	1.309	0.871	1.50	60	80	51,400	2776	40°	79	153	39	1.53	0.38
CID140 Series 40° Optic (*)	four	40%	10-24	0.163	1.81	0.909	1.99	63	80	51,400	2776	40°	115	221	56	2.21	0.55
CID140 Series 40° Optic (*)	five	50%	10-24	0.174	1.935	0.904	2.14	63	80	51,400	2776	40°	123	237	60	2.37	0.59
CID140 Series 40° Optic (*)	six	60%	10-24	0.202	2.2	0.885	2.49	65	80	51,400	2776	40°	142	274	70	2.74	0.68
CID140 Series 40° Optic (*)	seven	70%	10-24	0.283	3.22	0.929	3.47	61	80	51,400	2776	40°	197	379	96	3.79	0.95
CID140 Series 40° Optic (*)	eight	80%	10-24	0.317	3.53	0.914	3.86	59	80	51,400	2776	40°	207	400	102	4.00	1.00
CID140 Series 40° Optic (*)	nine	90%	10-24	0.414	4.55	0.903	5.04	55	80	51,400	2776	40°	251	484	123	4.84	1.21
CID140 Series 40° Optic (*)	ten	100%	10-24	0.470	5.05	0.886	5.70	54	80	51,400	2776	40°	273	526	134	5.26	1.32
																	0.00
CID248 Series 48° Optic(*)	min.	0%	10-24	0.026	0.22	0.694	0.32	49	80	51,400	2747	48°	11	15	7	0.15	0.04
CID248 Series 48° Optic(*)	one	10%	10-24	0.06	0.58	0.786	0.74	62	80	51,400	2747	48°	36	50	22	0.50	0.13
CID248 Series 48° Optic(*)	two	20%	10-24	0.069	0.68	0.804	0.85	66	80	51,400	2747	48°	45	63	28	0.63	0.16
CID248 Series 48° Optic(*)	three	30%	10-24	0.109	1.17	0.880	1.33	58	80	51,400	2747	48°	67	95	42	0.95	0.24
CID248 Series 48° Optic(*)	four	40%	10-24	0.125	1.35	0.883	1.53	60	80	51,400	2747	48°	81	113	51	1.13	0.28
CID248 Series 48° Optic(*)	five	50%	10-24	0.146	1.59	0.896	1.77	62	80	51,400	2747	48°	99	139	62	1.39	0.35
CID248 Series 48° Optic(*)	six	60%	10-24	0.217	2.5	0.947	2.64	61	80	51,400	2747	48°	153	214	96	2.14	0.54
CID248 Series 48° Optic(*)	seven	70%	10-24	0.269	3.13	0.955	3.28	62	80	51,400	2747	48°	193	271	121	2.71	0.68
CID248 Series 48° Optic(*)	eight	80%	10-24	0.401	4.73	0.964	4.91	57	80	51,400	2747	48°	269	378	169	3.78	0.95
CID248 Series 48° Optic(*)	nine	90%	10-24	0.505	5.88	0.958	6.14	60	80	51,400	2747	48°	350	491	219	4.91	1.23
CID248 Series 48° Optic(*)	ten	100%	10-24	0.804	8.74	0.910	9.60	51	80	51,400	2747	48°	449	630	281	6.30	1.58

Cast LM-79 Path Area Light Technical Data

Technical Specifications CAST Lighting Path Area Lights (02-2015)														Foot Candles = CBCP / Distance Squared
All specifications derived from LM-79 testing performed at full power @ 12 Volts AC. Higher drive current of 24V A/C Will increase below values by 10% (*)														At 10 Feet
Fixtures Below fitted with CALED2 LED Retrofit Module (A)														Distance Sq.
														100
Path / Area Lights	Voltage Range AC or DC	Amps	Watts	Power Factor	Volt Amps	Lumiere Efficacy Rating (LER) (Total Lumens per watt consumed)	CRI	L-70 Hrs	Color Temp	Total Lumens	Maximum Candela	45° Candela	BUG Rating	Foot Candles in Center at 10' Ft. (Illuminance)
CMU1CB Small Mushroom (*) (A)	10-24	0.41	4.4	0.890	4.94	24.00	82	62,000	2769	104	37	28	0,0,0,	0.37
CMU2CB Large Mushroom (*) (A)	10-24	0.39	4.22	0.910	4.64	31.04	83	62,000	2809	131	57	34	0,0,0	0.57
CCH5LED1 Mini China Hat	10-24	0.27	2.71	0.840	3.23	21.48	81	62,000	2829	58	18	13	0,1,0	0.18
CCH1CB Small China Hat (*) (A)	10-24	0.41	4.42	0.890	4.97	18.55	82	62,000	2797	82	21	19	0,0,0	0.21
CCH2CB Large China Hat (*) (A)	10-24	0.39	4.23	0.910	4.65	27.42	83	62,000	2804	116	39	29	0,0,0	0.39
CNO1CB New Orleans (*) (A)	10-24	0.42	4.42	0.890	4.97	29.19	82	62,000	2808	129	43	35	0,1,0	0.43
CSA1CB Savannah (*) (A)	10-24	0.4	4.41	0.910	4.85	45.35	82	62,000	2737	200	94	49	0,0,0	0.94
CISX2CB Insignia (*) (A)	10-24	0.39	4.23	0.910	4.65	27.42	83	62,000	2804	116	39	29	0,0,0	0.39
CCPL1 & 2 Craftsman (*)	10-24	0.4	4.22	0.890	4.74	27.01	82	62,000	2790	114	46	30	0,0,0	0.46

Cast Lighting LM-79 LED Test Results For Deck, Engineered Wall and Wash Lights.

CAST Lighting Independent LM-79 Test Results for Integrated LED Deck, Engineered Wall Lights & Wash Lights.																	= CBCP/ Distance
Electrical and Photometric Test Results																	At 10 feet
Old World Craftsmanship...Tomorrow's Technology tm																	Distance Sq.
All specifications as per LM-79. Integrated LED fixtures tested @ 12 Volts AC. Higher drive current of 24V A/C Will increase below values by 10% (*)																	100
Deck, Engineered Wall & Wash Lights	Dimmer Level Setting in BARS Impressionist Series Only	% of total output Impressionist Series	Voltage Range AC or DC	Amps	Watts (Cost to operate)	Power Factor	Volt Amps (Use This # To Size Transformer)	Efficacy (lumens Per Watt Consumed)	CRI	L-70 Hrs	Color Temp	Horizontal Beam (Angle at 50% of Candela)	Vertical Beam (Angle at 50% of Candela)	Total Lumens	Center Beam Candela (CBCP)	Beam Lumens	Foot Candles in center at 10' Ft. (Illuminance)
Deck Lights																	
CCDL1B or S Craftsman Deck Light (*)			10-24	0.27	2.88	0.88	3.27	31	82	60,500	2787	88°	88°	89	46	52	0.46
CDL1CBLED1 Round Classic Deck Light (*)			10-24	0.27	2.82	0.88	3.20	17	81	60,500	2759	97°	69°	49	29	36	0.294
Engineered Wall Lights																	
CEWL5LED1 / CEWL6LED1 Engineered Wall Light (*)			10-24	0.24	2.5	0.88	2.84	30	81	60,500	2704	94°	78°	76.06	38	45	0.38
CEWL6LED1 /CEWL6LED1 Minus Reflector (*)			10-24	0.24	2.5	0.88	2.84	14	80	60,500	2704	94°	78°	36	18	28	0.18
Wash Lights																	
CCW270B or S Craftsman Wash (*)			10-24	0.4	4.33	0.9	4.81	38	82	60,500	2758	92°	84°	164	94	118	0.9442
CWW1LED2 Classic Wash Light (*)			10-24	0.4	4.33	0.9	4.81	34	82	60,500	2758	84°	84°	147.6	85	106	0.84978
CWL6LED1 Hi-Power Wall Wash W/Shroud (*)			10-24	0.47	5.01	0.9	5.57	24	82	60,500	2801	81°	53°	122	90	67	0.8981
CIWL6 Impressionist Wall Wash W/ Shroud (*)	Min.	0%	10-24	0.04	0.22	0.694	0.32	66	82	51,400	2710	85°	62°	14.6	9	9.45	0.092
CIWL6 Impressionist Wall Wash W/ Shroud (*)	One	10%	10-24	0.069	0.58	0.786	0.74	50	82	51,400	2710	85°	62°	29.2	18	18.9	0.184
CIWL6 Impressionist Wall Wash W/ Shroud (*)	Two	20%	10-24	0.07	0.6	0.804	0.75	97	82	51,400	2710	85°	62°	58.4	37	37.8	0.368
CIWL6 Impressionist Wall Wash W/ Shroud (*)	Three	30%	10-24	0.11	1.17	0.88	1.33	75	82	51,400	2710	85°	62°	87.6	55	56.7	0.552
CIWL6 Impressionist Wall Wash W/ Shroud (*)	Four	40%	10-24	0.125	1.35	0.883	1.53	87	82	51,400	2710	85°	62°	116.8	74	75.6	0.736
CIWL6 Impressionist Wall Wash W/ Shroud (*)	Five	50%	10-24	0.146	1.6	0.896	1.79	91	82	51,400	2710	85°	62°	146	92	94.5	0.92
CIWL6 Impressionist Wall Wash W/ Shroud (*)	Six	60%	10-24	0.217	2.5	0.947	2.64	70	82	51,400	2710	85°	62°	175.2	110	113	1.104
CIWL6 Impressionist Wall Wash W/ Shroud (*)	Seven	70%	10-24	0.269	3.13	0.955	3.28	65	82	51,400	2710	85°	62°	204.4	129	132	1.288
CIWL6 Impressionist Wall Wash W/ Shroud (*)	Eight	80%	10-24	0.401	4.73	0.964	4.91	49	82	51,400	2710	85°	62°	233.6	147	151	1.472
CIWL6 Impressionist Wall Wash W/ Shroud (*)	Nine	90%	10-24	0.505	5.88	0.958	6.14	45	82	51,400	2710	85°	62°	262.8	166	170	1.656
CIWL6 Impressionist Wall Wash W/ Shroud (*)	Ten	100%	10-24	0.73	7.63	0.88	8.67	38	82	51,400	2710	85°	62°	292	184	189	1.84

Report No: L111407103

See Definition Sheet

Report Prepared For: Cast Lighting
1120-A Goffle Rd., Hawthorne, NJ., 07506

Model Number: CCSL18336

Product MFG Model # Tested

Test: Electrical and Photometric tests

Standards Used: Appropriate part or all test guidelines were used for test performed:
IESNA LM79: 2008 Approved Methods for Electrical and Photometric Measurements of Solid-State Lighting Products
ANSI NEMA ANSLG C78.377: 2008 Specification of the Chromaticity of Solid State Lighting Products
ANSI C82.77:2002: Harmonic Emission Limits-Related Quality Requirements for Lighting Equipment

Description of Sample: Client submitted the sample. Catalog number is CCSL18336. Received in working and undamaged condition. No modifications were necessary.

Testing Condition: Fixture is tested with no special conditions.

Sample Arrival Date: 12/4/14

Date of Tests: 12/8/14 - 12/9/14

Seasoning of Sample: No seasoning was performed in accordance with IESNA LM-79.

Equipment List

Equipment Used	Model No	Stock No	Calibration Due Date
Chroma Programmable AC Source	61604	PS-AC02	--
Yokogawa Digital Power Meter	WT210	MT-EL06-S1	01/04/15
Xitron Power Analysis System	2503AH	MT-EL01	01/09/15
BK Precision DC Power Supply	1747	PSDC-04	01/08/15
Fluke Digital Thermometer	52kJ	MT-TP02-GC	01/04/15
LLI Type C Goniophotometer System	RMG-C-MKII	CD-LL04-GC	--
LLI 2M Sphere	2MR97	CD-SN03-S2	--
LLI Spectroradiometer	SPR-3000	MT-SC01-S2	Before Use

*All Results in accordance to IESNA LM-79-2008: Approved Method for the Electrical and Photometric Testing of Solid-State Lighting.

Electrical/Color Section

Test Summary	
Manufacturer:	Cast Lighting
Model Number:	CCSL18336
Driver Model Number:	N/A
Total Lumens:	152.94 ← A.
Input Voltage (VAC/60Hz):	12.00
Input Current (Amp):	0.25 ← B.
Input Power (W):	2.69 ← C.
Input Power Factor:	0.88 ← D.
Current ATHD @ 12V(%):	53%
Current ATHD @ 277V(%):	N/A
Efficacy:	57 ← E.
Color Rendering Index (CRI):	80 ← F.
Correlated Color Temperature (K):	2794 ← G.
Chromaticity Coordinate x:	0.4583
Chromaticity Coordinate y:	0.4199
Ambient Temperature (°F):	77.0
Stabilization Time (Hours):	0:35 ← H.
Total Operating Time (Hours):	1:50
Off State Power(W):	0.00



FIG. 1 LUMINAIRE

*All Results in accordance to IESNA LM-79-2008: Approved Method for the Electrical and Photometric Testing of Solid-State Lighting.



8165 E Kaiser Blvd. Anaheim, CA 92808
 p. 714.282.2270
 f. 714.676.5558

Report No: L111407103
 Date: 12/9/2014



NVLAP LAB CODE 200927-0

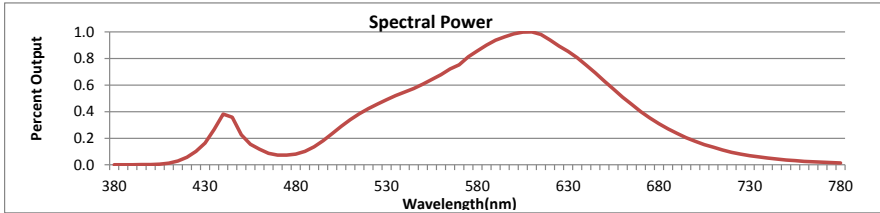

Wavelength	W/m ² nm	440	0.3812	510	0.3408	580	0.8586	650	0.6303	720	0.0946
380	0.0006	450	0.2254	520	0.4239	590	0.9377	660	0.5096	730	0.0694
390	0.0009	460	0.1181	530	0.4909	600	0.9852	670	0.3997	740	0.0505
400	0.0026	470	0.0729	540	0.5477	610	1.0000	680	0.3094	750	0.0367
410	0.0130	480	0.0802	550	0.6071	620	0.9391	690	0.2360	760	0.0264
420	0.0576	490	0.1353	560	0.6781	630	0.8544	700	0.1772	770	0.0195
430	0.1637	500	0.2352	570	0.7525	640	0.7495	710	0.1320	780	0.0144

CRI & CCT

x	0.4583
y	0.4199
u'	0.2574
v'	0.5306
CRI	80.00
CCT	2794
Duv	0.00356

R Values

R1	78.10
R2	85.54
R3	93.21
R4	80.56
R5	76.96
R6	81.13
R7	84.69
R8	59.60
R9	5.46
R10	66.92
R11	79.43
R12	62.25
R13	79.07
R14	95.56

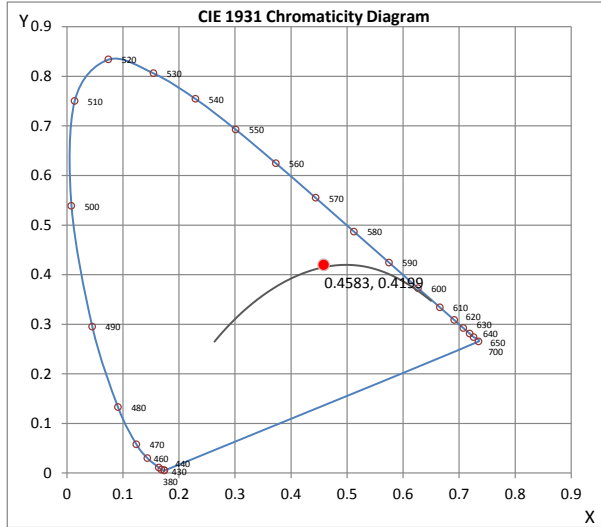

*All Results in accordance to IESNA LM-79-2008: Approved Method for the Electrical and Photometric Testing of Solid-State Lighting.



8165 E Kaiser Blvd. Anaheim, CA 92808
 p. 714.282.2270
 f. 714.676.5558

Date: 12/9/2014



NVLAP LAB CODE 200927-0

Test Methods

Photometric Measurements - Goniophotometer

A Custom Light Laboratory Type C Rotating Mirror Goniophotometer was used to measure candelas(intensity) at each angle of distribution as defined by IESNA for the appropriate fixture type.

Ambient temperature is set to 25°C and is measured from the center of the fixture, within 1ft from the outside of the fixture. Temperature is maintained at 25°C throughout the testing process and the sample is stabilized for at least 30mins and longer as necessary for the sample to achieve stabilization.

Electrical measurements are measured using the listed equipment.

Spectral Measurements - Integrating Sphere

A Sensing Spectroradiometer SPR-3000, in conjunction with Light Laboratory 2 meter integrating sphere was used to measure chromaticity coordinates, correlated color temperature(CCT) and the color rendering index(CRI) for each sample.

Ambient temperature is set to 25°C and is measured from the center of the fixture, within 1ft from the outside of the fixture. Temperature is maintained at 25°C throughout the testing process and the sample is stabilized for at least 30mins and longer as necessary for the sample to achieve stabilization.

Electrical measurements are measured using the listed equipment.

Disclaimers:

This report must not be used by the customer to claim product certification, approval or endorsement by NVLAP, NIST or any agency of Federal Government.

Report Prepared by : Keyur Patel

Test Report Released by:

Jeff Ahn
 Engineering Manager

Test Report Reviewed by:

Steve Kang
 Quality Assurance

*Attached are photometric data reports. Total number of pages: 8

*All Results in accordance to IESNA LM-79-2008: Approved Method for the Electrical and Photometric Testing of Solid-State Lighting.

Photometric Test Report

IES FLOOD REPORT
PHOTOMETRIC FILENAME : L111407103.IES

DESCRIPTIVE INFORMATION (From Photometric File)

IESNA:LM-63-2002
[TEST] L111407103
[TESTLAB] LIGHT LABORATORY, INC.
[ISSUEDATE] 12/09/2014
[MANUFAC] CAST LIGHTING
[LUMCAT] CCSL18336
[LUMINAIRE] 2"DIA. X 12-1/2"H. LED LUMINAIRE
[MORE] CLEAR LENS
[BALLASTCAT] N.A.
[BALLAST] N.A.
[LAMPPOSITION] 0,0
[LAMPFCAT] N/A
[OTHER] INDICATING THE CANDELA VALUES ARE ABSOLUTE AND
[MORE] SHOULD NOT BE FACTORED FOR DIFFERENT LAMP RATINGS.
[INPUT] 12VAC, 2.69W
[TEST PROCEDURE] IESNA:LM-79-08

Note: Candela values converted from Type-C to Type-B

CHARACTERISTICS

NEMA Type	4 H x 4 V
Maximum Candela	417.99
Maximum Candela Angle	0H 0V
Horizontal Beam Angle (50%)	34.1
Vertical Beam Angle (50%)	34.1
Horizontal Field Angle (10%)	55.6
Vertical Field Angle (10%)	55.1
Lumens Per Lamp	N.A. (absolute)
Total Lamp Lumens	N.A. (absolute)
Beam Lumens	85
Beam Efficiency	N.A.
Field Lumens	131
Field Efficiency	N.A.
Spill Lumens	22
Luminaire Lumens	153
Total Efficiency	N.A.
Total Luminaire Watts	2.69
Ballast Factor	1.00

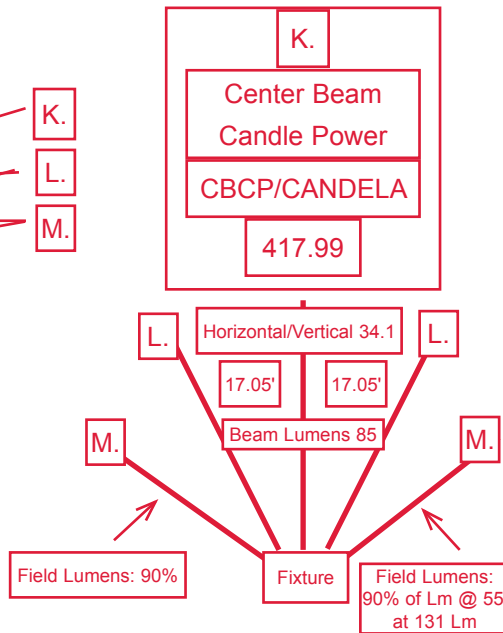

AXIAL CANDELA

DEG.	HOR.	DEG.	VERT.
90	0	90	0
85	0	85	0
75	.08	75	0
65	1.17	65	0
55	3.44	55	.5
47.5	5.28	47.5	3.69
42.5	6.54	42.5	6.04
37.5	9.98	37.5	8.22
33	17.95	33	13.74
29	33.24	29	25.94
25.5	57.81	25.5	47.56
22.5	94.51	22.5	82.52
19.5	155.08	19.5	142.59
17	210.54	17	197.19
15	254.95	15	239.51
13	293.13	13	275.17
11	326.14	11	307.77
9	354.42	9	337.77
7	378.29	7	365.21
5	398.02	5	389.63
3	409.49	3	405.23
1	415.74	1	414.45
0	417.99	0	417.99
-1	415.74	-1	417.28
-3	409.49	-3	414.53
-5	398.02	-5	407.75
-7	378.29	-7	391.81
-9	354.42	-9	370.2
-11	326.14	-11	343.06
-13	293.13	-13	310.34
-15	254.95	-15	271.72
-17	210.54	-17	224.67
-19.5	155.08	-19.5	167.06
-22.5	94.51	-22.5	105.84
-25.5	57.81	-25.5	65.3
-29	33.24	-29	38.97
-33	17.95	-33	21.56
-37.5	9.98	-37.5	11.07
-42.5	6.54	-42.5	6.88
-47.5	5.28	-47.5	6.21
-55	3.44	-55	4.03
-65	1.17	-65	1.34
-75	.08	-75	.5
-85	0	-85	.17
-90	0	-90	.17

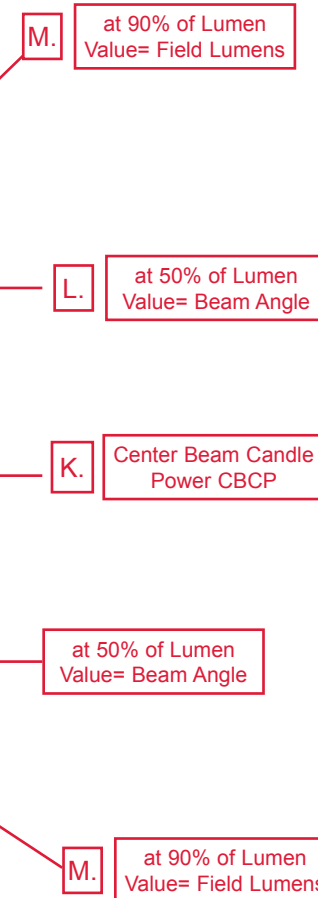

AXIAL CANDELA DISPLAY

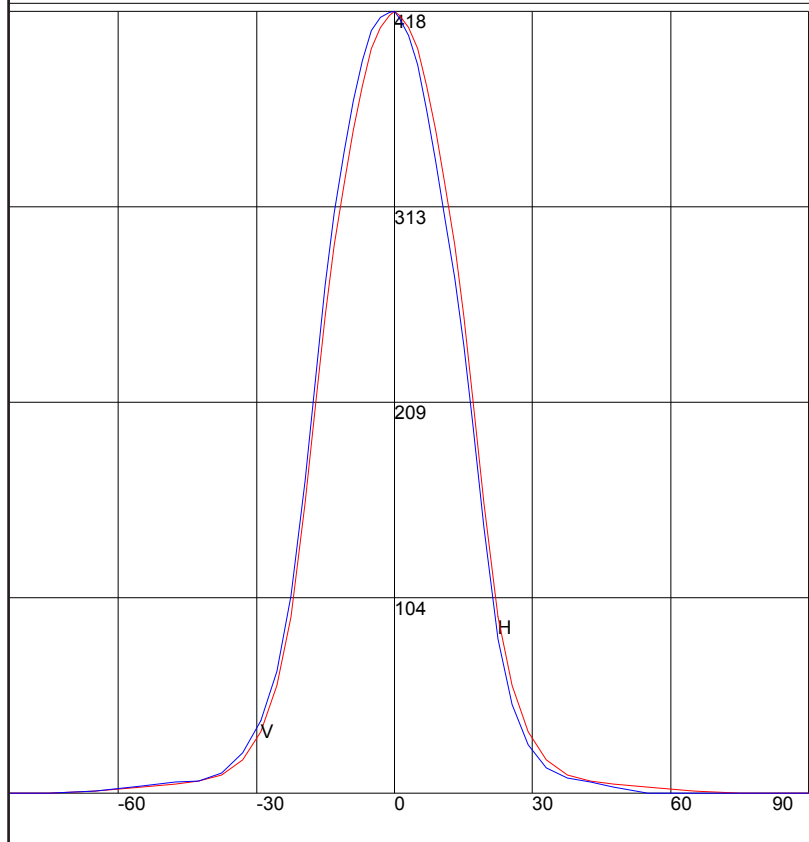

Maximum Candela = 417.99 Located At Horizontal Angle = 0, Vertical Angle = 0
Horizontal Axial Candela
Vertical Axial Candela

CANDELA CURVES

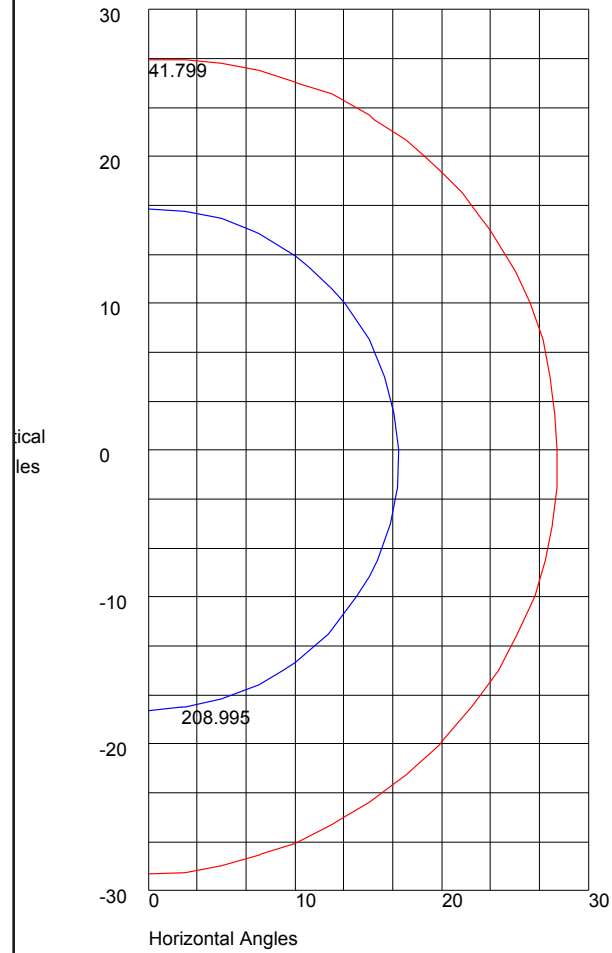

Maximum Candela = 417.99 Located At Horizontal Angle = 0, Vertical Angle = 0
Maximum Candela = 208.995
Maximum Candela = 41.799

Illumination Engineering Society (IES) standards for testing.

LM-80: the testing of a LED chip by a manufacturer of the chip to extrapolate lamp life expressed in hours of operation.

L-70: Lumen Maintenance. The point at which a LED chip's light output reduces by 30% in hours of operation at which point the chip is considered dead. (Even though the LED could still be operating) This was chosen because your eye can only notice a 30% decrease in light level.

LM-79 The testing of the electrical and photometric measurement of solid state lighting products by a third party laboratory to determine performance as specified by the IES (Illumination Engineering Society)

Lumens= (lm) Is the measure of the total amount of visible light emitted by a source.

Candela. (cd) also referred to as Center Beam Candela (Candle) Power (CBCP). This is the base unit of luminous intensity; that is, power emitted by a light source at the dead center of the beam angle.

High Power Light Emitting Diode. This is a high efficiency Light Source made up of two different materials that when stimulated with DC current emit photons of blue light.

Phosphor Coating: A coating placed over the LED to create a specific color (Kelvin Temperature)

Collimating Optic: A molded uv resistant plastic that fits over an LED designed to focus the light produced by a LED into a specific beam pattern or cone of light.

Foot Candle. Is equal to one lumen per square foot. Or approximately 10.74 lux

Correlated Color Temperature (CCT) Kelvin. The color output of a source of light. (Ex. 2700 to 2800K warm white)

Color Rendering Index. (CRI) is a quantitative measure of the ability of a light source to reveal the colors of various objects faithfully in comparison with an ideal or natural light source. The higher the CRI the better the source in color critical applications.

Color Shift: The change of the led output color over time usually occurring from overheating and poor thermal management of the led and poor led material used in initial production of the led. This is a problem when a lamp fails after installation and a replacement is installed the color is vastly different and the customer notices.

Optical performance:

Beam Angle: The angle from 90' off center. 40' beam is 20' of center both right and left side.

Striations: Lines or scratches formed in the optical pattern creating jagged usually black lines throughout the light pattern typically emanating from center to edge.

Halo: A glow or dark ring around the edges of a light beam in varying widths and densities interrupting an otherwise clean bleed off of light.

Color Consistency: The led's ability to project a clean uniform color across the entire surface of the beam without stray columns of differing light color appearing in the projected light pattern.

MacAdam Ellipse: This is the study of color vision and refers to the region on a chromaticity diagram. The led chips that have a tight "Binning" will deliver a very consistent color across the led manufactured to a tight chip binning specification. This insures that the first LED produced and the LED produced five years from now to that specification will be the same and the customer will see no difference in light color. Low quality led's will vary in color in the same production run because of loose binning requirements. Since your eye can detect a 3% variation in color difference tight binning is extremely important with led manufacturing.

Lumens Per Watt: The amount of light delivered for dollars paid per hour to operate a LED. This is a measure of efficiency.

Drive Circuits:

Power Factor (pf) / Volt Amps: This is the inefficiency of the DC driver to convert the AC power to DC power and the need to compensate for this by using a larger transformer. Example CPWP1 .82pf input power is 7.0 watts Apparent power is 8.5 Watts. The customer must size the transformer using 8.5 watts. (note: the customer only pays for the 7.0 watts of electricity used)

Cost to Operate a System: Take an amp probe and measure the primary amps on the system. Divide this number by 1000. Multiply this number by the electrical rate expressed in KWH kilowatt hour. (ie .15c kwh) to determine the cost per hour to run the system. Multiply by hours on per night, week, year to determine operating cost.

Surge Protection: The ability of a solid state circuit to handle a prolonged increase in voltage above normal operating conditions. Surge protectors can also be installed on the primary side of a transformer to add additional protection from line spike problems.

Transient Spike Protection: The ability of a solid state circuit to handle quick spikes in voltage above normal operating conditions.

Operating Range: The range in input voltage a solid state circuit is designed to operate on. Cast lighting 8-24VAC or VDC

FCC Class A & B radiated emissions. The design of a solid state circuit and testing of the final design by an accredited laboratory eliminating any radio interference that the circuit could emit which could interfere with household appliances such as garage door openers, wi-fi, remote controls, life safety equipment etc.

Aluminum electrolytic capacitors: An inexpensive low life electrical component used to store energy and deliver to an LED a consistent DC power supply. Without this the led would rapidly blink.

Conformal Coatings: This is a sealant placed over a circuit board to protect the solder joints, resistors etc from moisture and intrusion by the elements.

Electrical Component Selection: *Voltage range and operating temperature* of the solid state components determine the longevity of the circuit and the ultimate cost of the product. You get what you pay for.

E-Waste: (Electronic waste). The needless accumulation of failed solid state circuits in landfills, caused by irresponsible manufacturers producing products and distributors selling products that will fail sooner than they should. These products could be designed differently but are not. This is done with the goal of making a fast buck and fooling the users into believing the products are better than actually designed.

Thermal Management: The ability to transfer heat generated from the LED to the outside of the fixture in order to provide an operating temperature that does not overheat the led and achieve the L-70 life of the LED.

Overheating a LED: If a led is driven too hard with DC current the led will produce bright light initially but the overheating will cause the LED after a half hour or so to diminish in light output and diminish the life of the led and the brightness level considerably. This also causes color shift which causes variations in the color output from fixture to fixture on a job. This can also lead to catastrophic failure in a short time span.

Thermal Fold Back: The monitoring of an led's operating temperature to make sure it does not overheat and damage the led. If the led does reach overheat conditions the drive circuit powering the leds reduces the current to a point where the operating temperature is acceptable thus eliminating potential heat damage to the led's.

A Light Engine: The integrated combination of both the drive circuit and the led into one component usually affixed to a luminaire.

Junction Temperature: This is the highest operating temperature of the actual semiconductor (LED) in an electronic device. This is higher than the case temperature and the temperature of the parts exterior. The measurement of the amount of heat transferred from the junction multiplied by the junction to case thermal resistance. Since it is impossible to measure behind a led that is affixed to a FR4 (green fiberglass electronic board) or aluminum board a scientific formula is used to determine the temperature behind the led. This is the temperature that is used to determine the life of the led over time.

Thermal Couple: This is a two wire probe that is attached to a led board and elsewhere on the fixture to determine operating temperature during testing. This thermal couple can also be integrated in a circuit board for the purpose of monitoring heat conditions of a solid state circuit board.

Thermal Path: The ability to move the LED heat from the led inside the fixture to the outside air.

Gap Pad: This is a thermally conductive gasket like material usually .010” thick used to bond a led board to the underlying fixture body or casting. The purpose is to dissipate heat generated by the LED.

Thermal Grease: This is a thermally conductive grease material used to bond a led board to the underlying fixture body or casting. The purpose is to dissipate heat generated by the LED.

Thermal Trap: A led light engine that has no way of dissipating the heat generated by a led and driver to the exterior surface of a fixture. This is most common with Drop In Mir 16 LED lamps which are encased in a pocket of air in an old style halogen fixture with little or no thermal path to the exterior of the fixture.

Pulse-width modulation (PWM) dimming: This is a way to control the power supplied to an electrical device by essentially controlling the width (number) of wave forms supplying a transformer. This PWM dimming can be used on the primary power supply feeding a cast toroid transformer powering any cast led fixture to allow dimming of the led’s manually by a homeowner. The PWM dimmer must be a MLV (magnetic Low Voltage dimming style only NOT and electronic PWM dimmer)

Toroid: A circular magnetic winding that takes primary power and depending on the number of windings of copper wire create a magnetic field that inducts a power on the secondary to produce a low voltage current which can be 12,13,14,15,16.....etc. volts. A toroid is a far more efficient winding than a comparable EI style transformer. Toroid’s usually operate in the 93% efficiency range. Cast Lighting will not warranty any LED product over one year that is not run on a cast lighting transformer because poorly manufactured EI transformers create uneven power that can cause spikes and damage LED driver circuitry.

Transformer efficiency: The efficient use of the electrical current to produce a low voltage current. A 93% efficient transformer uses 7% of the power consumed to create the low voltage power.

A Driver: This is a electrical circuit board made up of components that take the AC (alternating Current power) and turn the AC power into DC power which then is used to drive the LED. Cast Lighting has the driver placed in the fixture next to the LED.

Drop-in LED products. This term defines a series of led light engines (Engine is a driver and led together) that fit into existing legacy of old halogen products. Drop-Ins take the place if MR16, MR11, Par 36, S-8 and other halogen lamp form factors. These drop-in products for the first time in lighting history has the fixture determined the lamp form factor. In the past a lamp was developed and the fixture manufacturers *designed around the lamp*.

Legacy Fixture. These are fixtures using old halogen and incandescent lamp designs such as MR-16, MR-11, Par-36, S-8, SCB etc.

Why Take the RISK?

- Halogen Fixtures were NEVER designed for LEDs
- Hot LEDs = Hot Driver = Predictable Failure

Holds Heat

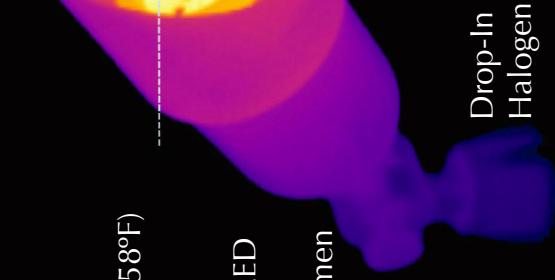

70°C (158°F)
PCB

MR16 LED
5.7W
303 Lumen

Manages Heat

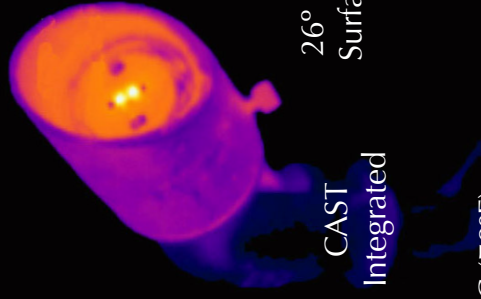

44°C (111°F)
PCB

CAST LED
4.3W
229 Lumen

26° C (78°F) Lower
Surface Temperature

Ambient Ta= 21°C (70°F)

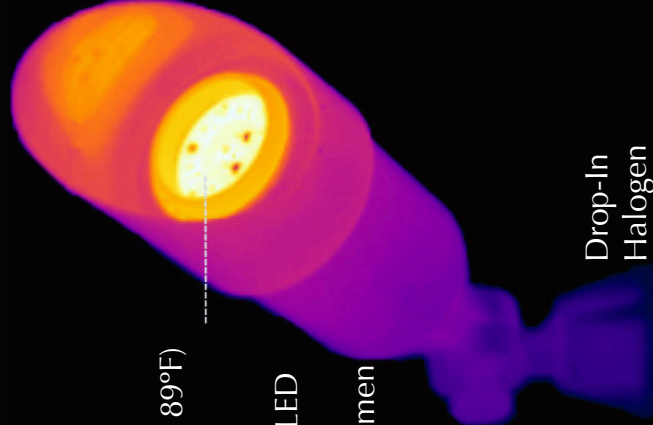

87°C (189°F)
PCB

MR16 LED
7.4W
271 Lumen

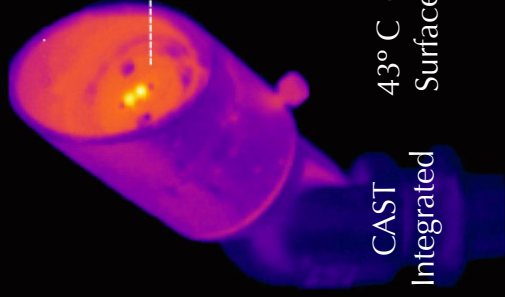

44°C (111°F)
PCB

CAST LED
4.3W
229 Lumen

43° C (109°F) Lower
Surface Temperature

Ambient Ta= 21°C (70°F)



CAST LED Fixtures... Designed for the Technology.

Order # CLTM
\$19.95 USD

