

Bestway®



58388E

OWNER'S MANUAL

bestwaycorp.com/support

Visit Bestway YouTube channel 

FILTER PUMP OWNER'S MANUAL

WARNING IMPORTANT SAFETY INSTRUCTIONS

When installing and using this electrical equipment, basic safety precautions should always be followed, including the following:

READ AND FOLLOW ALL INSTRUCTIONS

WARNING - TO REDUCE THE RISK OF INJURY, do not permit children to use this product unless they are closely supervised at all times.

WARNING - RISK OF ELECTRIC SHOCK. Connect only to a grounding type receptacle. This product is provided with a ground-fault circuit-interrupter. If replacement of the plug is needed, use only identical replacement parts.

WARNING: The unit is provided with a ground-fault circuit-interrupter (**GFCI**). To test the **GFCI**, push the test button. The **GFCI** should interrupt power. Push the reset button. Power should be restored. If the **GFCI** fails to operate in this manner, the **GFCI** is defective. If the **GFCI** interrupts power to the pump without the test button being pushed, a ground current is flowing, indicating the possibility of an electric shock. Do not use this pump. Disconnect the pump and have the problem corrected by a qualified service representative before using.

CAUTION - To reduce the risk of electric shock the pool must be installed no closer than 6 feet (1.8 m) from any electrical outlet. Do not place portable appliances closer than 5 feet (1.5 m) from the pool.

WARNING: The pump is not intended to be bonded to the equipotential bonding grid. **DO NOT BURY CORD.** Locate cord to minimize abuse from lawn mowers, hedge trimmers, and other equipment.

WARNING - To reduce the risk of electric shock, **IF FILTER PUMP POWER CORD BECOMES DAMAGED IN ANY WAY, THE PUMP MUST BE DISCARDED.**

WARNING - To reduce the risk of electric shock, do not use extension cord to connect unit to electric supply; provide a properly located outlet.

CAUTION - This pump is for use with storable pools only. Do not use with permanently-installed pools. A storable pool is constructed so that it is capable of being readily disassembled for storage and reassembled to its original integrity. A permanently-installed pool is constructed in or on the ground or in a building such that it cannot be readily disassembled for storage.

CAUTION - For continued protection against possible electric shock this unit is to be mounted to the base in accordance with the installation instructions.

IMPORTANT - Using the pump with an unmatched electrical supply is dangerous and will result in catastrophic failure of pump.

RISK OF ELECTRIC SHOCK - When working with electricity, turn the electrical power off at the circuit breaker and lock breaker door. Failure to do so will result in increased risk of shock, injury and possibly death.

DO NOT REMOVE THE GROUNDING PRONG OR MODIFY THE PLUG IN ANY WAY. DO NOT USE ADAPTOR PLUGS. Consult a qualified electrician for any questions related to the validity of your plugs grounding. Handle the pump with care. Do not pull or carry the pump by the power cord. Never pull a plug from the outlet by yanking the power cord. Keep cord free from abrasions. Sharp objects, oil, moving parts, and heat should never be exposed to the filter pump.

NOTE: Please examine equipment before use. Notify Bestway at the customer service address listed on this manual for any manufacturing defect or missing parts at the time of purchase. Verify that the equipment components represent the filter pump model that you had intended to purchase.

NOTE: Place pump on a solid and level ground. Pay attention to position of pool and pump so adequate ventilation, drainage, and access for cleaning is available. Never place pump in an area that may accumulate water, or in an area where foot traffic will flow around the pool.

NOTE: Atmospheric conditions may affect the performance and life span of your filter pump. Unnecessary wear and tear may occur during periods of cold, heat and exposure to sun. Whenever possible shelter the pump from these conditions.

NOTE: Do not add chemicals in the filter pump.

NOTE: Assembly and disassembly of this product should only be performed by adults.

- THERMALLY PROTECTED MOTOR CSA ENCLOSURE 3
- FOR USE WITH SWIMMING POOLS ONLY.

• **CAUTION:** TO ENSURE CONTINUED PROTECTION AGAINST SHOCK HAZARD, USE ONLY IDENTICAL REPLACEMENT PARTS WHEN SERVICING.

• **WARNING:** RISK OF ELECTRIC SHOCK. CONNECT ONLY TO A GROUNDING TYPE RECEPTACLE.

• **CAUTION:** THIS PUMP IS FOR USE WITH STORABLE POOLS ONLY - DO NOT USE WITH PERMANENTLY-INSTALLED POOLS.

• **CAUTION:** CONNECT ONLY TO GROUNDING TYPE RECEPTACLE PROTECTED BY A CLASS A GROUND FAULT CIRCUIT INTERRUPTER.

• **CAUTION:** FOR CONTINUED PROTECTION AGAINST POSSIBLE ELECTRIC SHOCK THIS UNIT IS TO BE MOUNTED TO THE BASE IN ACCORDANCE WITH THE INSTALLATION INSTRUCTIONS.

• **WARNING** - RISK OF ELECTROCUTION

- 1) Connect Only To Properly Grounded Outlet. Do Not Remove Ground Pin

- 2) Inspect Cord Before Using – Do Not Use If Cord Is Damaged.
- 3) Keep Ground-Fault Circuit-Interrupter Dry And Off The Ground
- 4) Do Not Touch Plug With Wet Hands
- 5) Double Insulated – When Servicing Use Only Identical Replacement Parts.
- 6) Read Instruction Manual Before Using.

DO NOT REMOVE THIS TAG

SAVE THESE INSTRUCTIONS.

This device complies with part 15 of the FCC Rules. Operation is subject to the following two conditions: (1) This device may not cause harmful interference, and (2) this device must accept any interference received, including interference that may cause undesired operation.

WARNING: Any changes or modifications to this unit not expressly approved by the party responsible for compliance could void the user's authority to operate the equipment.

NOTE: This equipment has been tested and found to comply with the limits for a Class B digital device, pursuant to part 15 of the FCC Rules. These limits are designed to provide reasonable protection against harmful interference in a residential installation. This equipment generates, uses and can radiate radio frequency energy and, if not installed and used in accordance with the instructions, may cause harmful interference to radio communications. However, there is no guarantee that interference will not occur in a particular installation. If this equipment does cause harmful interference to radio or television reception, which can be determined by turning the equipment off and on, the user is encouraged to try to correct the interference by one or more of the following measures:

- Reorient or relocate the receiving antenna.
- Increase the separation between the equipment and receiver.
- Connect the equipment into an outlet on a circuit different from that to which the receiver is connected.
- Consult the dealer or an experienced radio/ TV technician for help.

GFCI WARNING

WARNING: Risk of electric shock. The GFCI must be tested before each use.

WARNING: Before inserting plug into a power outlet, make sure the current rate of the power outlet is suitable for the pump.

WARNING: Do not use the pump if this test fails. For assistance, please visit the support section on our website, www.bestwaycorp.com.

IMPORTANT: To prevent the risk of electrical shock, ensure your hands are completely dry when plugging-in the Filter Pump.

IMPORTANT: Do not dry run the filter pump. Make sure both the pool's Inlet and Outlet valves are fully covered by water before operating the Filter Pump.

POOL SUCTION FITTING INSTRUCTIONS

When installing and using this equipment, basic safety precautions shall always be followed, including the following:

IMPORTANT SAFETY INSTRUCTIONS READ, FOLLOW, AND UNDERSTAND ALL INSTRUCTIONS AND WARNINGS.

- Any modification that increases the flow rate of the circulation system shall require re-evaluation of the cover/grate and sump to ensure that the flow rating of the Suction Outlet Fitting Assembly (SOFA) is not exceeded.
- Missing, broken, or cracked cover/grates, sumps, mud-frames, or any other SOFA component shall be replaced before bathers are allowed to use the pool.
- Loose cover/grates shall be reattached before bathers are allowed to use the pool.

1. Replace suction fittings every 2 years.
2. The use of adhesives or other attachment methods that prevent access to suction piping or SOFA components requiring periodic servicing is prohibited.
3. Refer to the following diagram for each SOFA component part instructions:
4. - Any field modification made to a SOFA not authorized by the manufacturer's installation instructions shall void the SOFA certification.
 - No modification shall be made to a SOFA structure or flow path unless the new configuration has been certified as new SOFA.
 - Cover/grates and all other SOFA components shall be replaced at or before the end of their service life and that service life begins the month and year in which a SOFA component is installed with or without water.
5. Winterizing instructions. Dry the suction fittings completely, and store the product in a dry room at a storage temperature of 15 °C ~ 40 °C.
6. Use the screwdriver (not included) to disassemble the suction fitting to clean or service.
 - Cover/grate, including fasteners, shall be observed for damage or tampering each operational day.
 - Missing, broken, or cracked cover/grates shall be replaced before bathers are allowed to use the pool.
 - Loose cover/grates and associated components shall be reattached before bathers are allowed to use the pool.

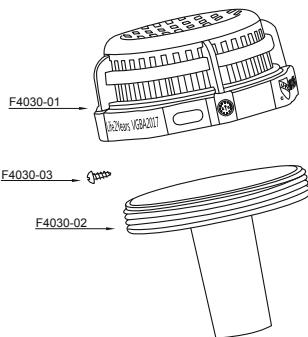

- SOFA components and fastener receptacles shall be clean and free of debris or obstructions during installation of cover/grate and fasteners.
 - Remember to hand-check cover/grate for snugness to the sump/ frame after installation.
7. Before using the product, please check the integrity of the head of the suction fitting. If the product is broken, please do not use it.
8. - All SOFAs shall be installed in accordance with the manufacturer's installation instructions.
- No modification shall be made to a SOFA structure or flow path unless the new configuration has been certified to the original SOFA.
 - These SOFA-configuration specific flow ratings NOT be exceeded at any time the pool is open to bathers.
 - Cover/grates, when installed, shall not protrude more than 2 in. (51 mm) from the finished surface of the pool in which the SOFA is installed
- 9.

Installation Information label (copy)

Manufacturers name:
GOLEADER INDUSTRIES (JINHUA) CO., LTD.
Cover part number: F4030
Service life of the cover: 2 Years
Cover flow rating: 28 GPM
Installer need to fill in the balance of information and give it to the pool owner, to be kept with other important pool related documents.
Configuration and installed orientation: _____
Location: _____
Installed Date: _____

Please research and download General Certificate of Conformity through www.bestwaycorp.com

SAVE THESE INSTRUCTIONS

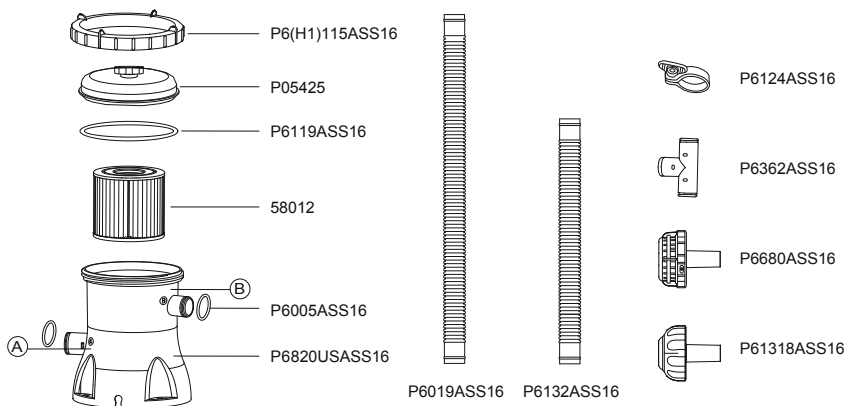

	A	B	C
P05425	1	1	1
P6(H1)115ASS16	1	1	1
P6119ASS16	1	1	1
58012	1	1	1
P6820USASS16	1	1	1
P6019ASS16	2	2	2
P6132ASS16	2	2	0
P6124ASS16	8	5	2
P6005ASS16	5	5	2
P6362ASS16	1	1	0
P6680ASS16	2	0	0
P61318ASS16	1	0	0

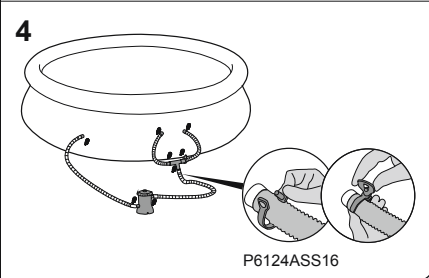
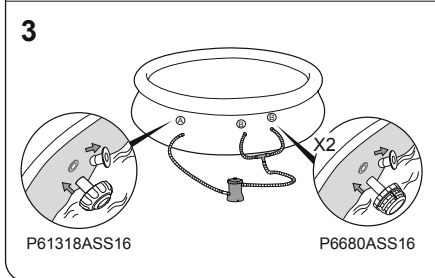
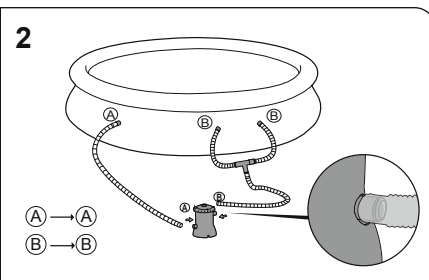
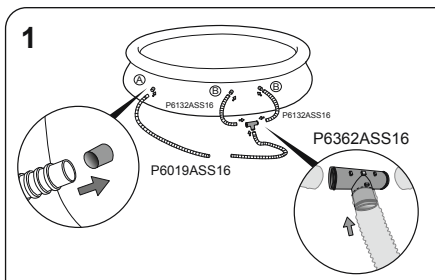
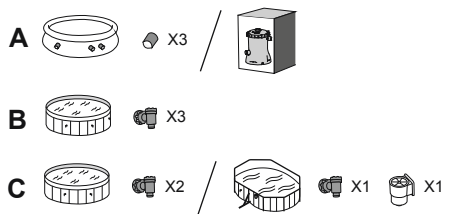

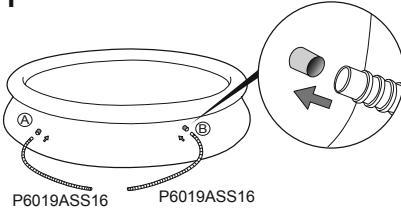
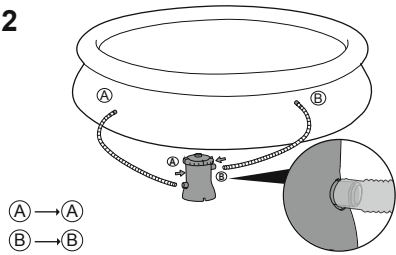
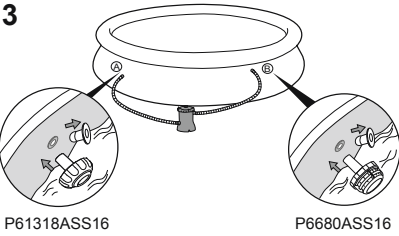
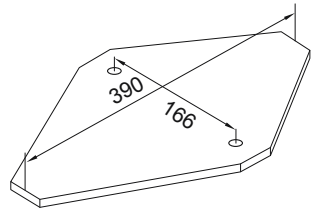
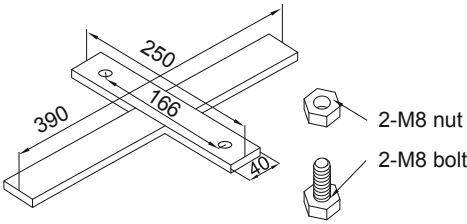
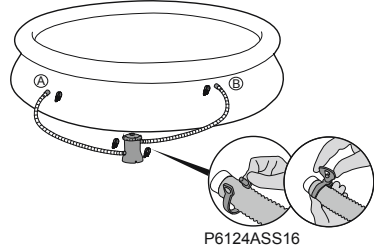
1**2****3****4****PEDESTAL FIXING**

The filter pump must be vertically fixed on ground or a certain pedestal made of wood or concrete before use. There should be two holes 9mm in diameter on the pedestal, the space between which should be 166mm. Put filter pump on the pedestal and fix them together by fasten the bolts and nuts. All the pedestal parts should weigh over 18kgs at least to prevent the pump from accidentally falling.

NOTE: It is important to ensure all elements: Hoses, Debris Screens and Inlet/Outlet Valves are properly aligned.

OPERATION

1) Open/unscrew the Air Purge Valve on the top of the Filter Pump; air is released as water fills the Filter Pump.

NOTE: If knob should become dislodged, simply place it back into the hole and turn clockwise to rethread air purge valve.

2) When water comes out of the Air Purge Valve screw it closed and wipe away any water.

3) Test the GFCI plug.

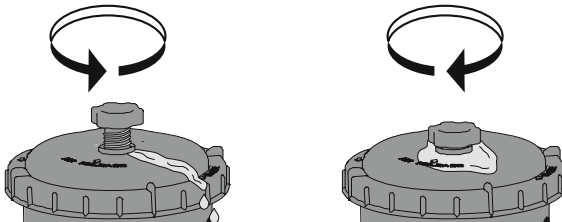

NOTE: It is imperative to check that the hydraulic connectors are not closed.

GFCI TEST

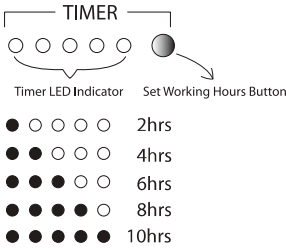
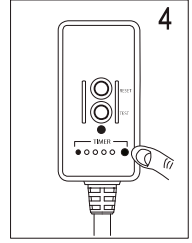
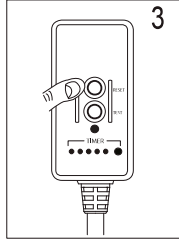
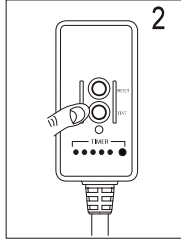
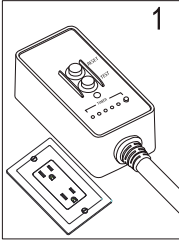

Each LED indicator represents 2 hours of working time. You can push the Set Working Hours Button to adjust the desired time.

IMPORTANT:

1. After setting the run time, the pump will restart automatically at the same time the following day.
2. In case of a power outage or the GFCI being unplugged, the running time of the product will be reset to a 10 hour default and the previous set will be deleted.
3. After finishing the working time, the GFCI goes into stand-by mode. During this time, all LED indicators will be off.
4. Pushing the test button on the GFCI does not stop the timer. To stop the timer, you have to unplug the GFCI.

PUMP MAINTENANCE

CAUTION: YOU MUST ENSURE THE FILTER PUMP IS UNPLUGGED BEFORE ANY MAINTENANCE OR STORAGE BEGINS OR SEVERE RISK OF INJURY OR DEATH EXISTS.

- 1) Unplug the Filter Pump.
- 2) Loosen the Hose Clamps on the pool's Inlet and Outlet Hoses by unscrewing the fly nut counter-clockwise.
- 3) Remove Debris Screens from the inside of the pool.
- 4) Replace the Debris Screens with the Stopper Plugs in the pool's Inlet and Outlet Valves.
- 5) Unscrew the Filter Cap Retainer and remove the Filter Cap.
- 6) Clean the Filter Cartridge with a garden hose, if filter cartridge remains soiled or discolored, it is necessary to replace it with a new one.
- 7) Insert the cleaned (or new) Filter Cartridge; ensure it is centered in the Filter Pump.
- 8) Check that the Filter Cap Seal is in place.
- 9) Replace the Filter Cap and screw the Filter Cap Retainer into position.
- 10) Replace the Stopper Plugs with the Debris Screens in the pool's Inlet and Outlet Valves. Tighten the Hose Clamps.
Water will now flow to the pump.
- 11) Follow the PUMP INSTALLATION DIRECTIONS section to prepare the system for use.

IMPORTANT: For sanitary reasons we suggest replacing the Filter Cartridge with a new one every two weeks.

PUMP STORAGE

- 1) Unplug the Filter Pump.
- 2) Follow the instructions as previously outlined to stop water flowing to the Filter Pump and to remove the Filter Cartridge.
- 3) Discard the Filter Cartridge.
- 4) Detach all Hoses.
- 5) Dry all components thoroughly.
- 6) Store the filter pump in a dry location out of the reach of children.
Storage temperature: 4-40°C (39.2-104°F)

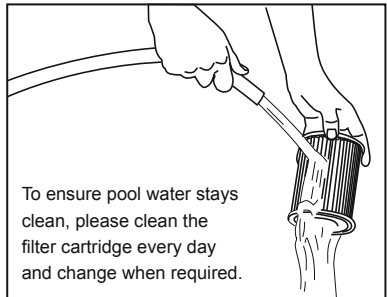

PUMP WARRANTY

For information concerning pump warranty please visit our website at: www.bestwaycorp.com

For support please visit us at:
bestwaycorp.com/support

©2021 Bestway Inflatables & Material Corp.

All rights reserved/Tous droits réservés/Todos los derechos reservados/Alle Rechte vorbehalten/Tutti i diritti riservati

Trademarks used in some countries under license from/

Marques utilisées dans certains pays sous la licence de/

Marcas comerciales utilizadas en algunos países bajo la licencia de/

Die Warenzeichen werden in einigen Ländern verwendet unter Lizenz der/

Marchi utilizzati in alcuni paesi concessi in licenza a

Bestway Inflatables & Material Corp., Shanghai, China

Manufactured, distributed and represented in the European Union by/

Fabriqué, distribué et représenté dans l'Union Européenne par/Fabricado, distribuido y representado en la Unión Europea por/

Hergestellt, vertrieben und in der Europäischen Union vertreten von/Prodotto, distribuito e rappresentato nell'Unione Europea da

Bestway (Europe) S.r.l., Via Resistenza, 5, 20098 San Giuliano Milanese (Milano), Italy

Distributed in Latin America by/Distribuído en América latina por/Distribuido en Latinoamérica por/Distribuído na América Latina por

Bestway Central & South America Ltda, Salar Ascotan 1282, Parque Enea, Pudahuel, Santiago, Chile

Distributed in Australia & New Zealand by **Bestway Australia Pty Ltd, Unit 2/98-104 Carnarvon St Silverwater, NSW 2128, Australia**

Tel: Australia: (+61) 29 0371 388; New Zealand: 0800 142 101

Distributed in United Kingdom by **Bestway Corp UK Ltd, 8 Wentworth Road, Heathfield Industrial Estate, Newton Abbot, Devon, TQ12 6TL**

Exported by/Exporté par/Exportado por/Exportiert von/Esportato da

Bestway (Hong Kong) International Ltd./Bestway Enterprise Company Limited

Suite 713, 7/Floor, East Wing, Tsim Sha Tsui Centre, 66 Mody Road, Kowloon, Hong Kong

Tel: +86 21 69135588 (For U.S. and Canada)

www.bestwaycorp.com

Bestway